

大嘴鳥

作者SAGA CHAN

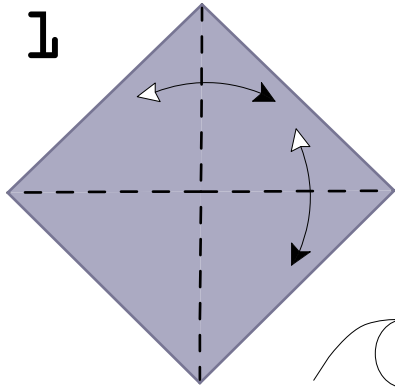

對摺再還原

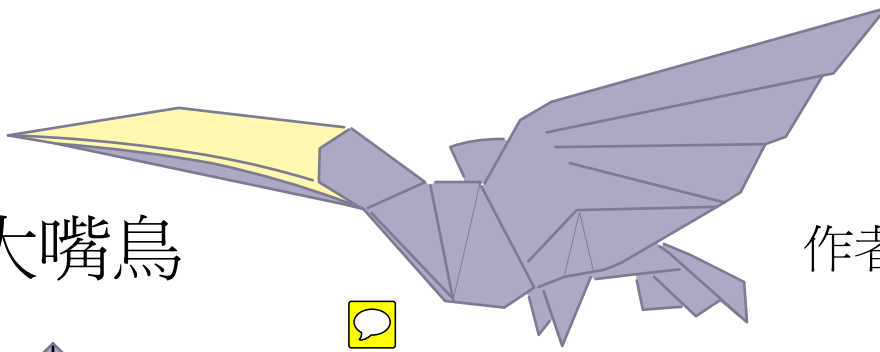
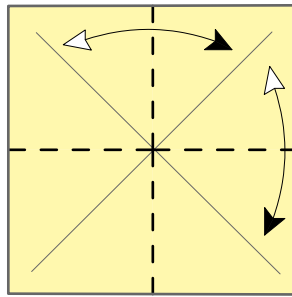

對摺再還原

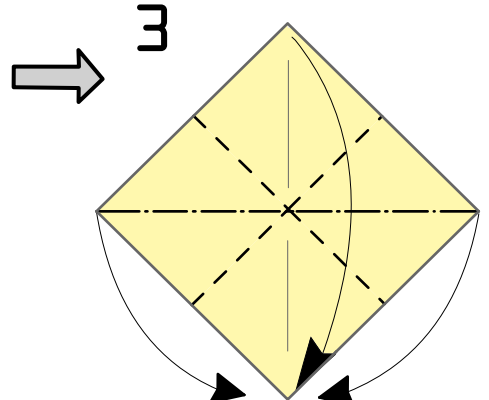

摺成小正方

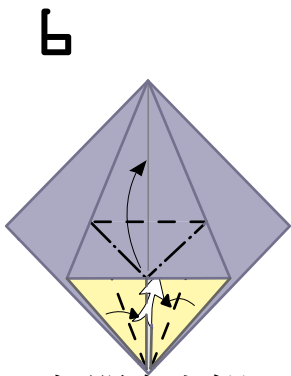

打開向上摺

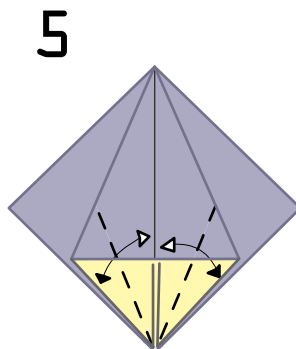

向中摺後還原

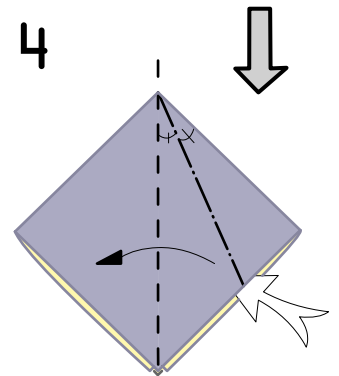

分中及壓平

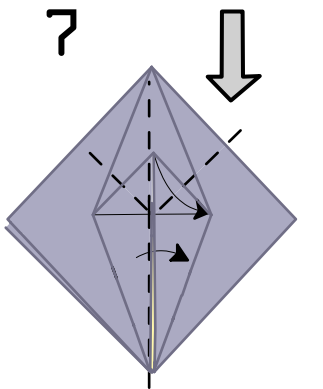

向右摺，小三角同樣向右摺

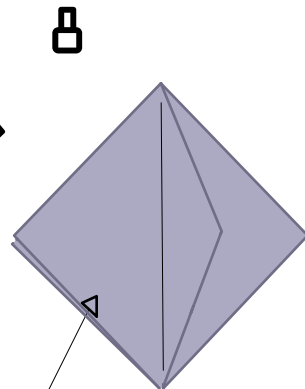

做同一摺法

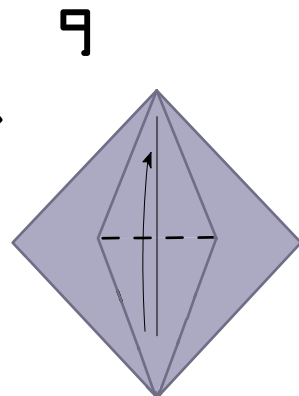

三角形向上摺

10

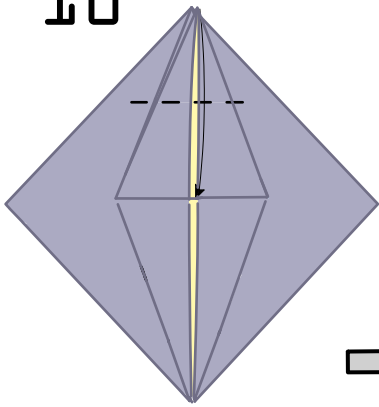

上角對中央摺



11

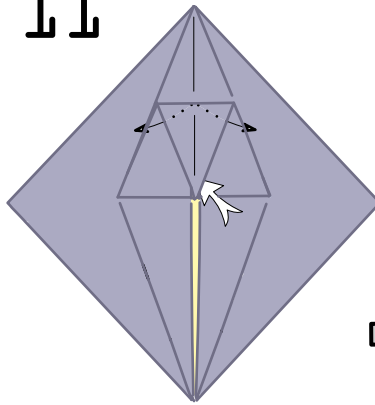

內幅向外拉開

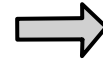

12

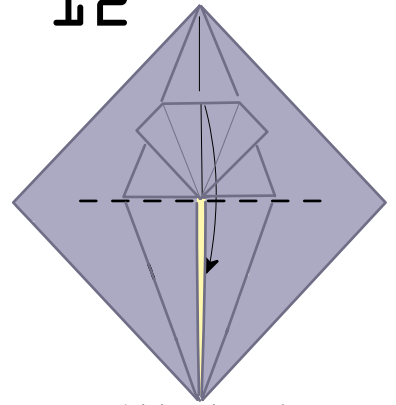

前幅向下摺

15

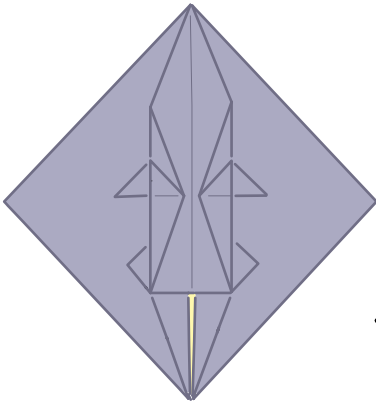

轉到後方

14

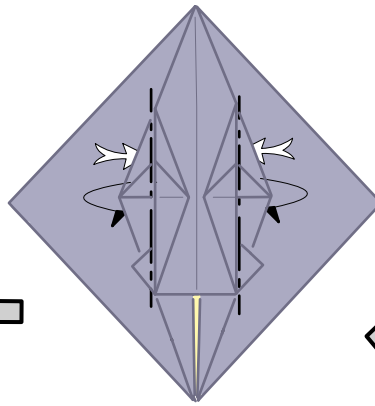

兩邊向後摺



13

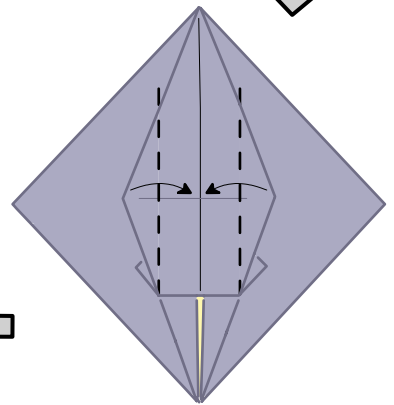

對中央摺

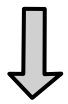

16

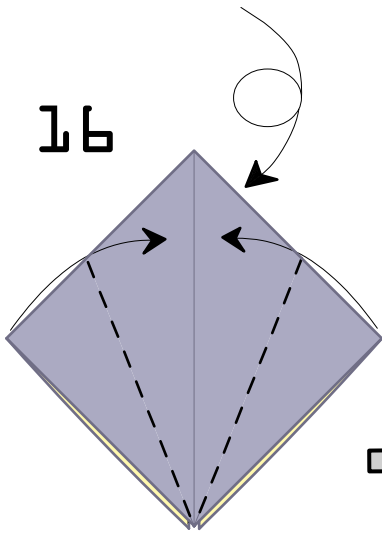

對角摺到中央



17

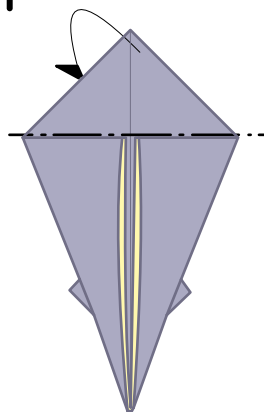

上角摺向後

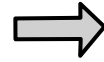

18

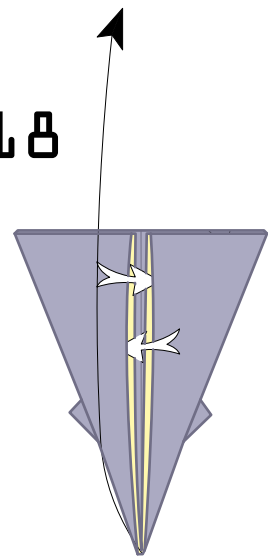

內部向外拉開

19

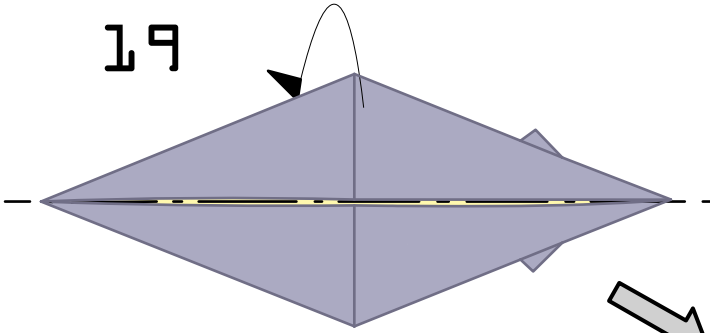

摺向後面

20

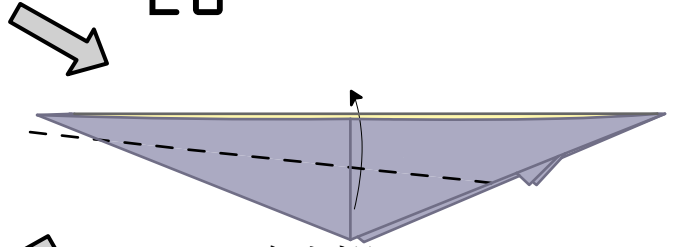

向上摺

21

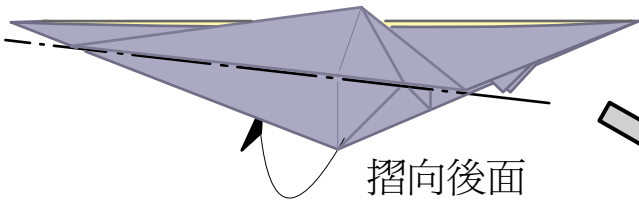

摺向後面

22

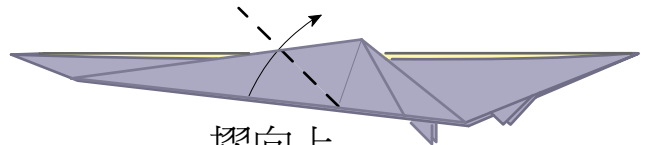

摺向上

23

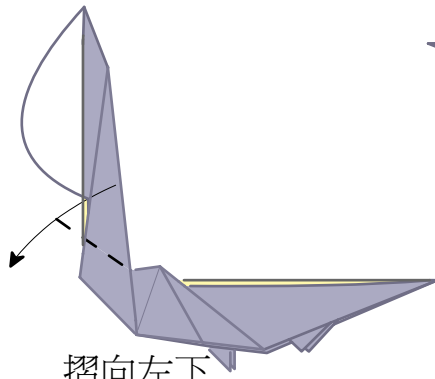

摺向左下

24

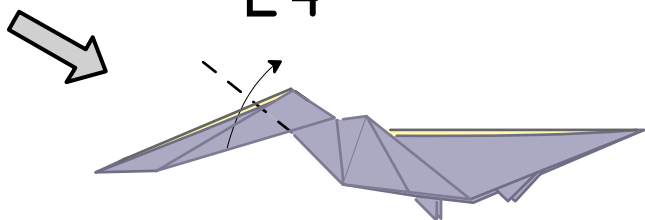

摺向上

25

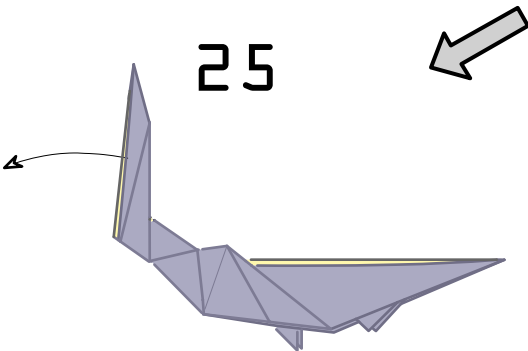

拉直

26

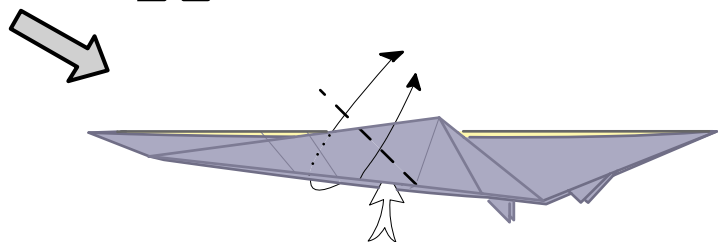

外翻摺

