

紙幣老鼠

創作：招叔

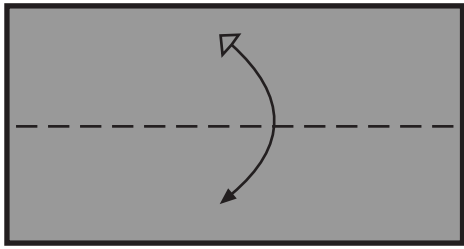

1. 對摺後打開



2. 摺完這步後翻轉

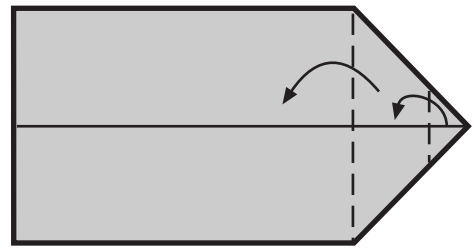
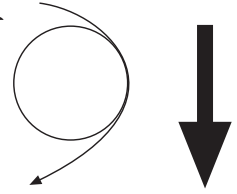

3. 先摺小角，後摺大角。

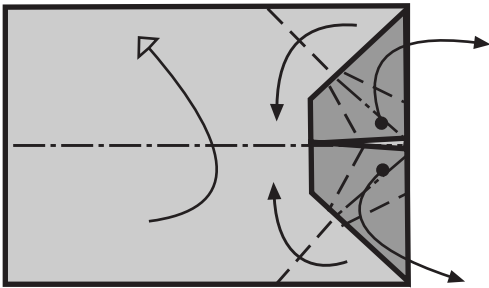

4. 對半摺向後，把藏於兩三角形內的耳朵拉出。

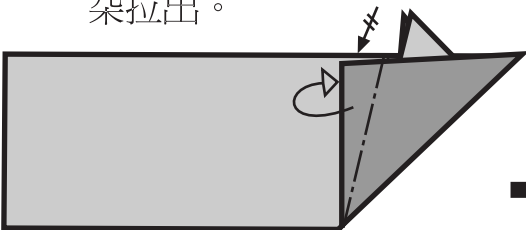
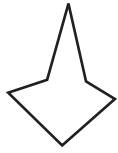

5. 把頭部多餘的紙摺向里面，做出一個自鎖結構，背面摺法相同。

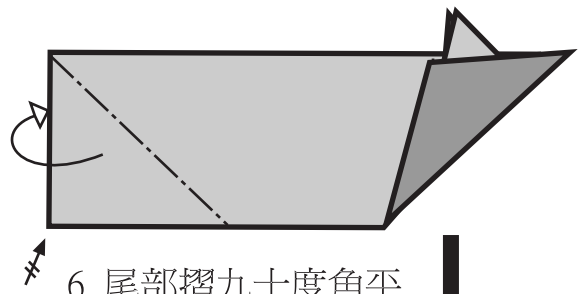

6. 尾部摺九十度角平分線，把三角形摺向中間，背面相同。

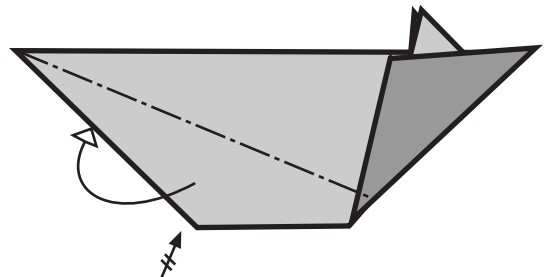

7. 尾部摺四十五度角的角平分線，把多餘的紙藏在中間，背面相同。

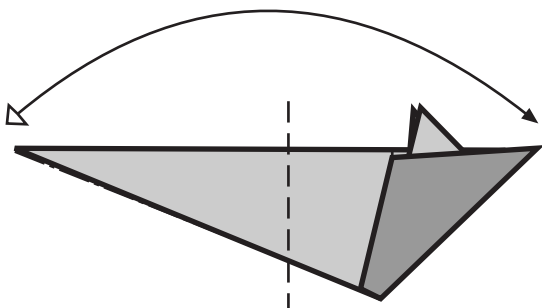

8. 兩角尖對齊，對摺後打開。



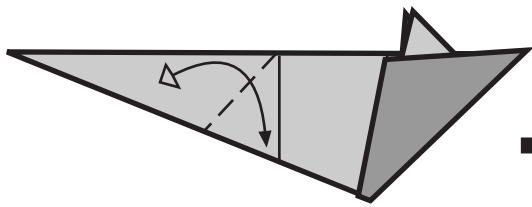

9. 摺九十度角的角平分線後打開

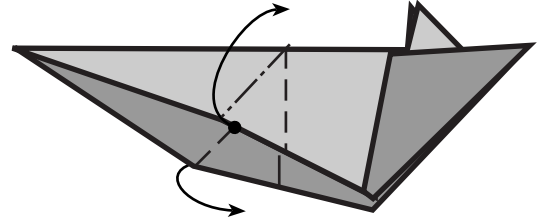

10. 把中間打開，按照山谷線摺好後壓平。

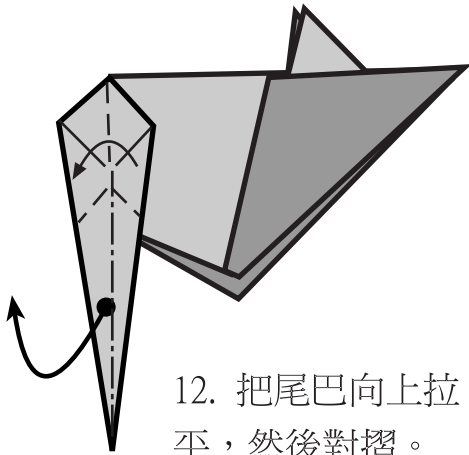

12. 把尾巴向上拉平，然後對摺。

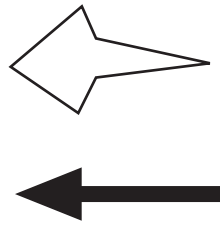

11. 邊線對齊中線對摺

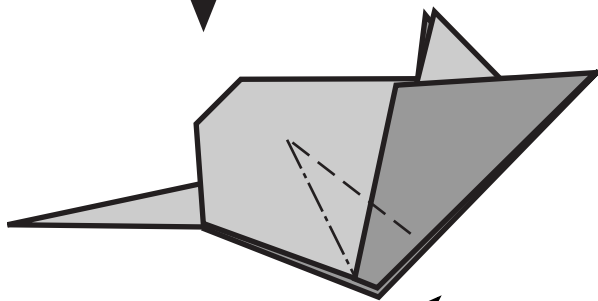

13. 按山谷線上下兩層向中間段摺做出腳



14. 把多餘的紙摺進里面，底層相同

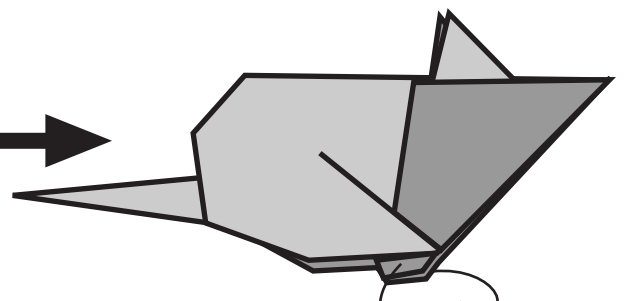

15. 打開兩只耳朵，然後整形。

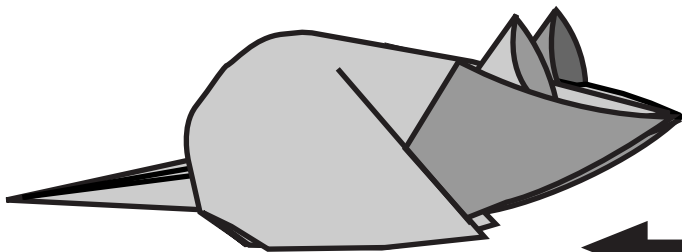

16. 完成