

Autor: J. Anibal Voyer

Dificultad:

Proporción: $h = \frac{1}{2} a$

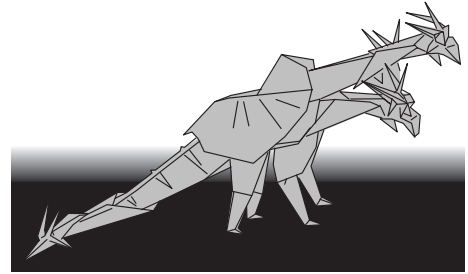

Dragón de 3 cabezas

1

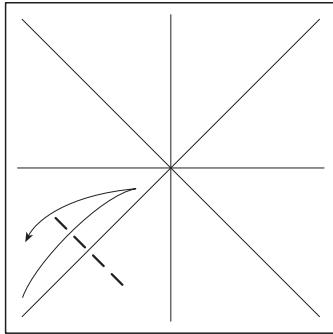

2

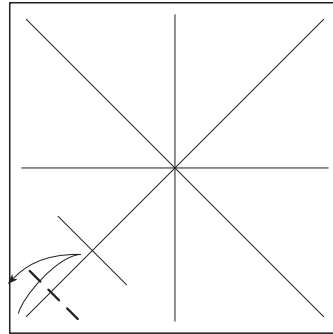

3

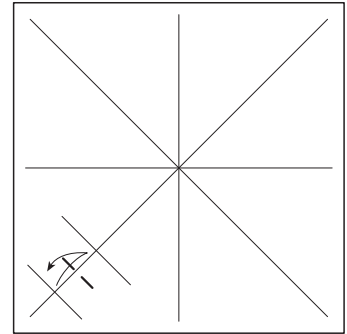

4

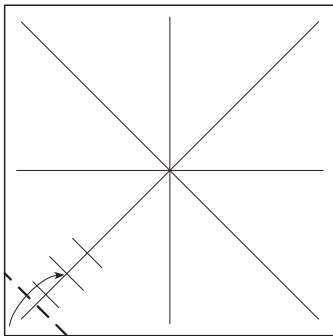

5 Repetir en las
otras 3 esquinas

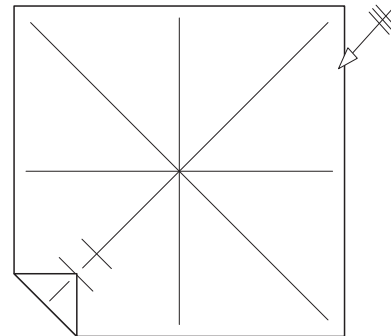

6

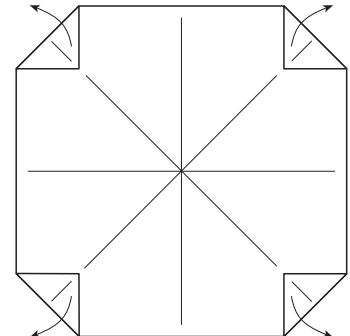

7

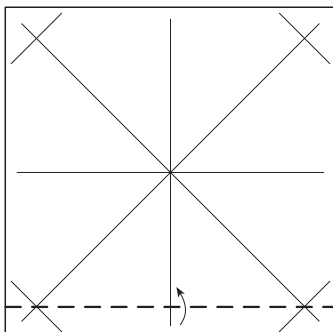

8

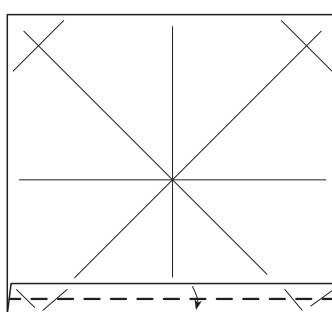

9

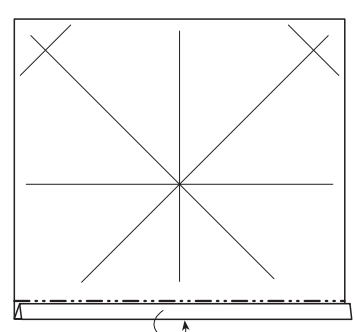

10

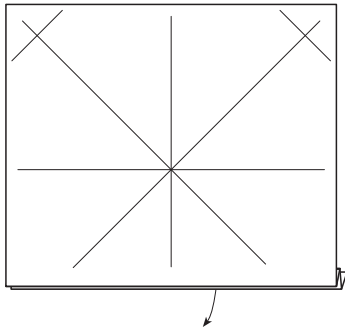

11 Repetir en los otros 3 lados

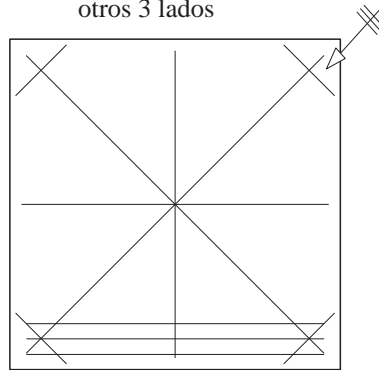

12

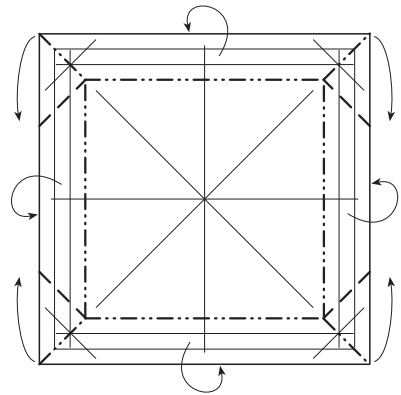

13

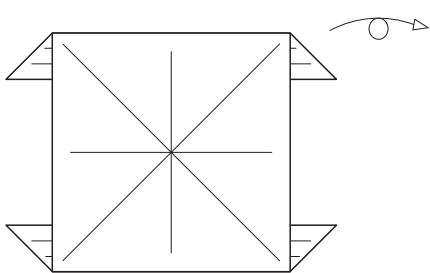

14

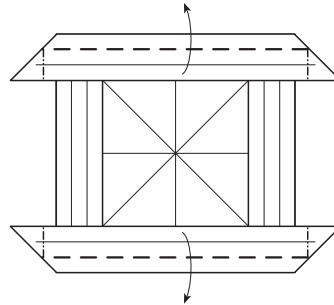

15

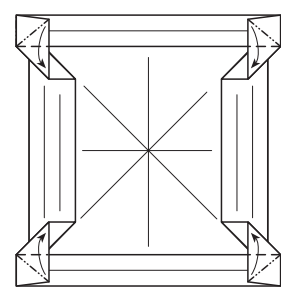

16

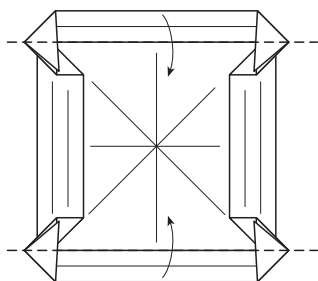

17

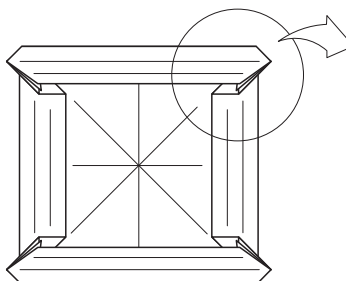

18 Hay que hacer estos pasos simultaneos en las 4 esquinas

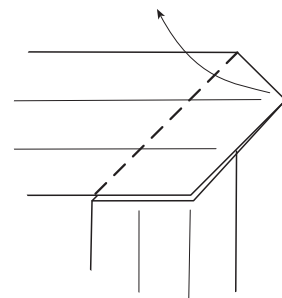

19

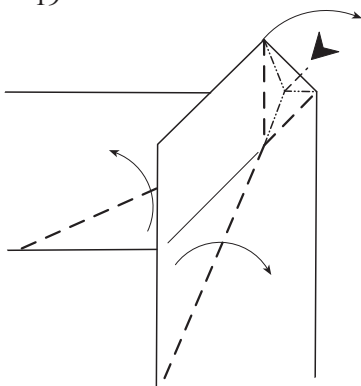

20

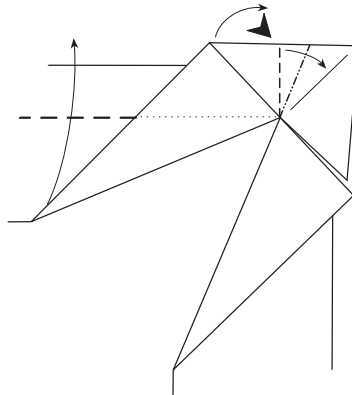

21

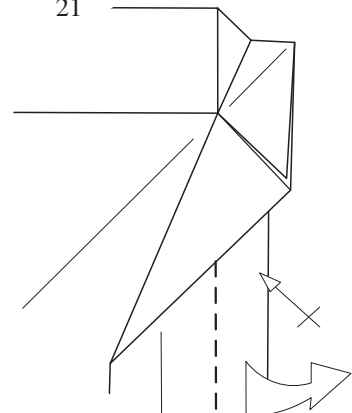

22

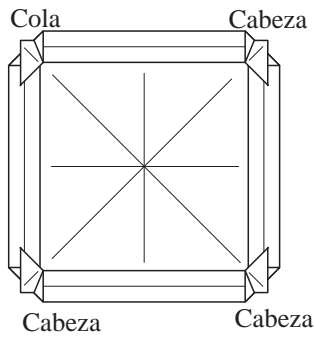

23 Plegado de las cabezas

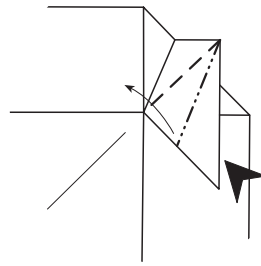

24

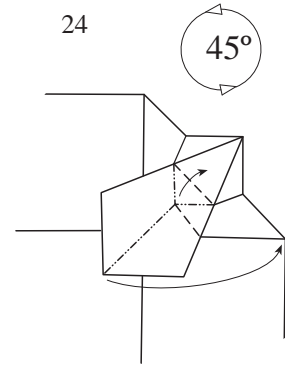

25

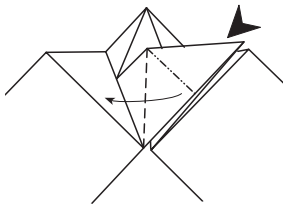

26

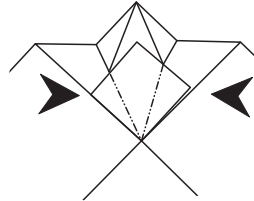

27

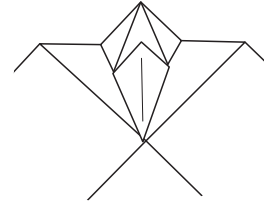

28 Plegado de la cola

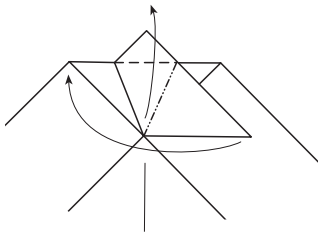

29

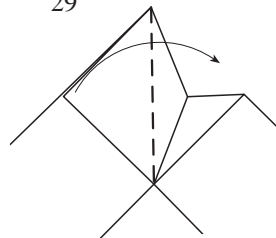

30

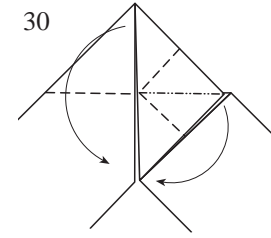

31

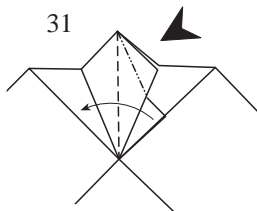

32

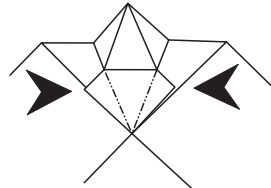

33 Hay que plegar a lo largo de todo el lado (se hace igual con las cabezas)

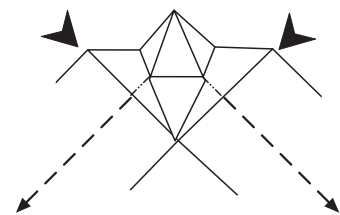

34 Repetir en las cabezas

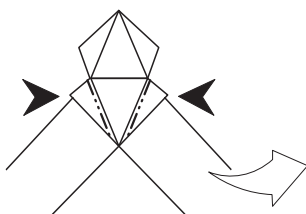

35 Solo se pliega en la cola

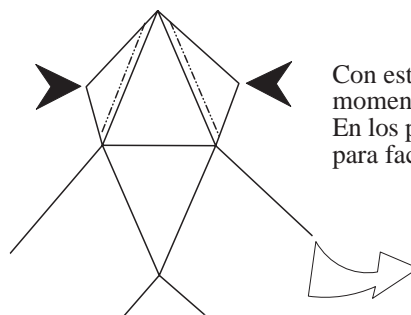

Con esto hemos terminado, por el momento, con las cabezas y la cola. En los proximos pasos no las dibujare para facilitar los dibujos.

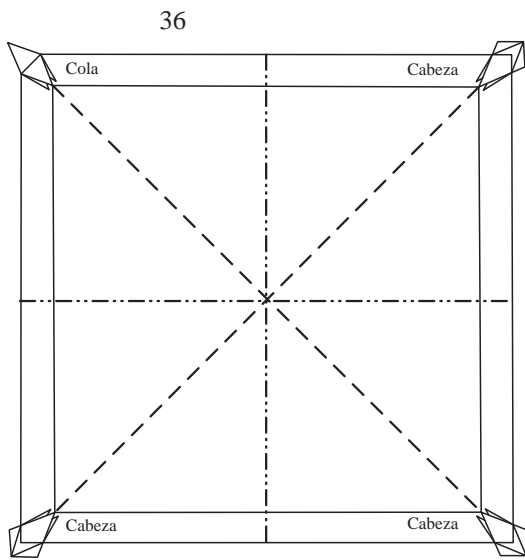

37 Las cabezas hacen que no se pueda doblar hasta la punta debe quedar como en el paso 39

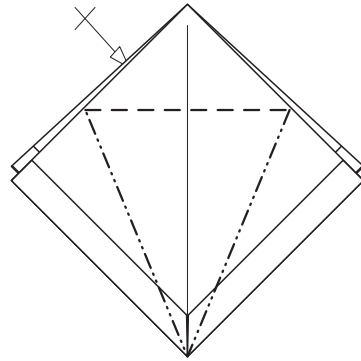

38 Cabeza vista desde dentro

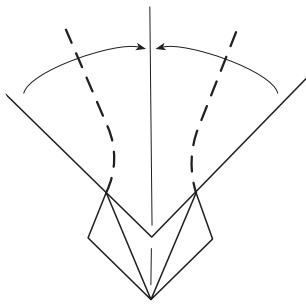

39

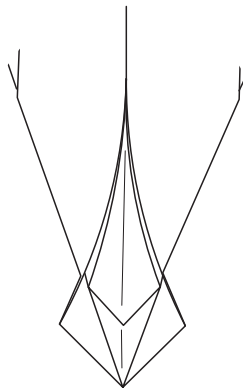

40

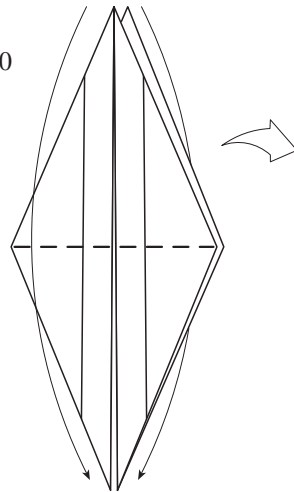

42 Desplegar hasta el paso 37

41

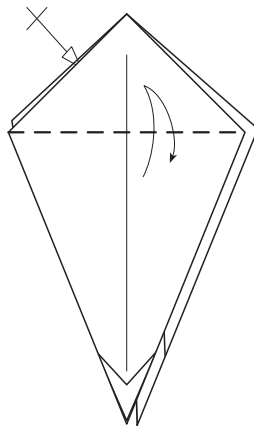
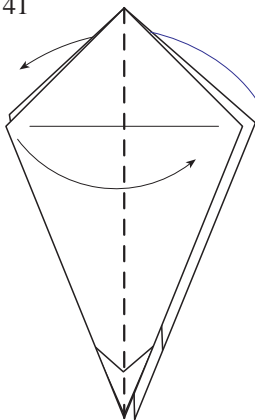

43

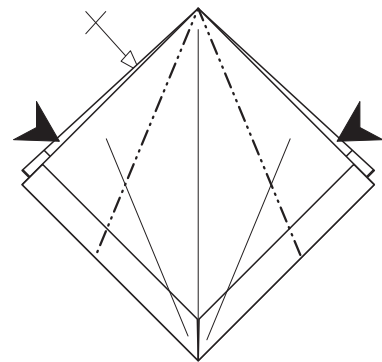

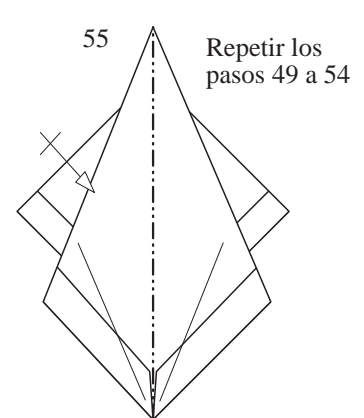
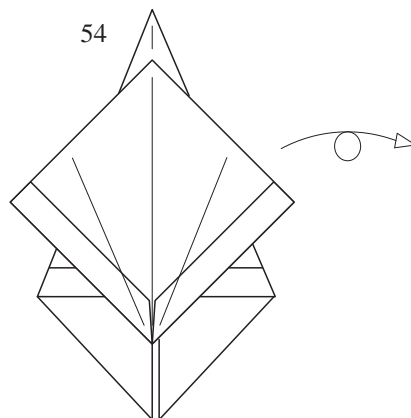
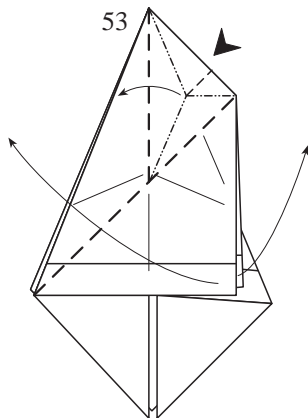
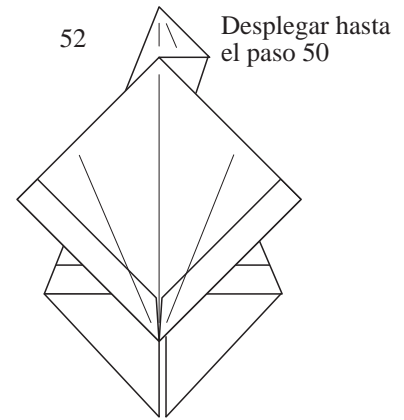
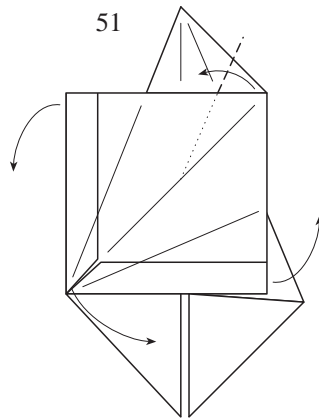
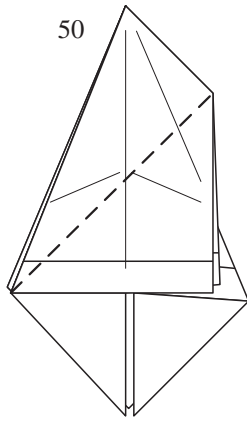
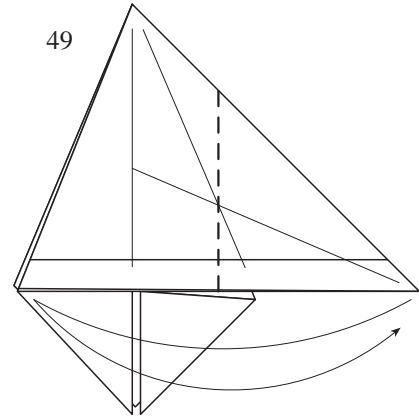
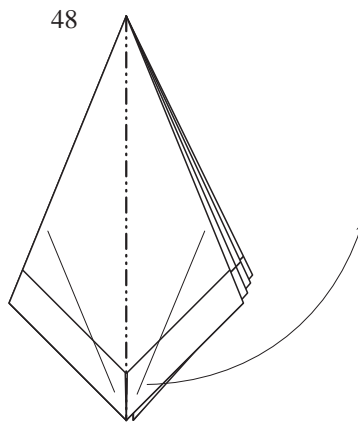
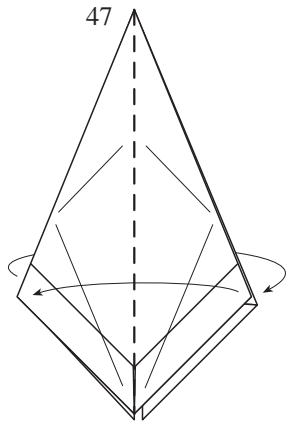
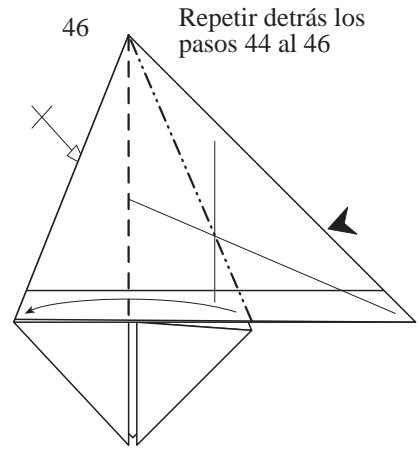
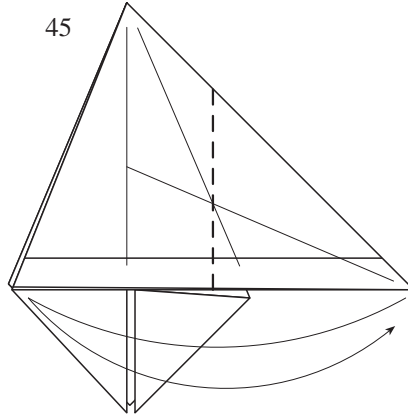
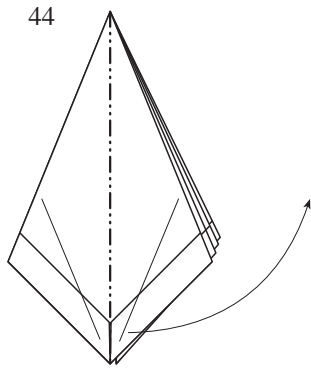

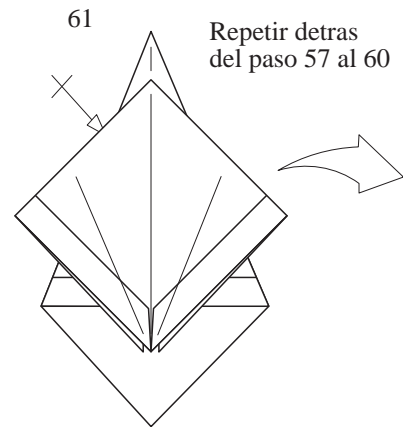
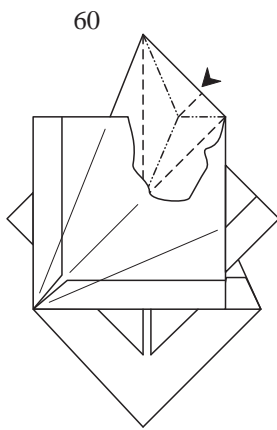
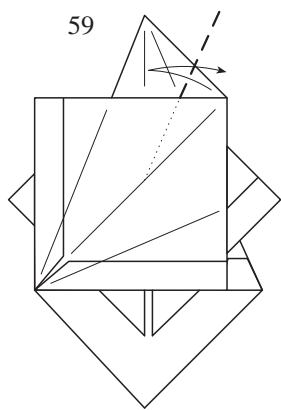
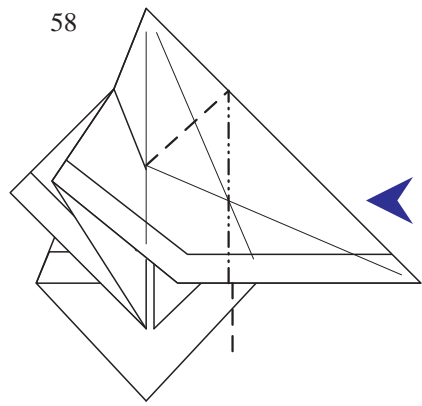
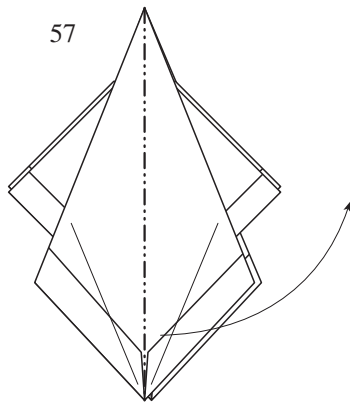
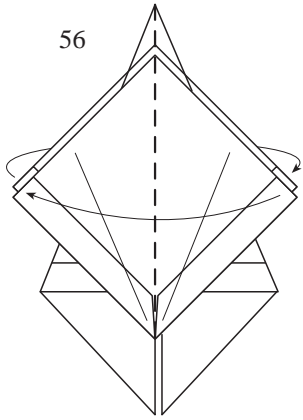

Repetir detras del paso 57 al 60

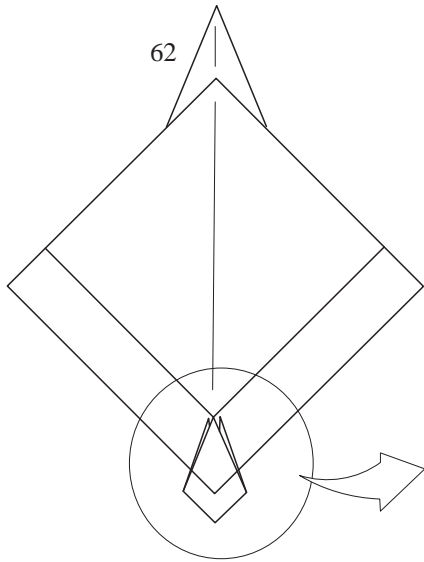

63 Continuemos con las cabezas

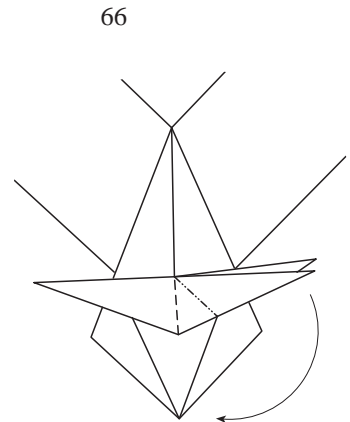
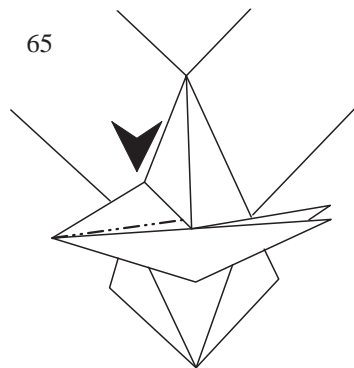
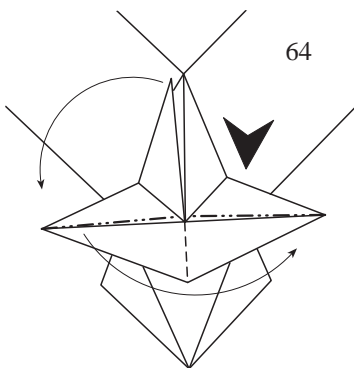
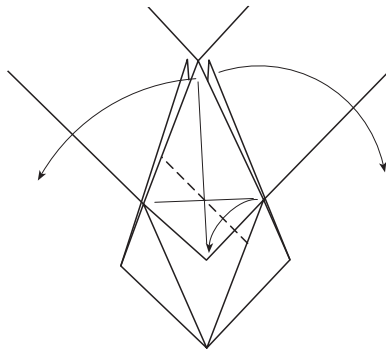

67

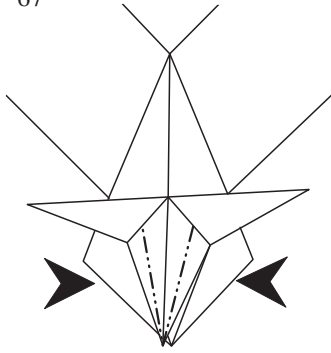

68 Los pasos 63 a 68 hay que repetirlos en las 3 cabezas

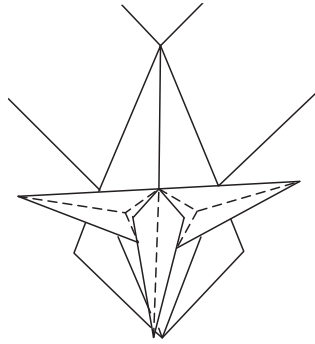

69 La Cola

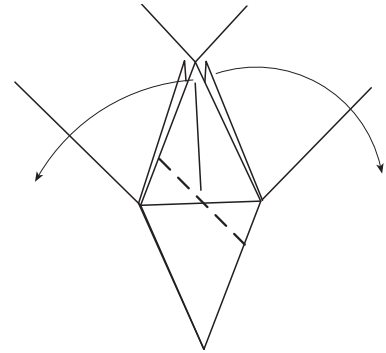

70

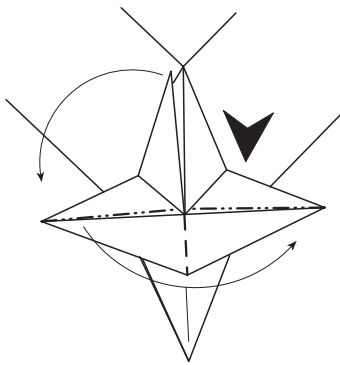

71

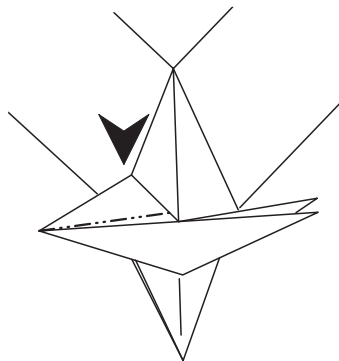

72

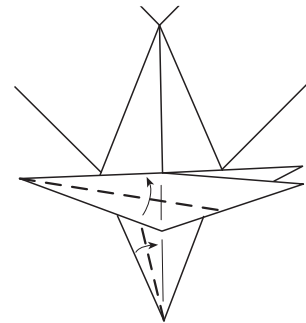

73

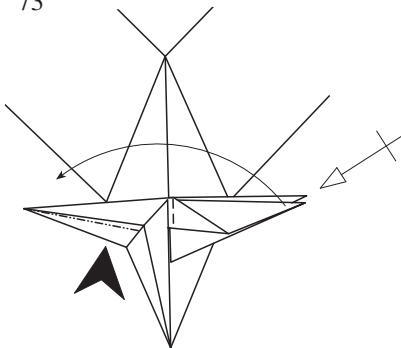

74

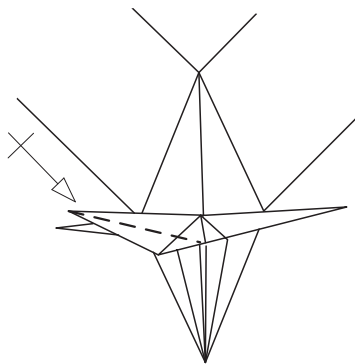

75

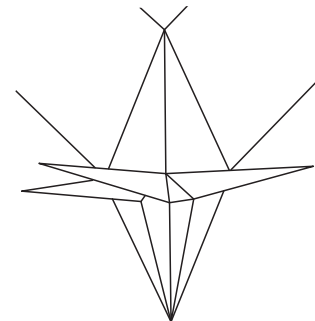

76 No dibujo las cabezas y la cola para simplificar los diagramas

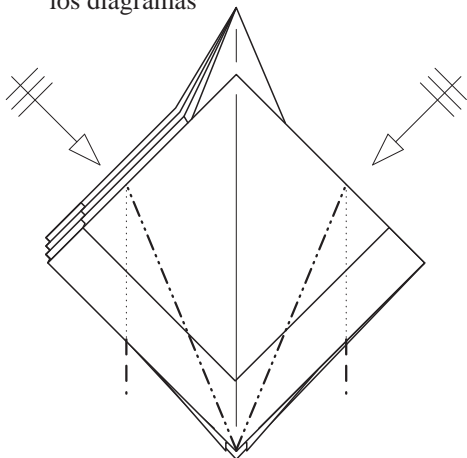

77

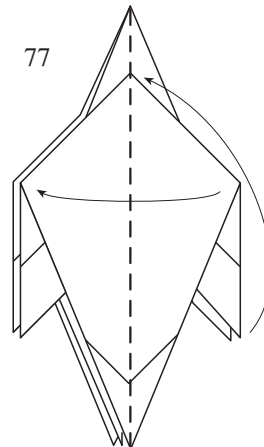

78

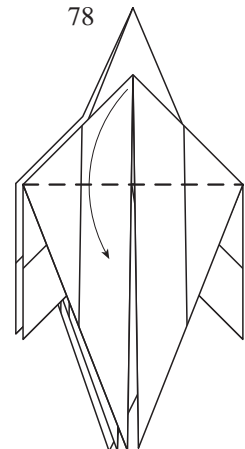

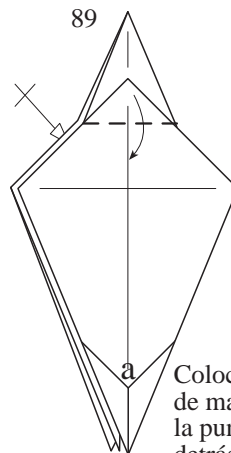
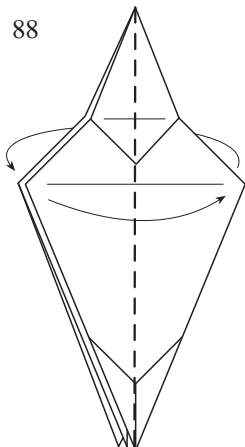
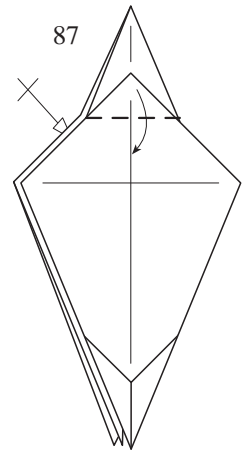
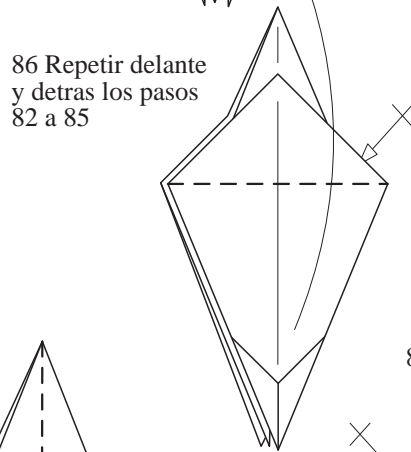
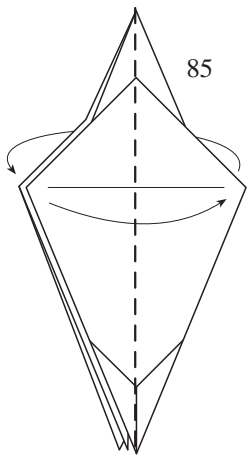
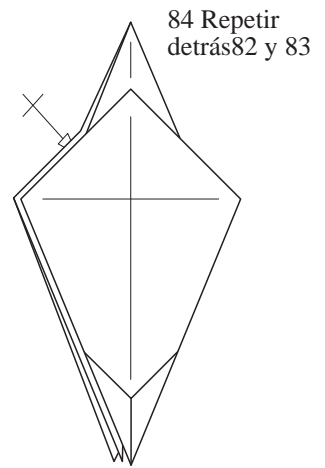
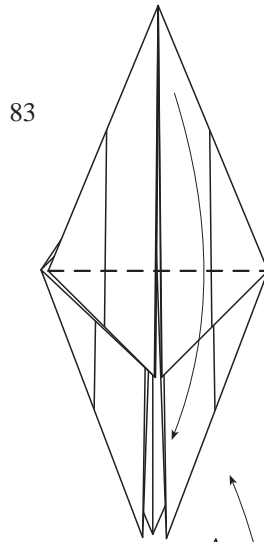
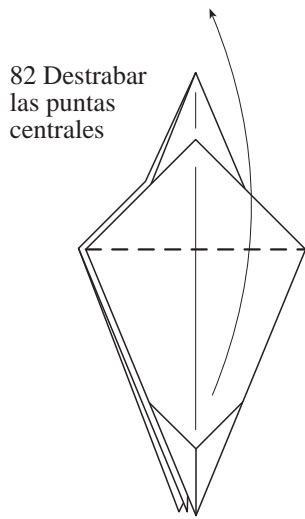
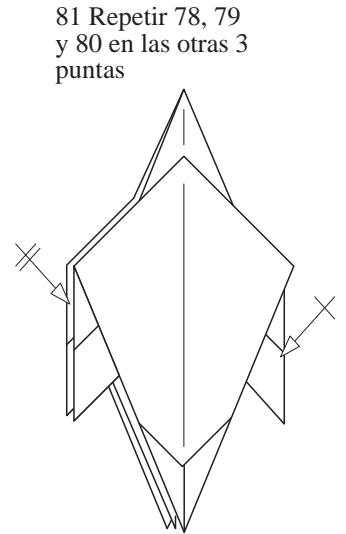
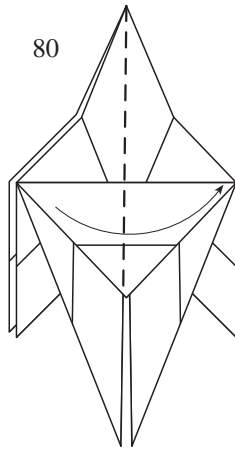
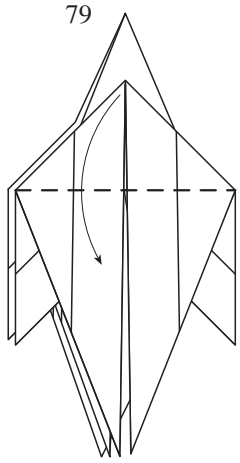

Colocar el modelo de manera que tanto la punta a como la de detrás sean cabezas

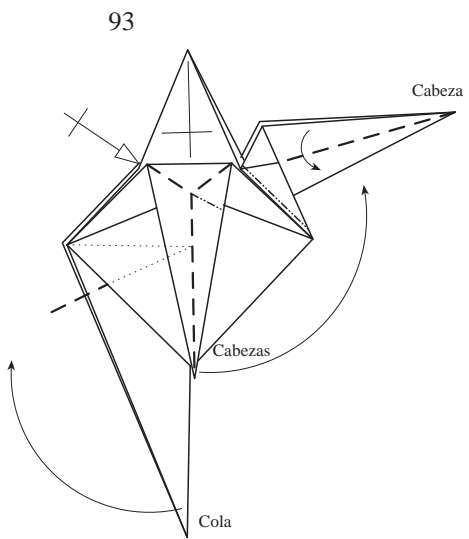
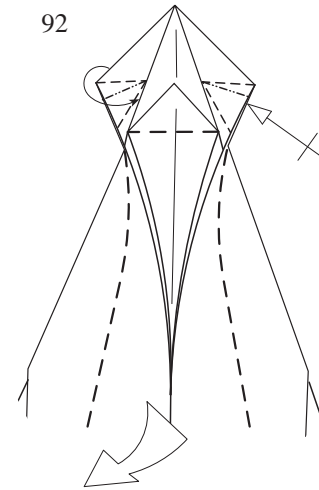
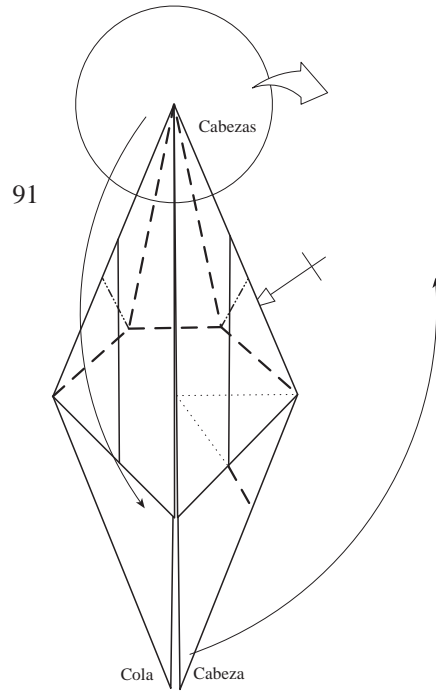
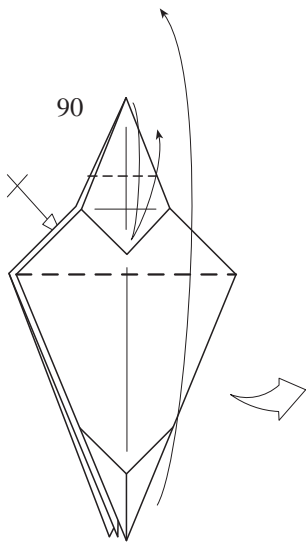

94 Detalle de las cabezas

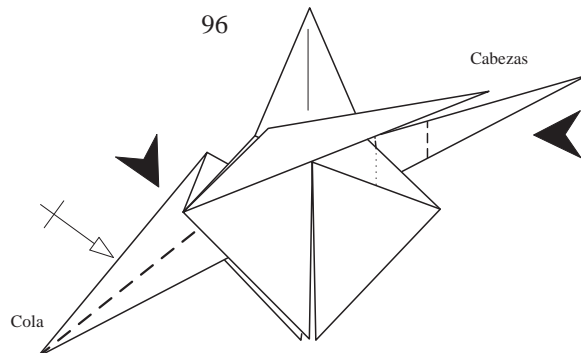
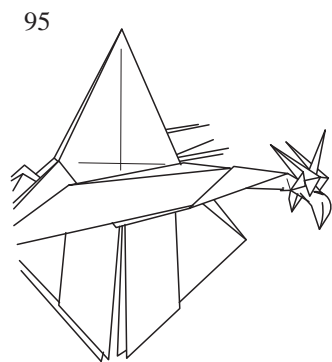
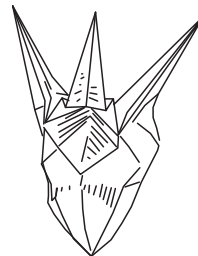

97 Detalle de la cola



98

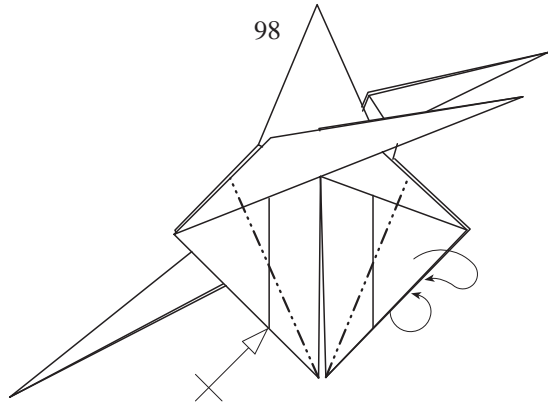

99

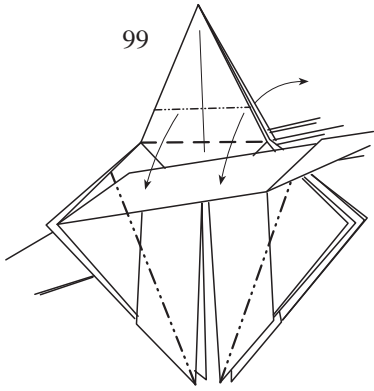

100

