

TRICERATOPS

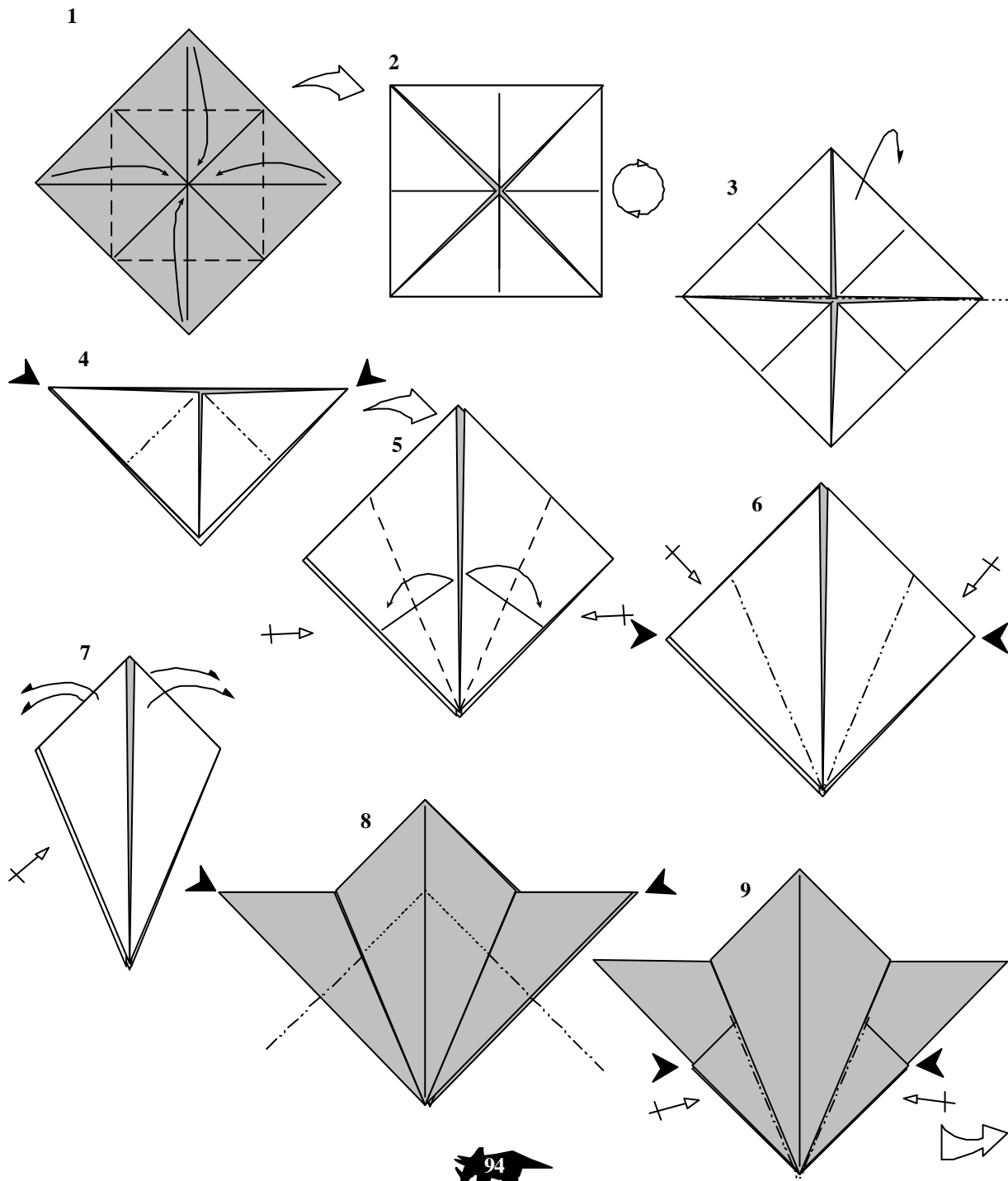

- NOMBRE: "Rostro con Tres Cuernos"
- SUBORDEN: Marginocéfalos
- PERIODO: Finales del Cretácico

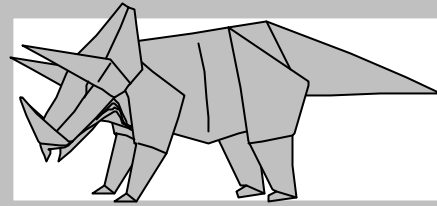

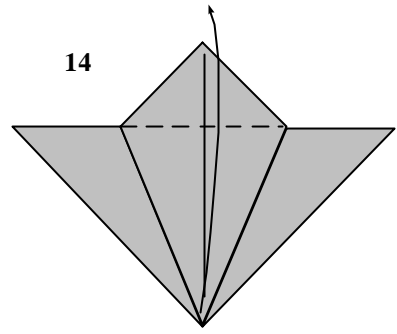
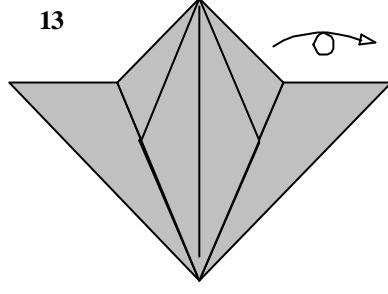
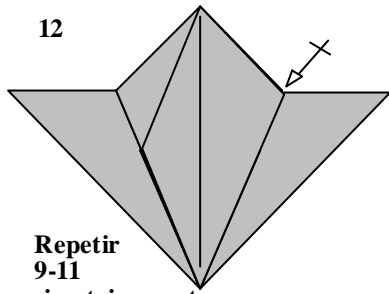
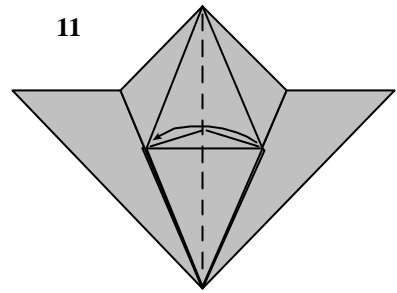
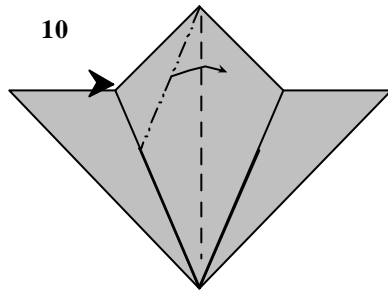
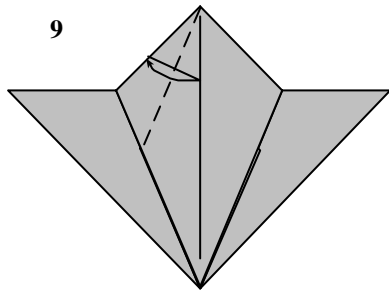

Repetir
9-11
simetricamente

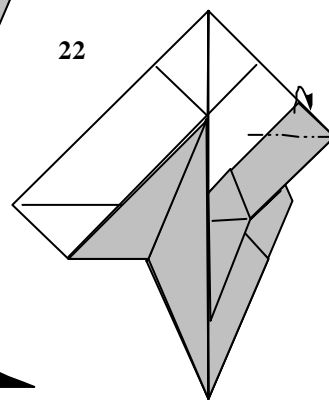
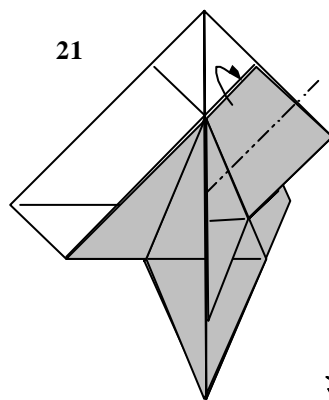
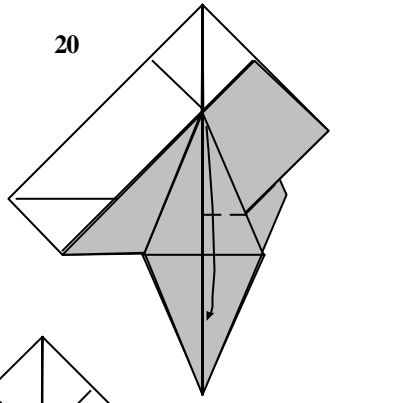
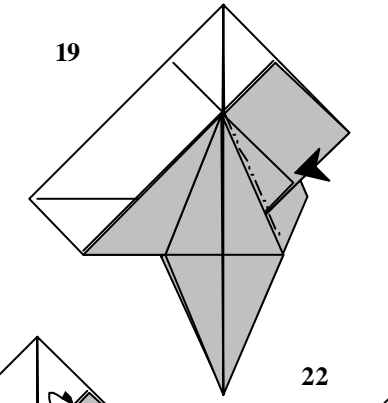
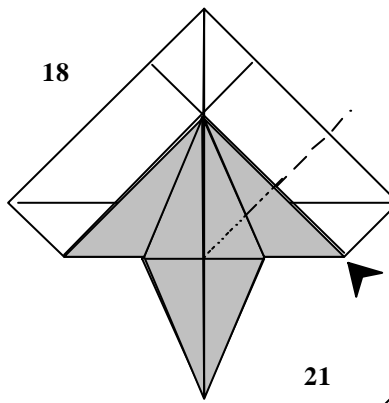
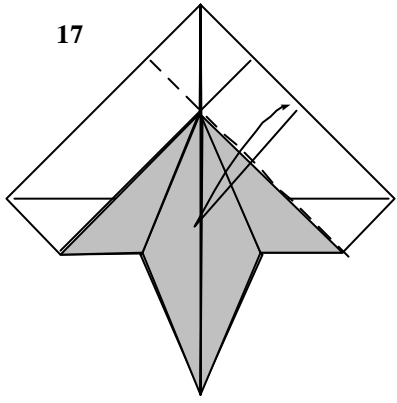
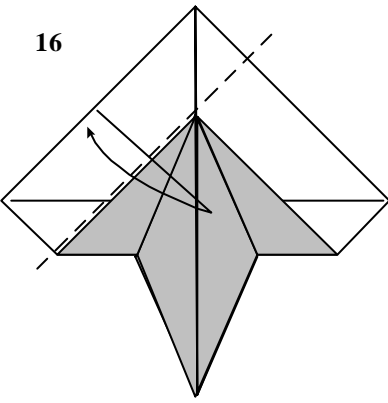
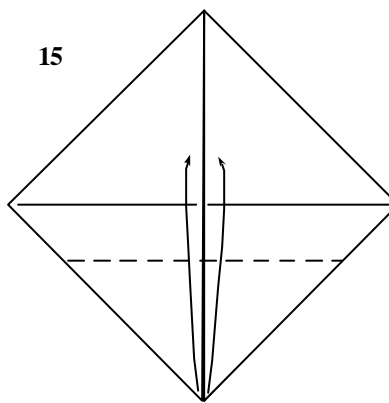

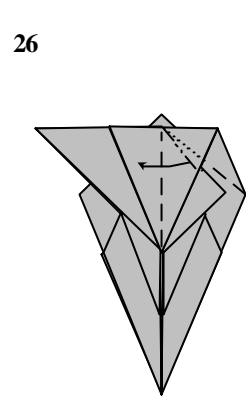
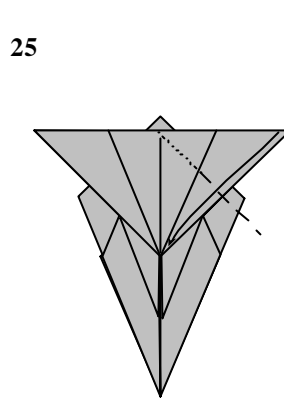
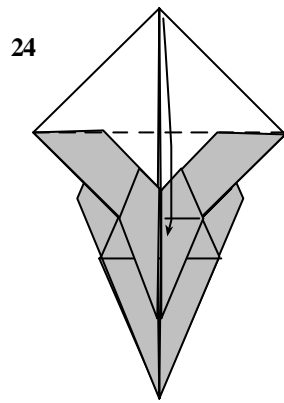
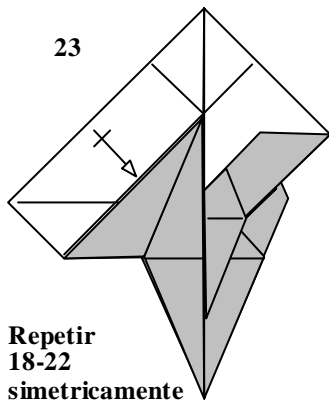

**Repetir
18-22
simetricamente**

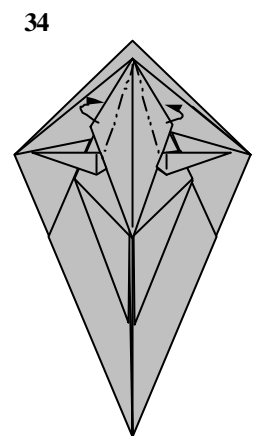
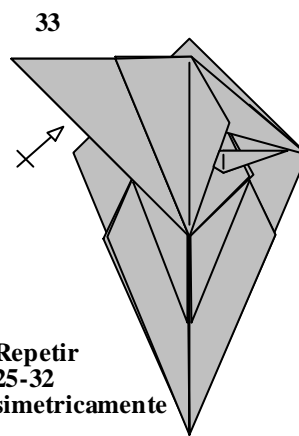
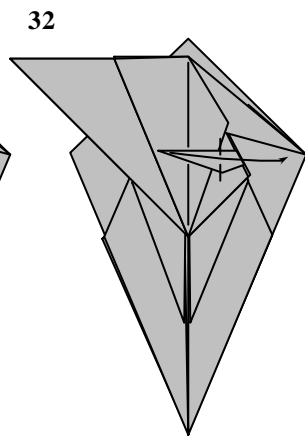
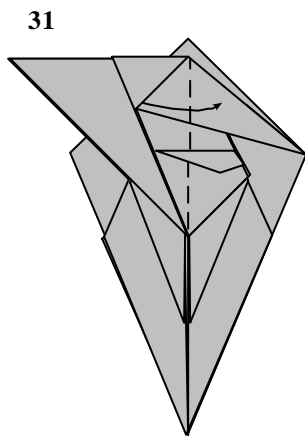
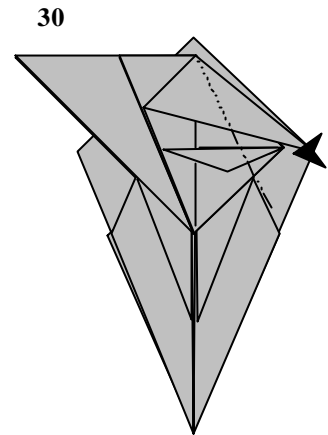
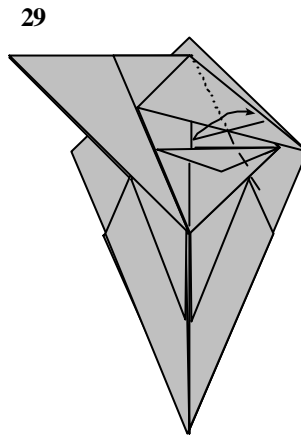
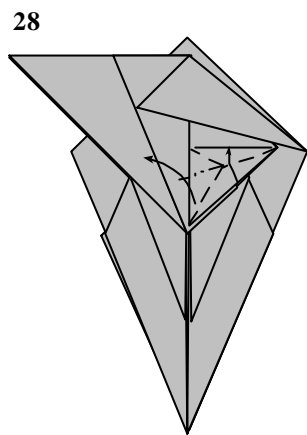
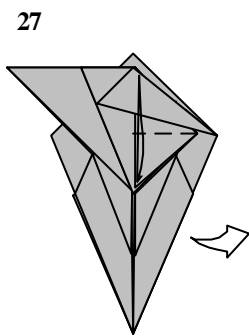

**Repetir
25-32
simetricamente**

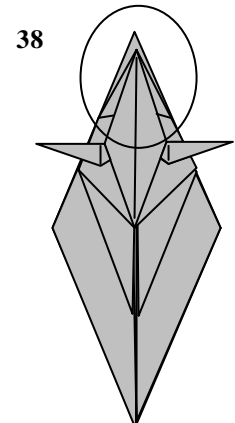
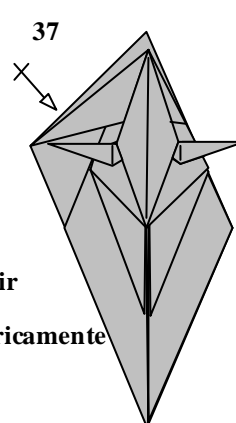
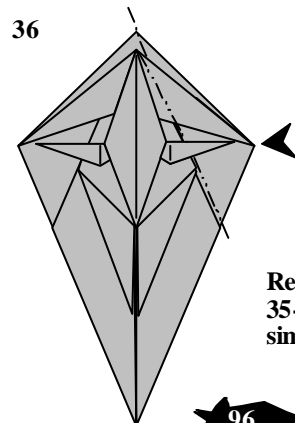
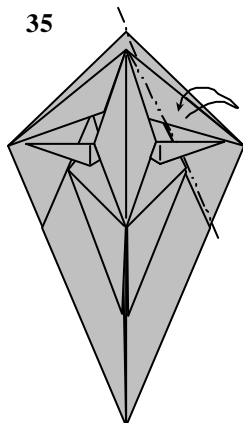

**Repetir
35-36
simetricamente**

