

① WHITE SIDE UP

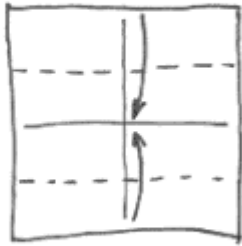

FOLD TO THE CENTRE

②

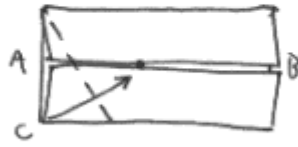

FOLD CORNER C UP
SO THAT IT LIES ON
LINE A-B

③

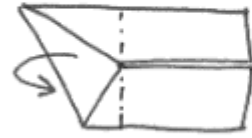

FOLD BEHIND

④

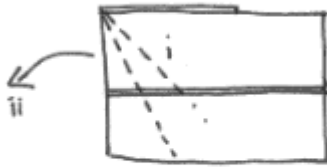

i PRECREASE AT 45°
AND 22.5° .
ii UNFOLD STEPS 2
AND 3

⑤

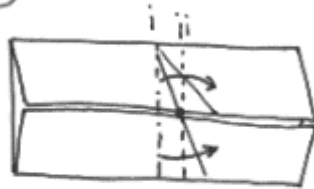

i RE FOLD STEP 3
ii FOLD WHERE THE CREASE
IN 4 PASSES THROUGH
THE CENTRE LINE

⑥

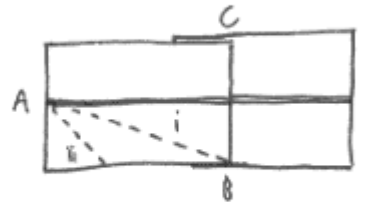

i PRECREASE ALONG A-B
ii PRECREASE AT 45°

⑦

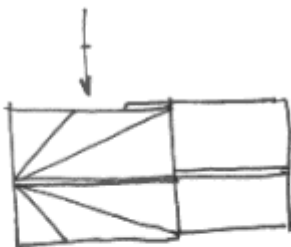

REPEAT ⑥ ON OTHER
SIDE. CREASE PATTERN
SHOWN.

⑧



REVERSE FOLD

⑨

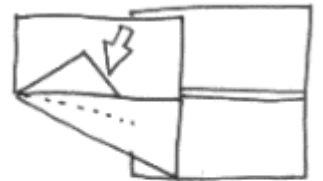

REVERSE FOLD OUT
ALONG CREASES ALREADY
MADE

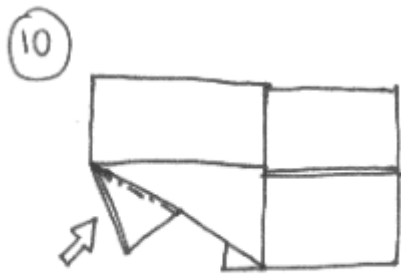

10 REVERSE FOLD

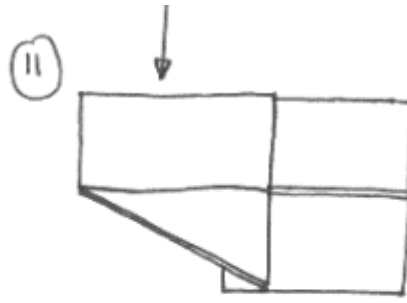

11 REVERSE 8-10 ON OTHER SIDE. TURN OVER

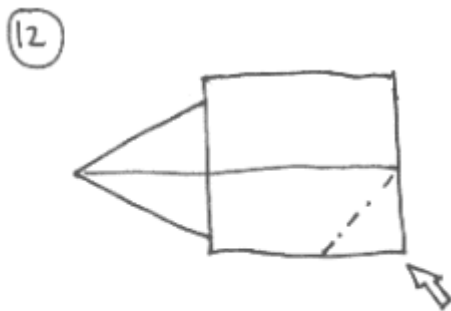

12 REVERSE FOLD

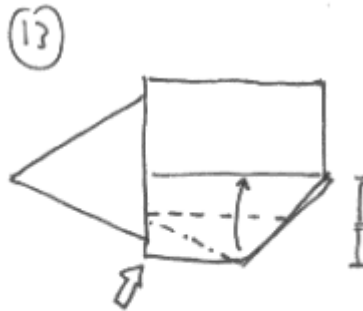

13 FOLD UPWARDS. SQUASH WHERE INDICATED

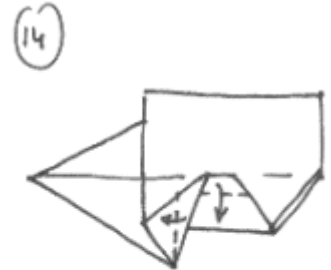

14 FOLD WHERE INDICATED TO THIN FRONT LEG.

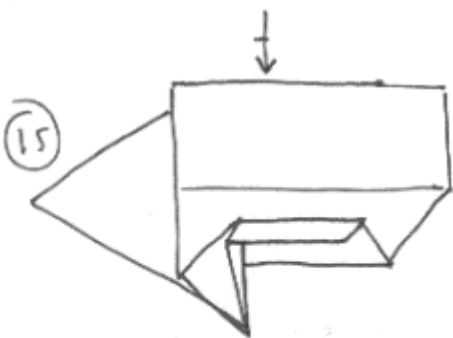

15 REPEAT ON OTHER SIDE

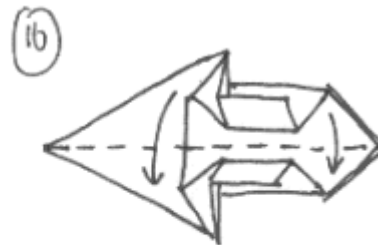

16 FOLD IN HALF

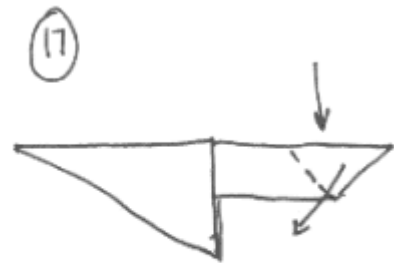

17 FOLD LEG DOWN. REPEAT ON OTHER SIDE.

18

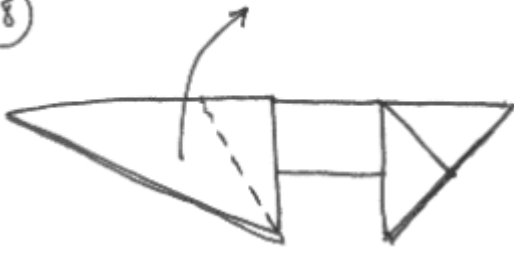

OUTSIDE REVERSE FOLD

19

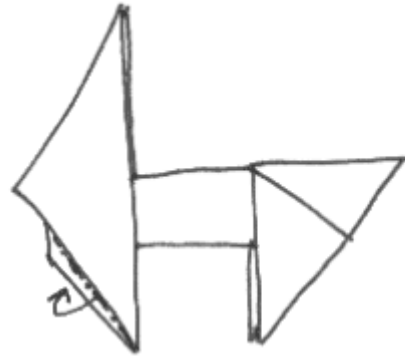

NARROW FRONT LEGS

ANIMAL BASE

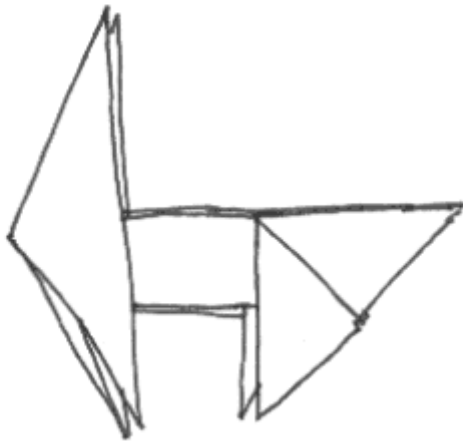

THIS BASE HAS FOUR LEGS,
 A FLAP FOR A TAIL, A LONG
 NECK AND TWO LONG FLAPS INSIDE
 THE HEAD FOR HORNS OR
 EARS.

①

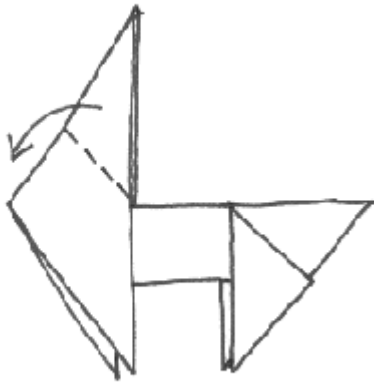

START WITH ANIMAL BASE 1.
OUTSIDE REVERSE FOLD HEAD

②

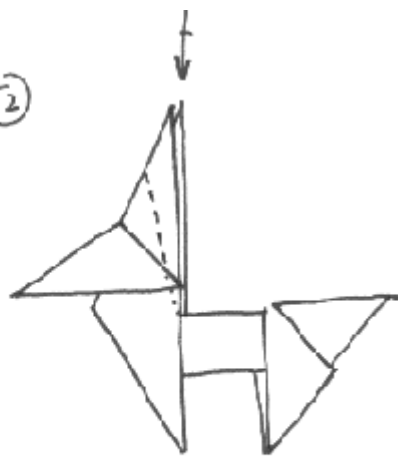

FORM EARS

③



REVERSE AND TAIL

④



REVERSE FOLD
TAIL OUT

⑤ (OPTIONAL)



FOLD OVER TO
TURN TAIL WHITE

⑥



REVERSE FOLD TO
FORM FRONT LEGS

⑦

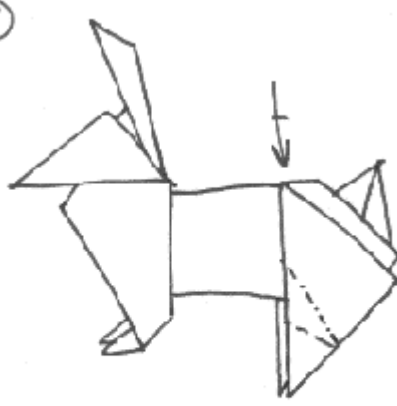

SHAPE THE REAR LEGS
WITH A MOUNTAIN &
VALLEY FOLD

⑧

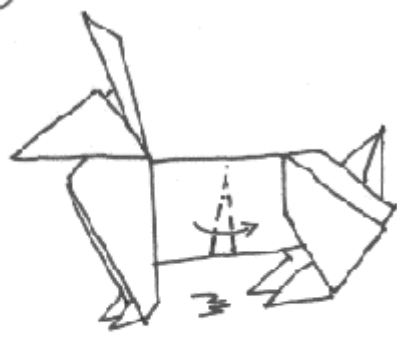

SHAPE BODY WITH
A CRUMP

⑨



SHAPE EARS

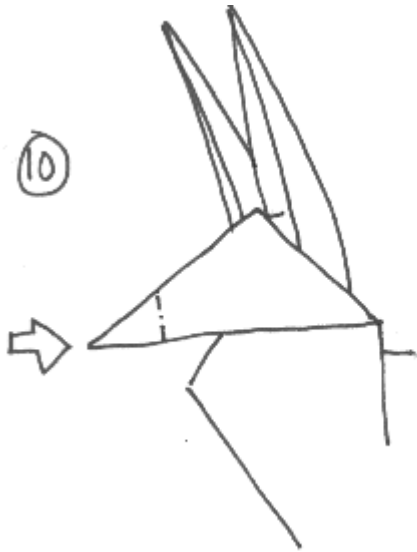

REVERSE FOLD

11



SHAPE FACE.
AN OPTIONAL SINK
CAN BE USED TO
SHAPE THE CHEST

FINISHED HARE

