

Esqueleto Simple del Tirannosaurus Rex

Francisco Javier Caboblanco Brasero

Dibujos del autor

CABEZA

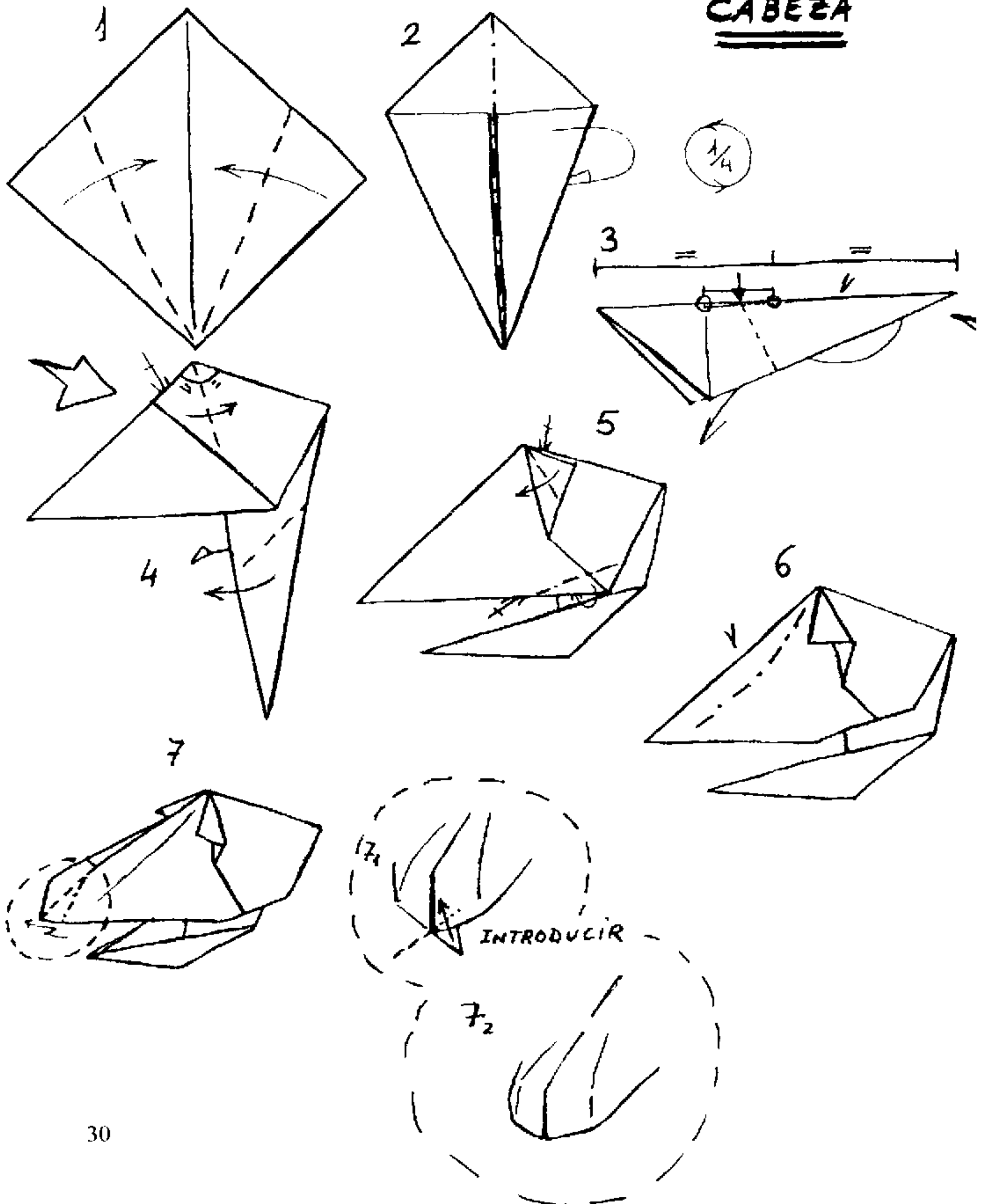

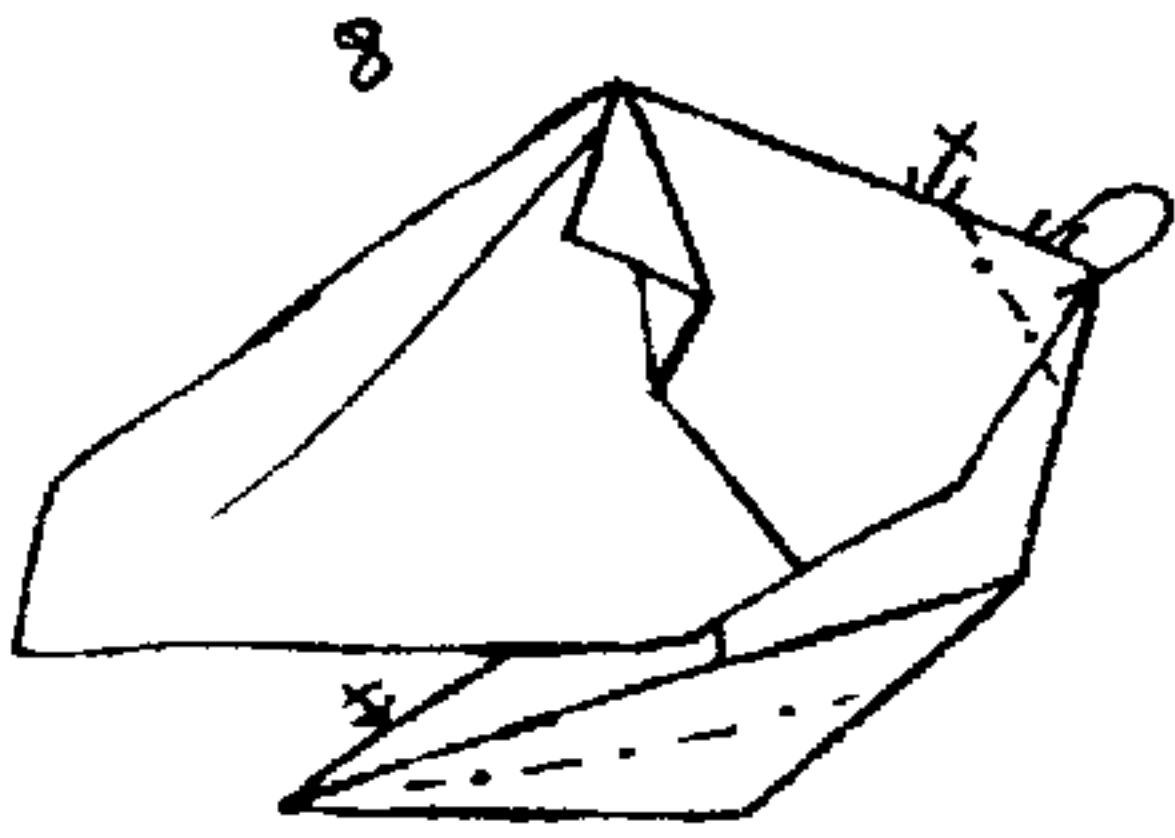

9

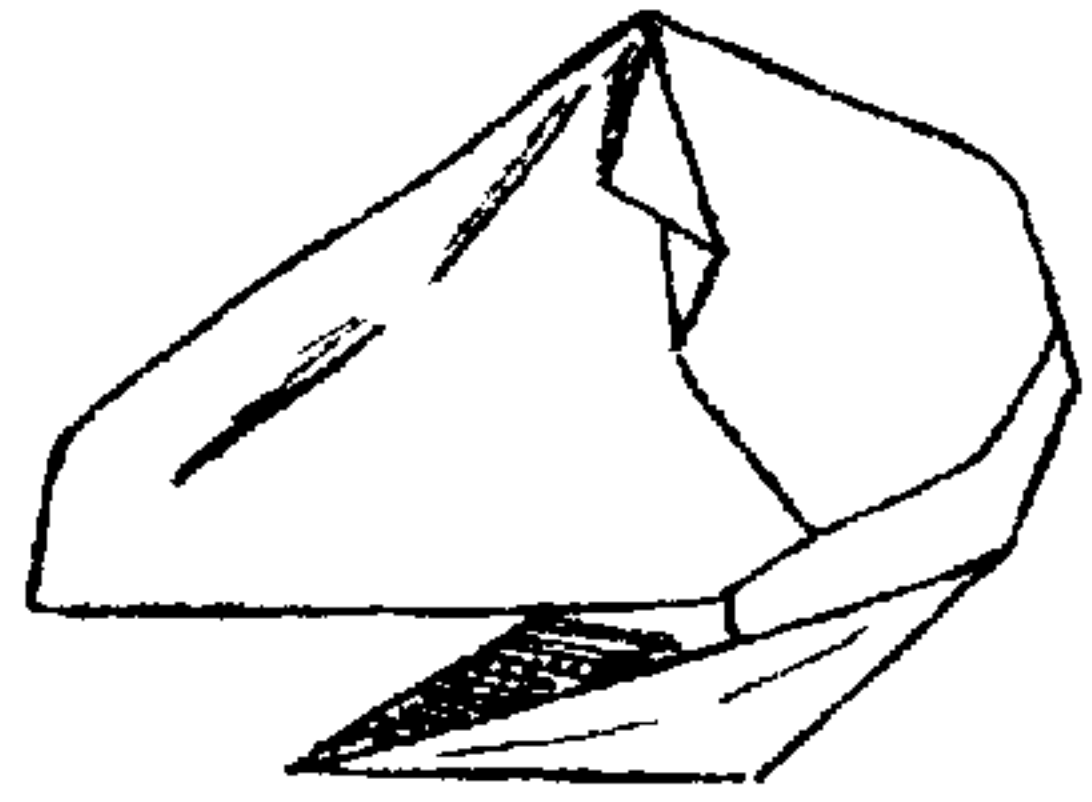

CUELLO

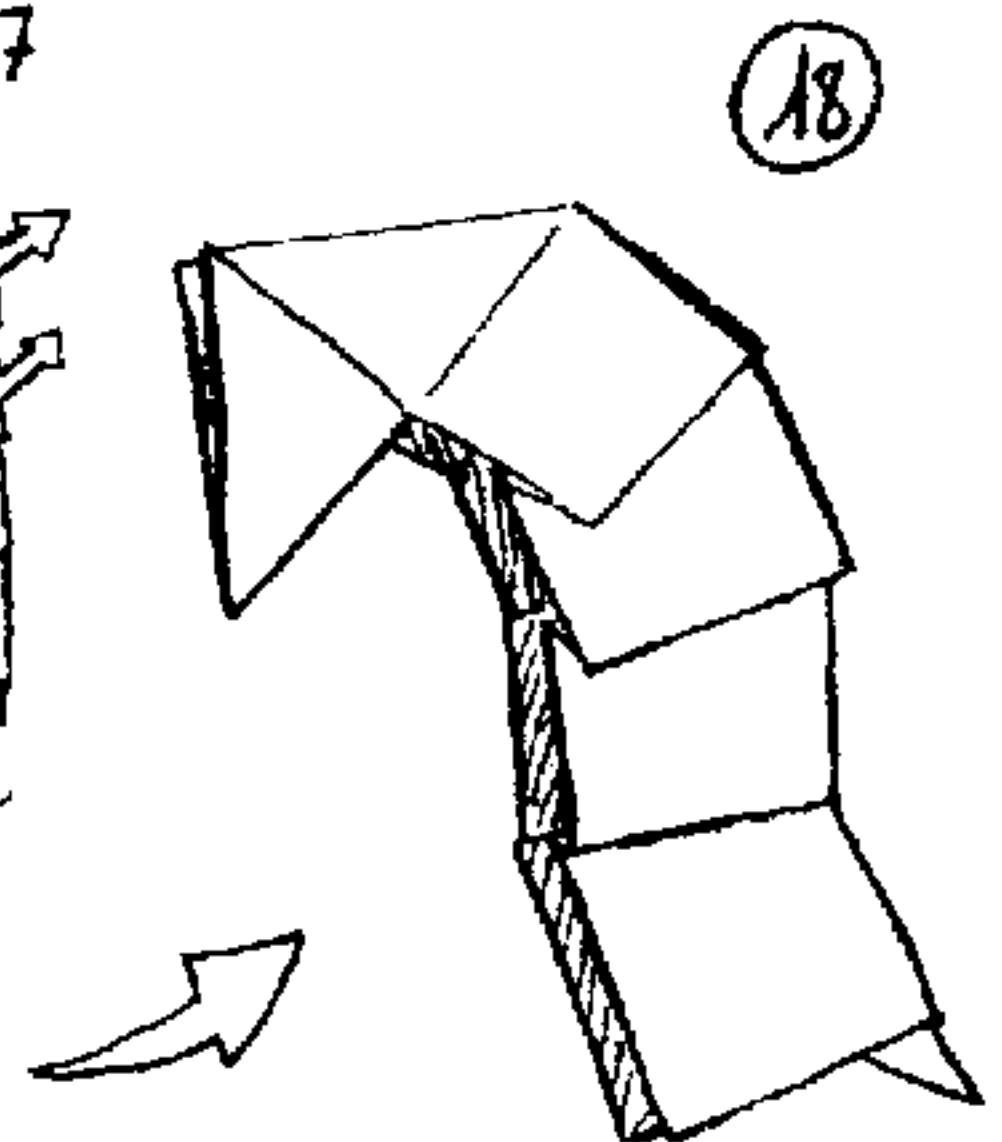
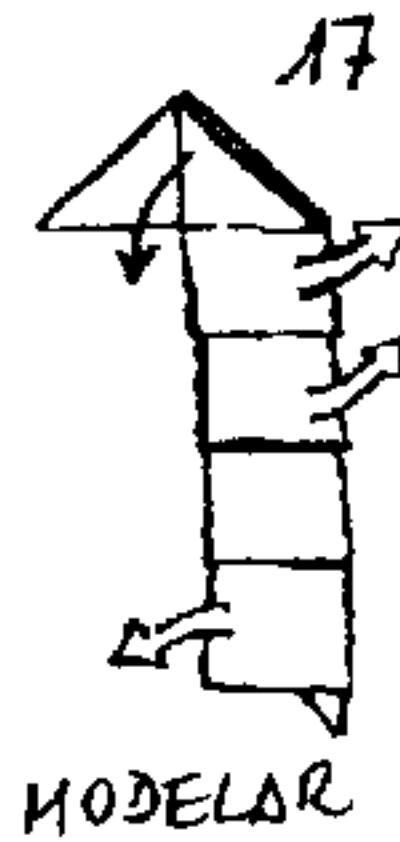
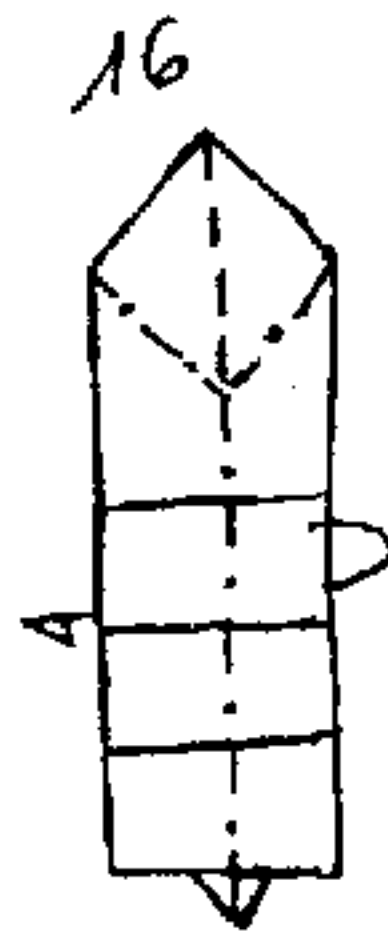
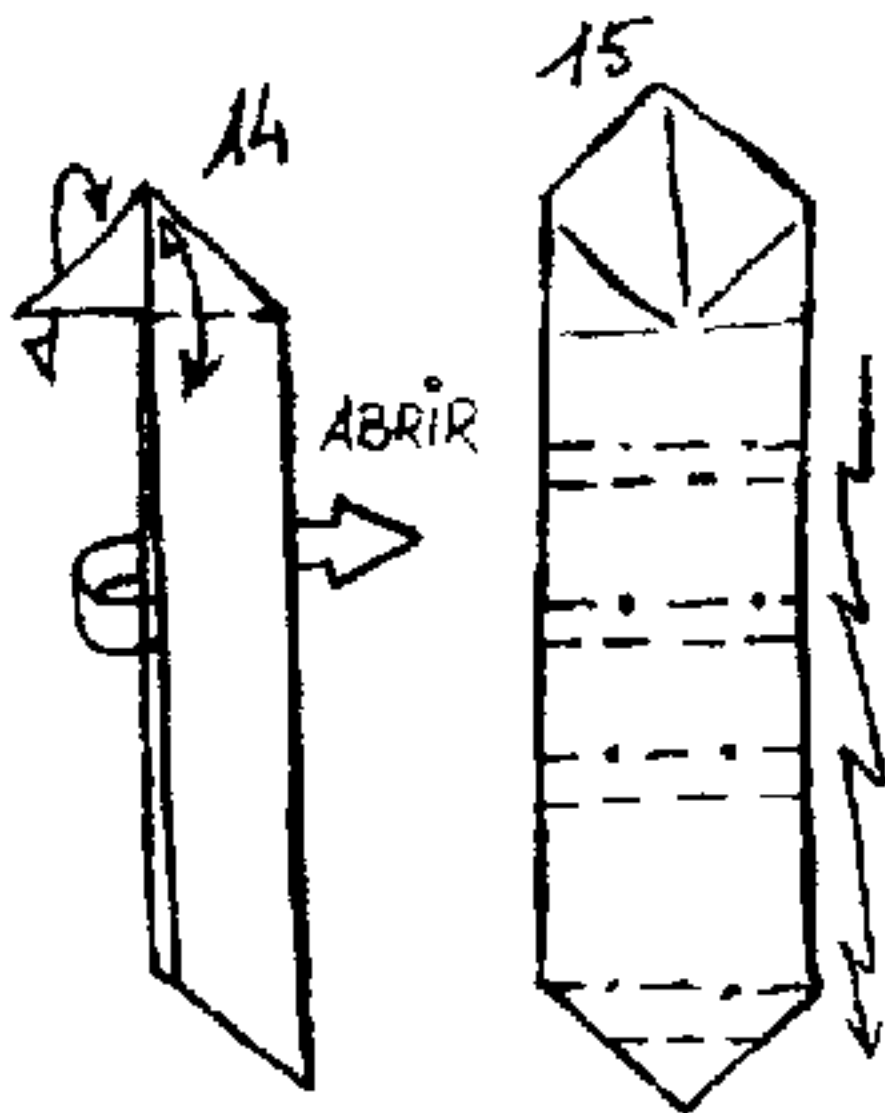
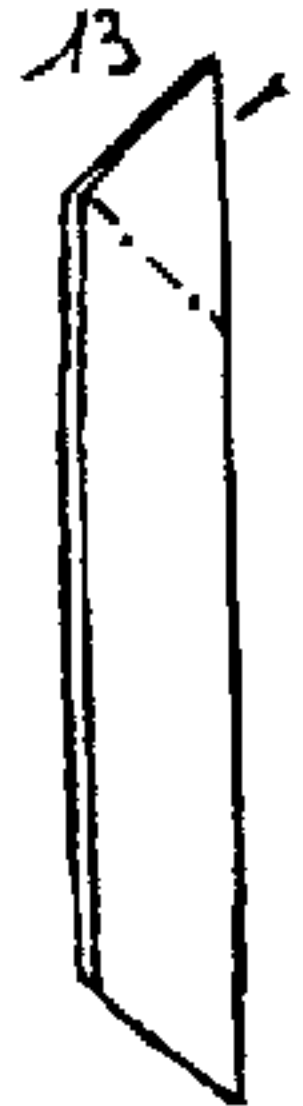
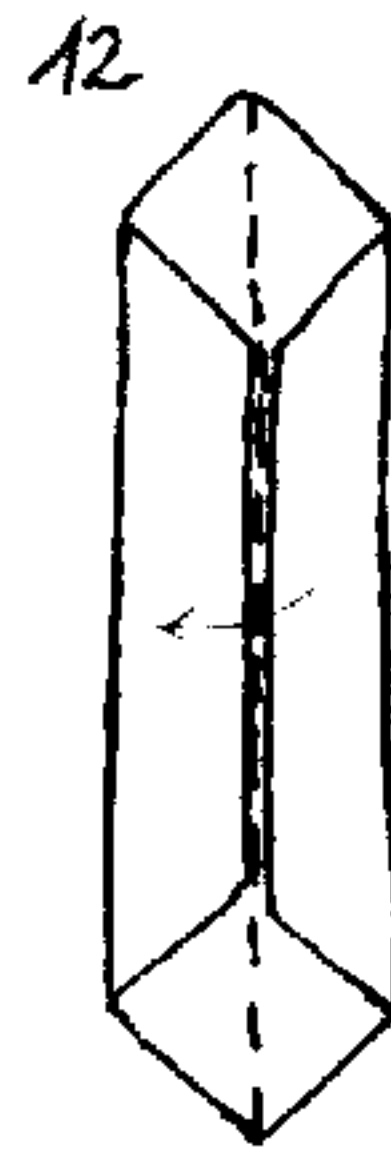
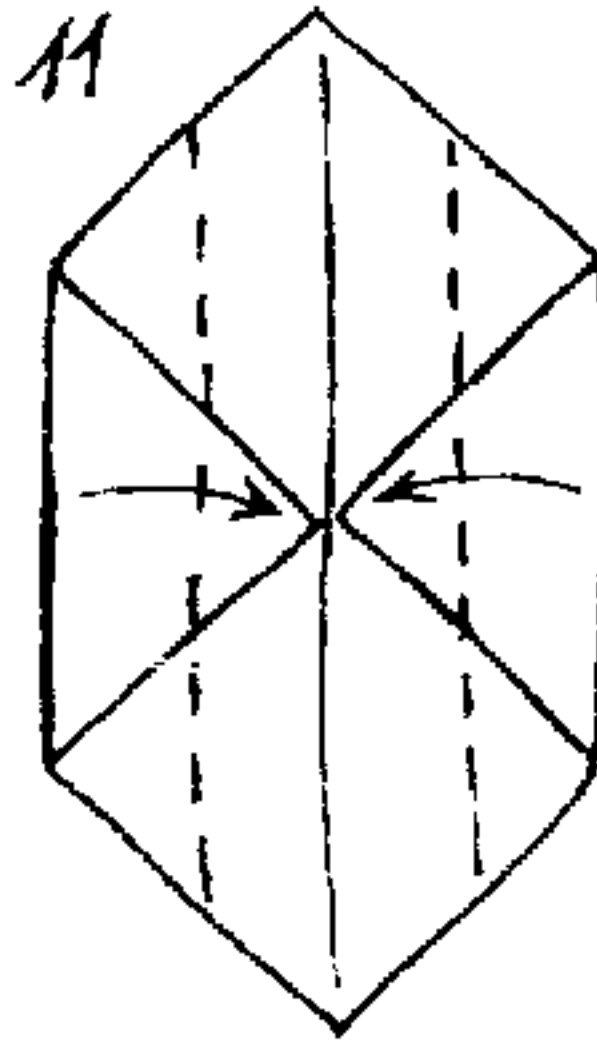
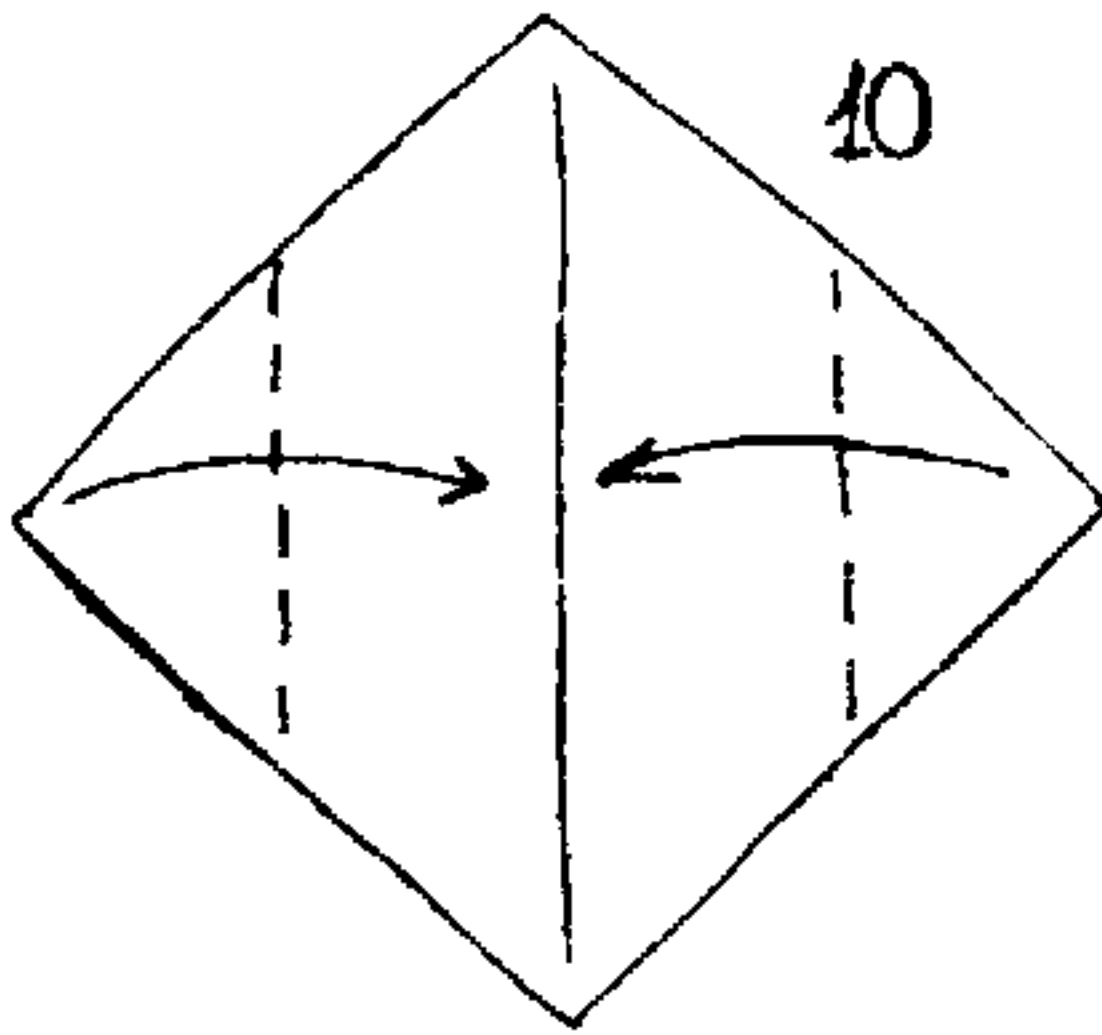

OMÓPLATOS (Y BRAZOS)

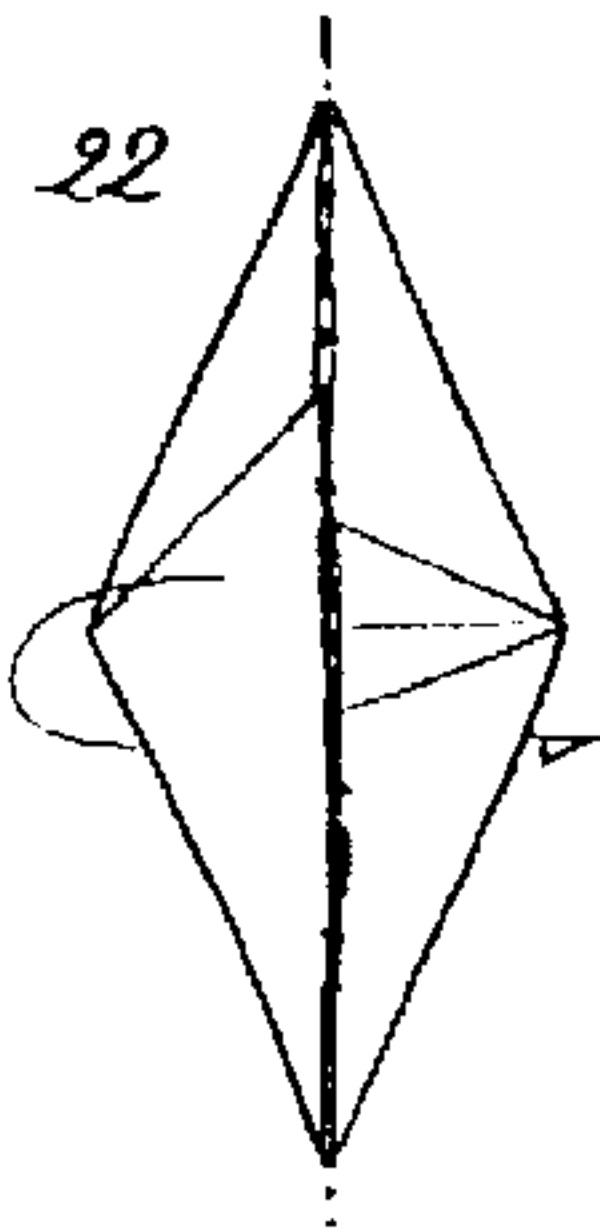
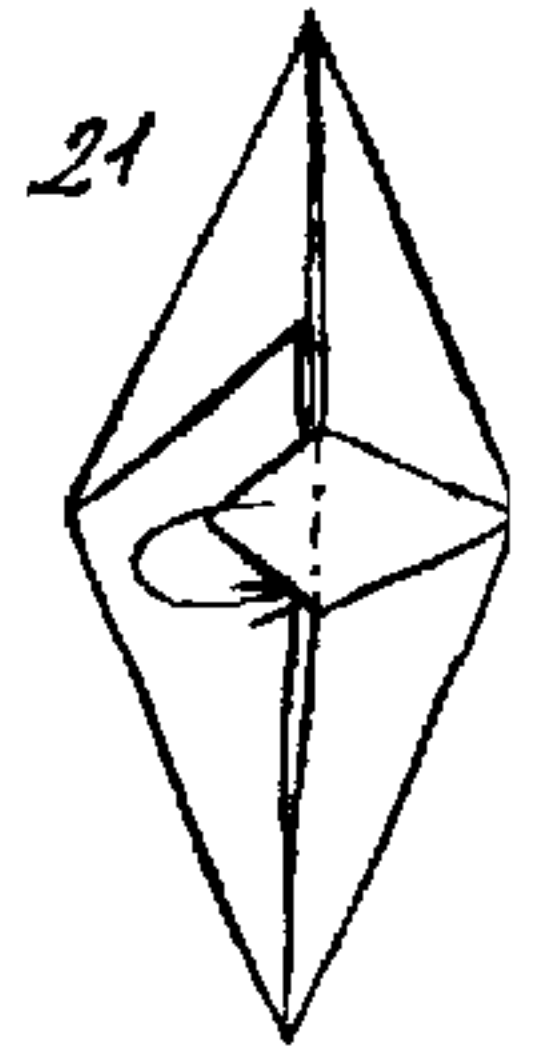
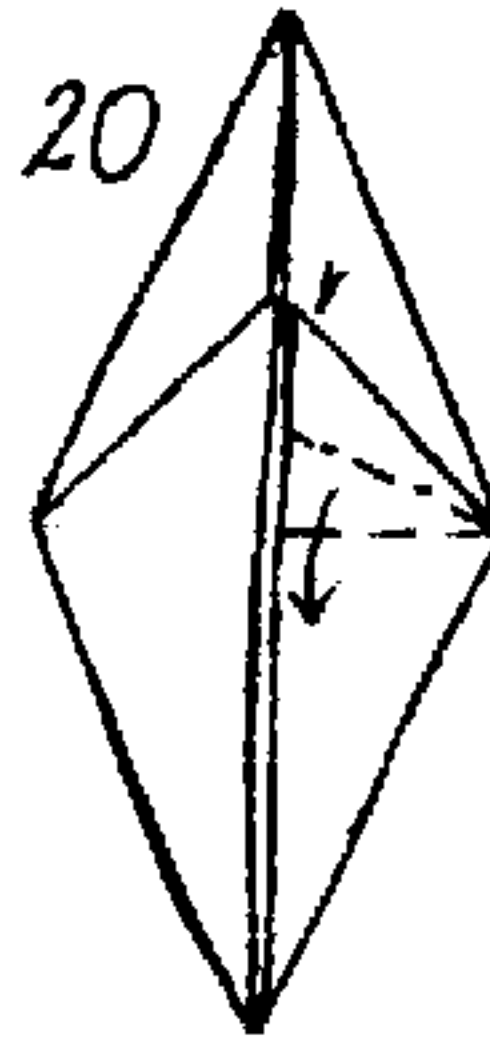
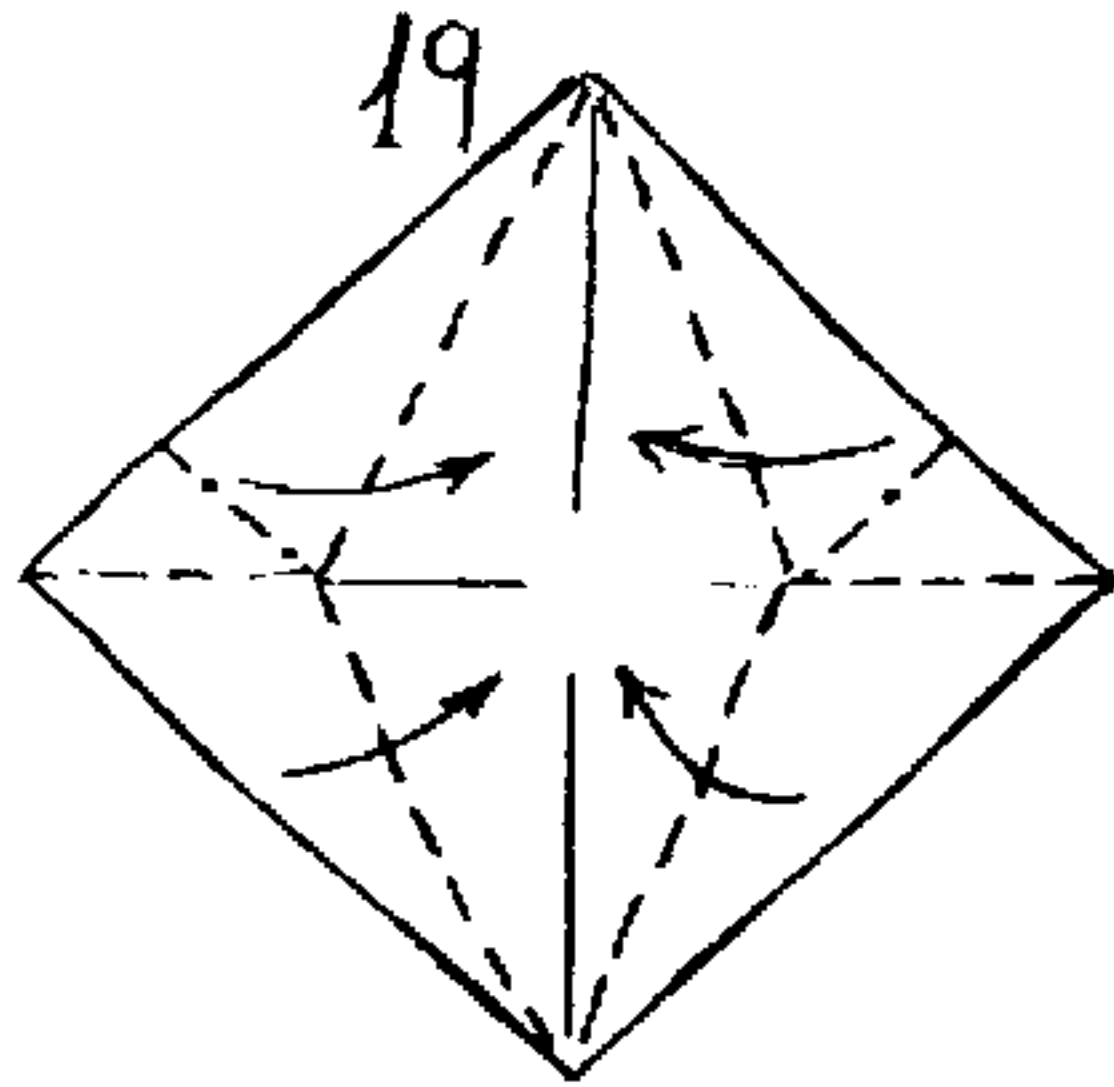

25

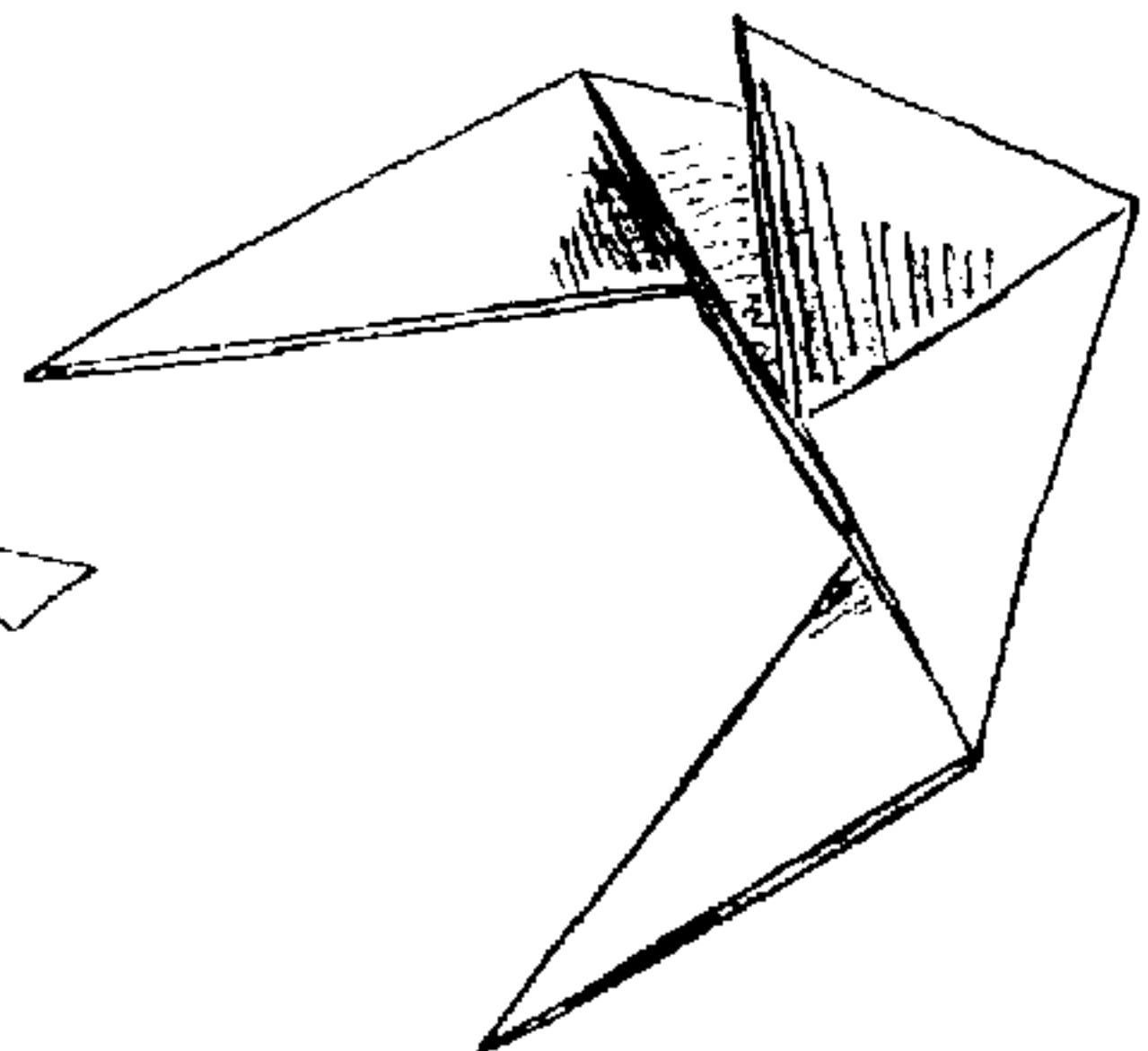
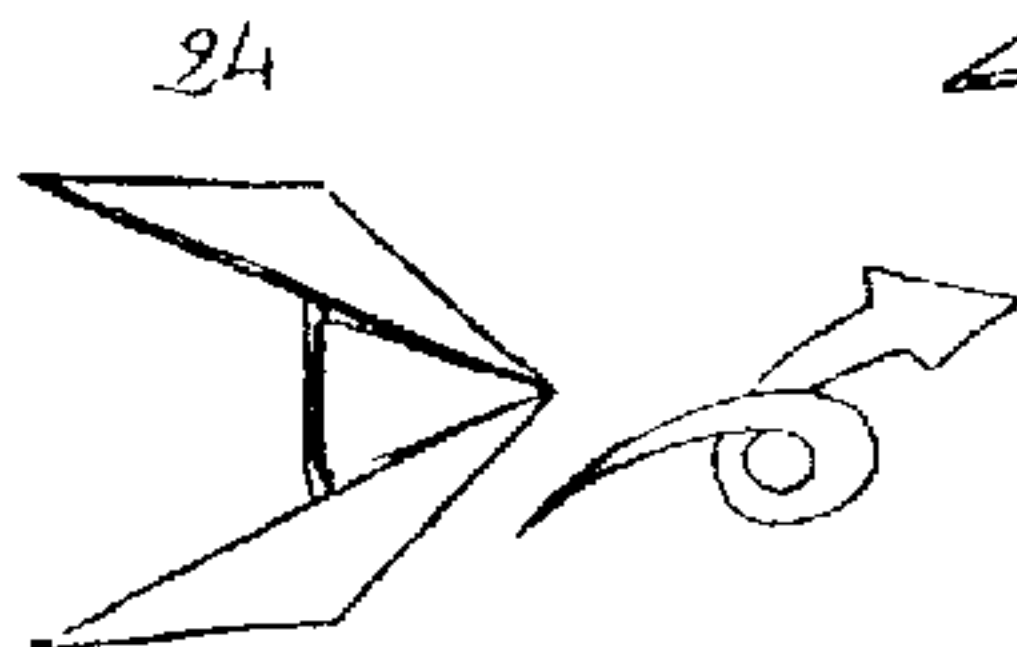

VÉRTEBRAS Y COSTILLAS

26

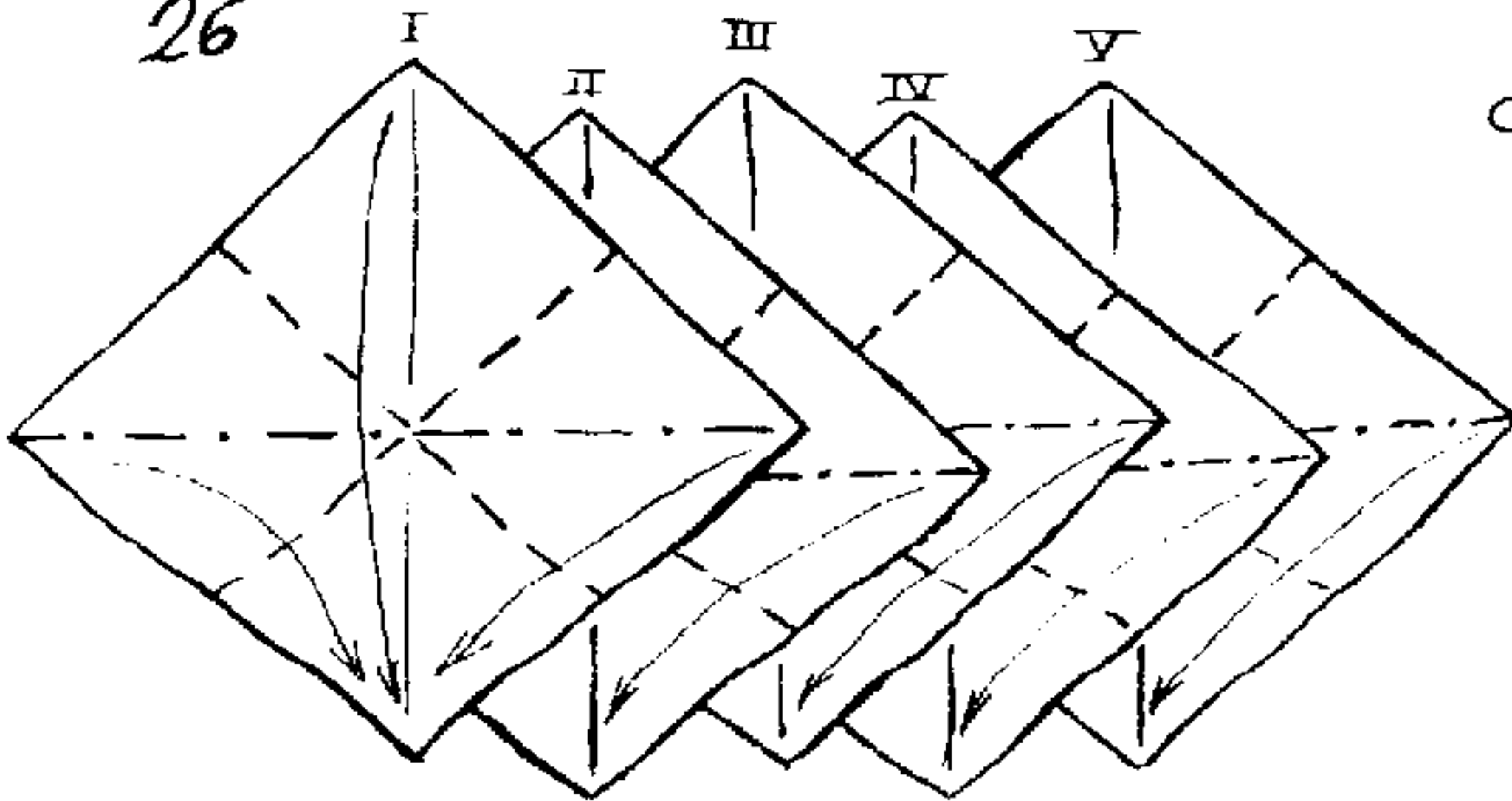

CINCO
BASES
PAJARO

27

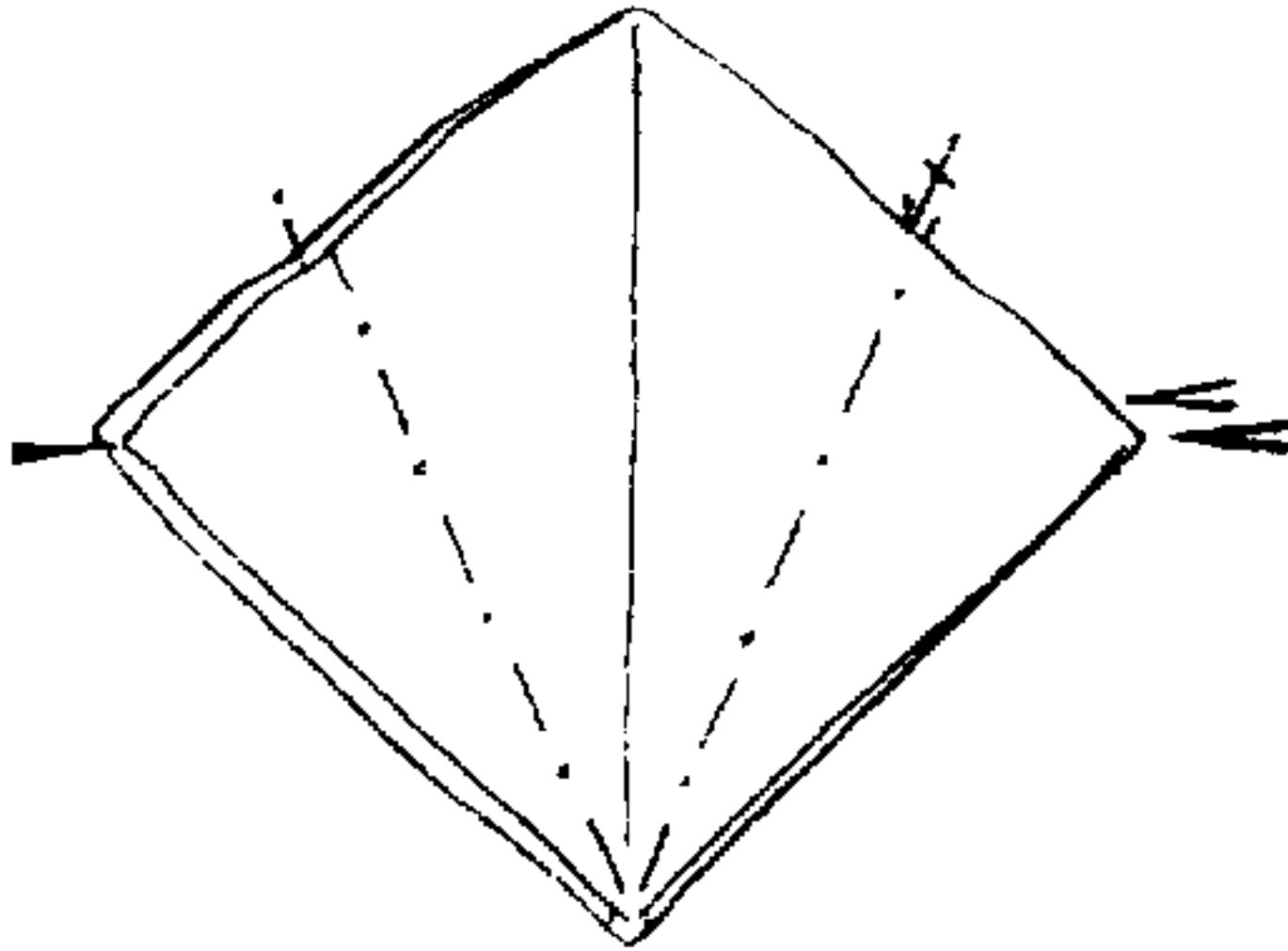

28

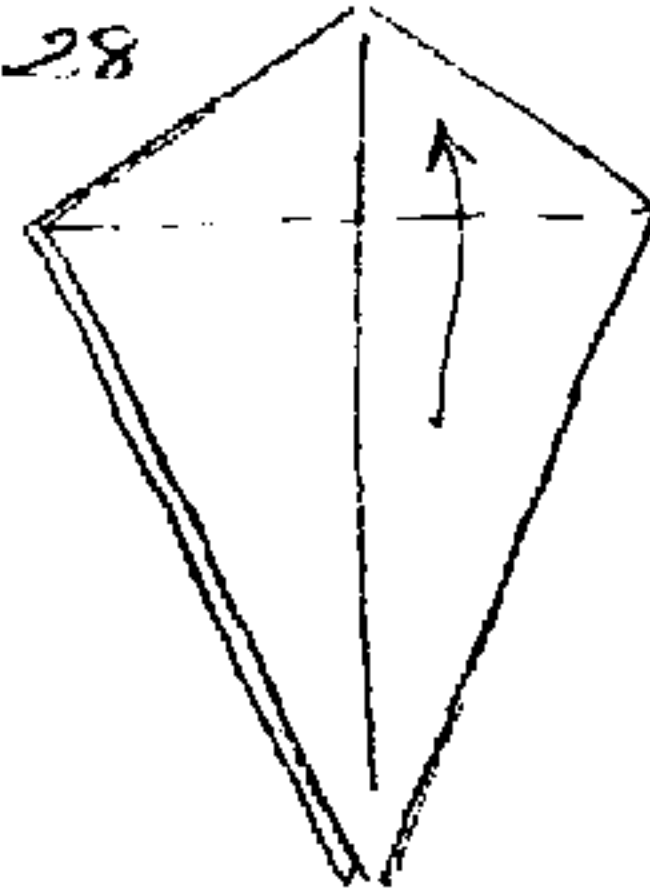

29

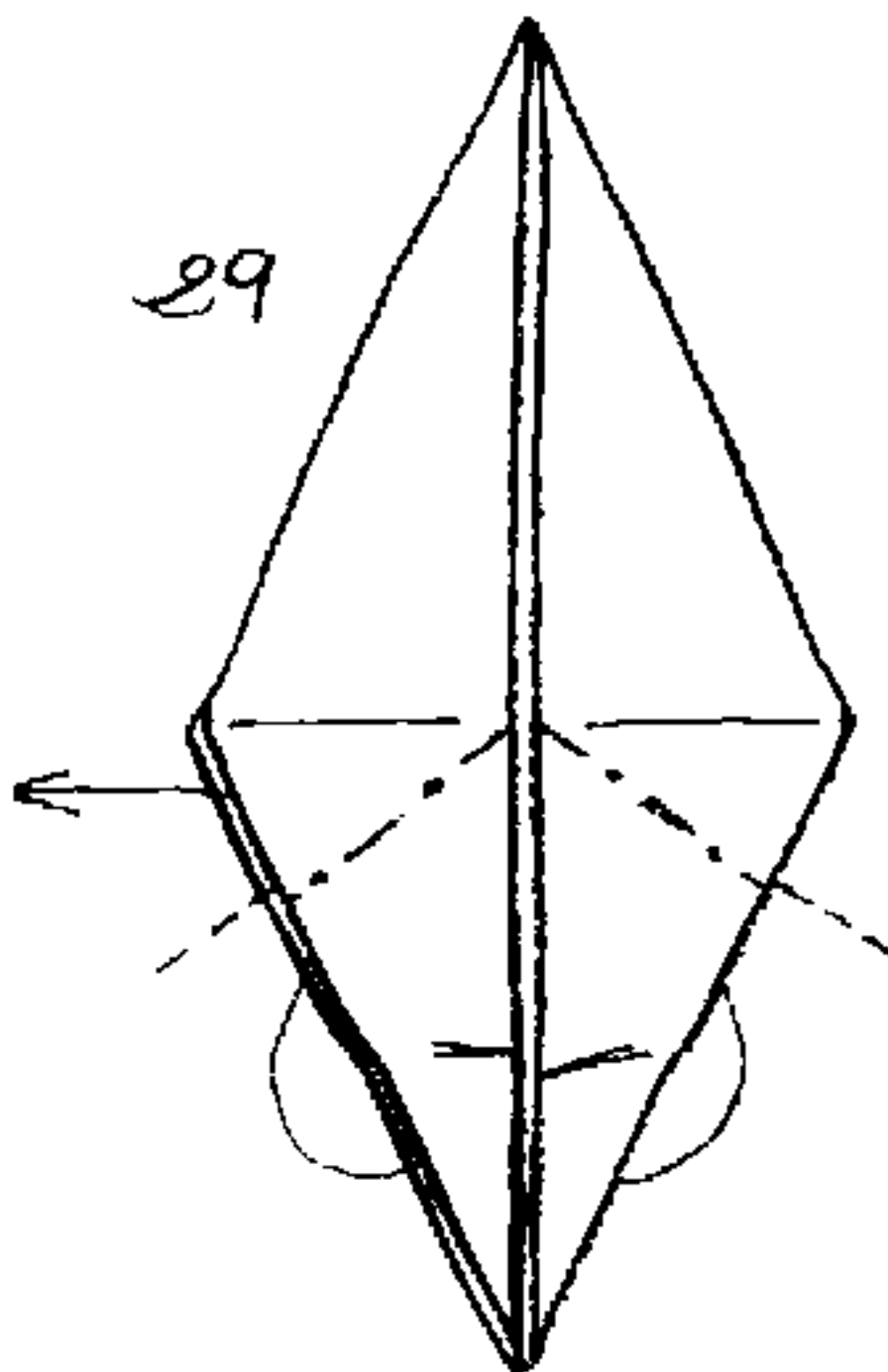

30

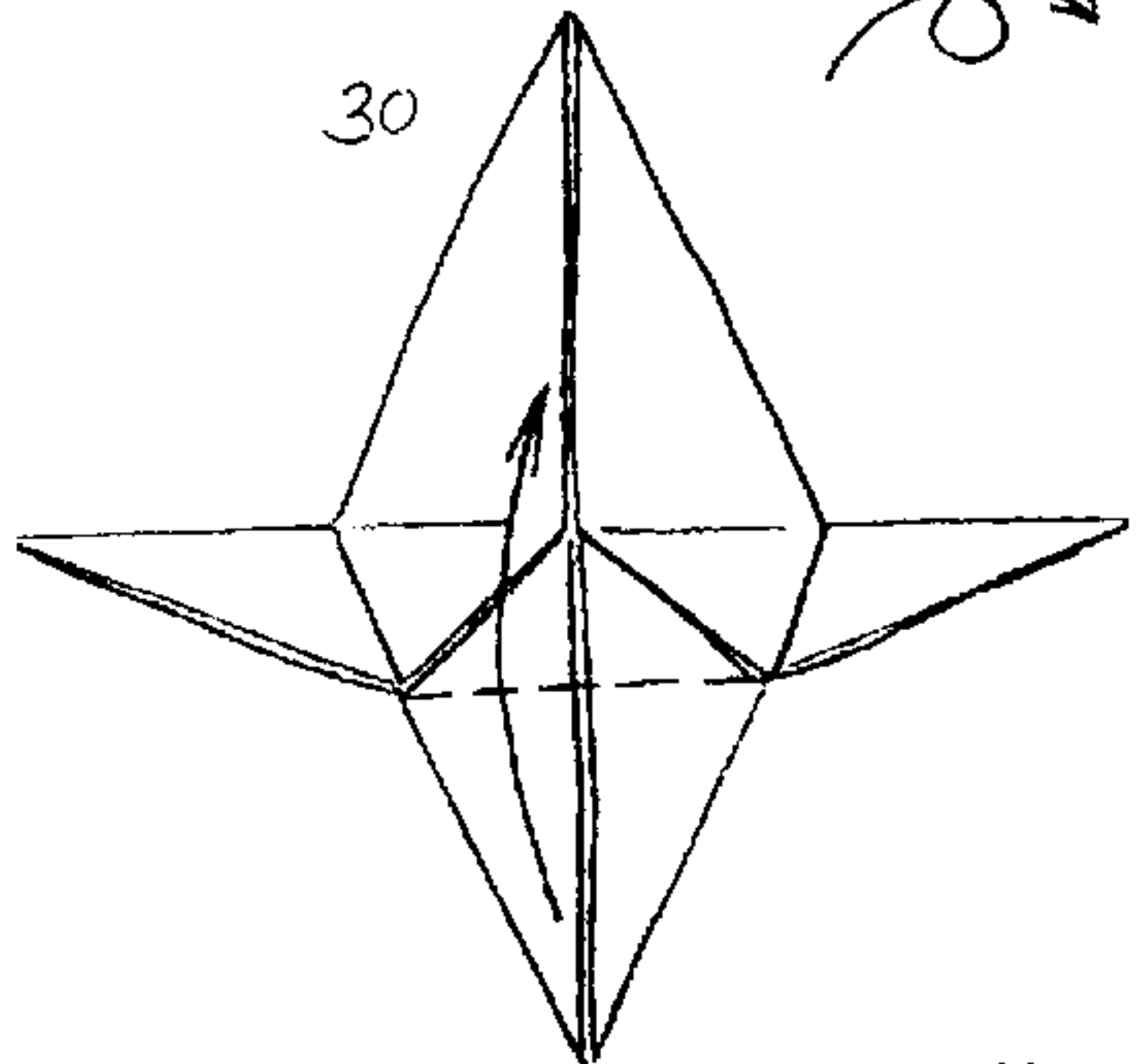

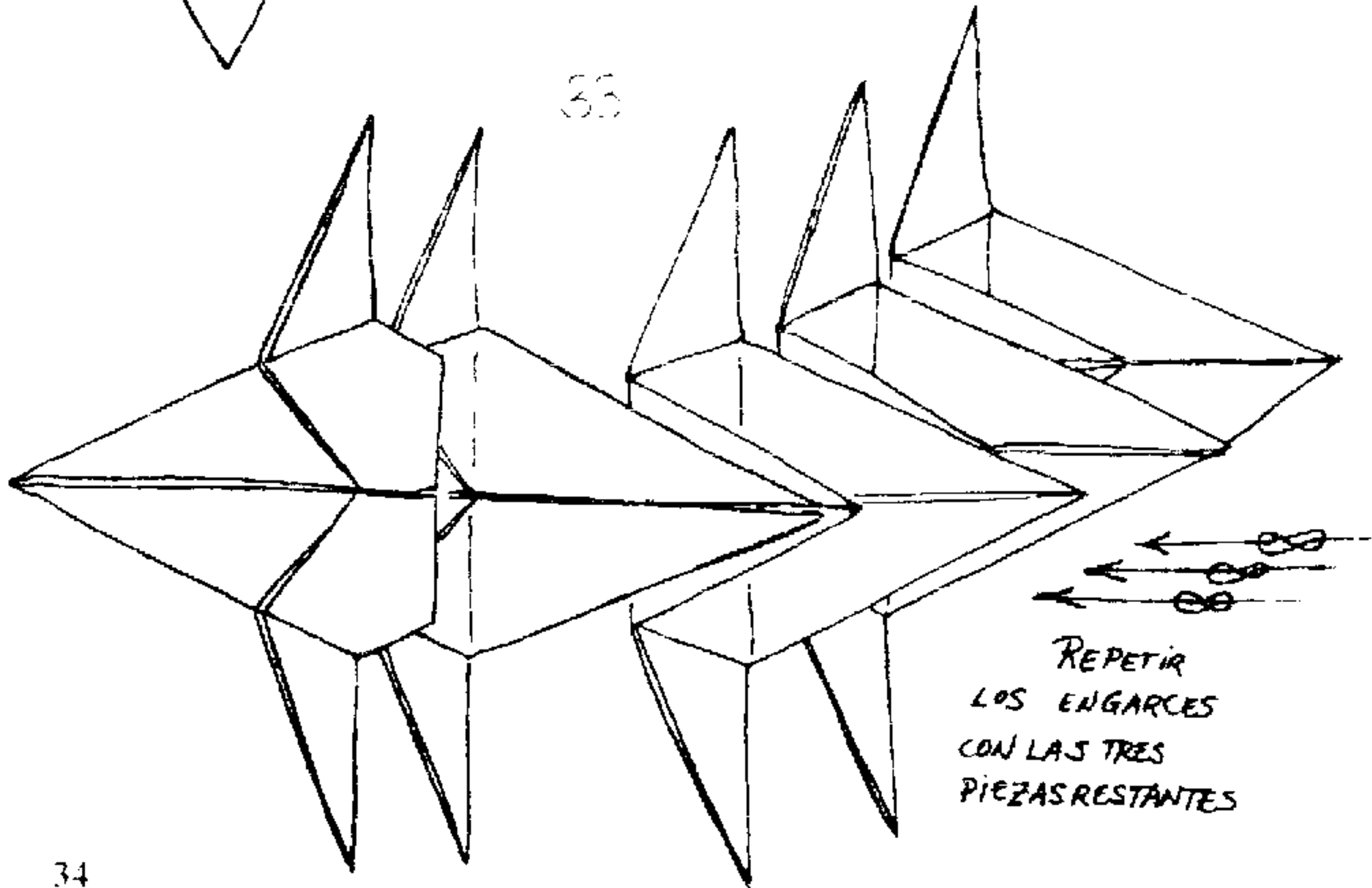
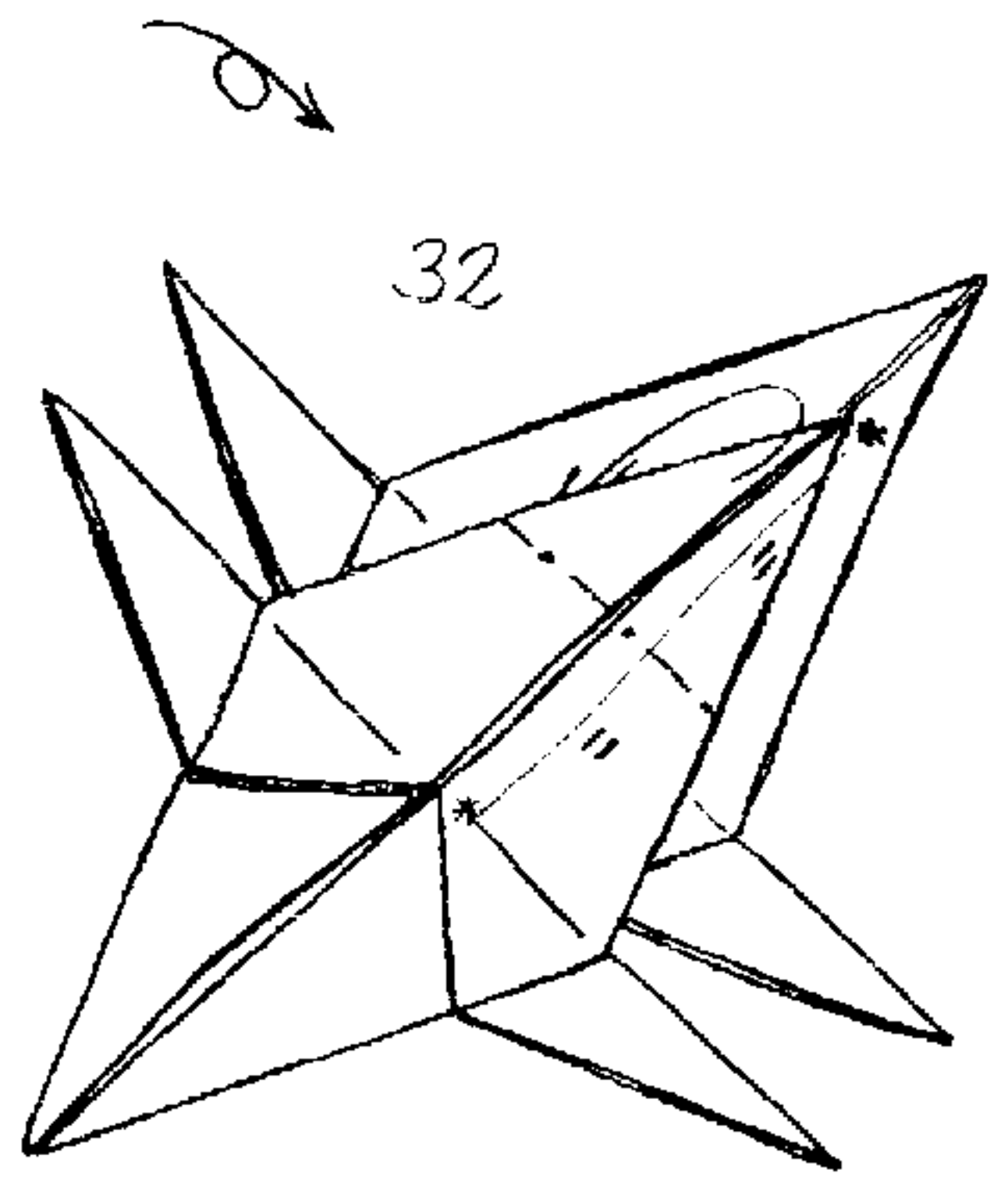
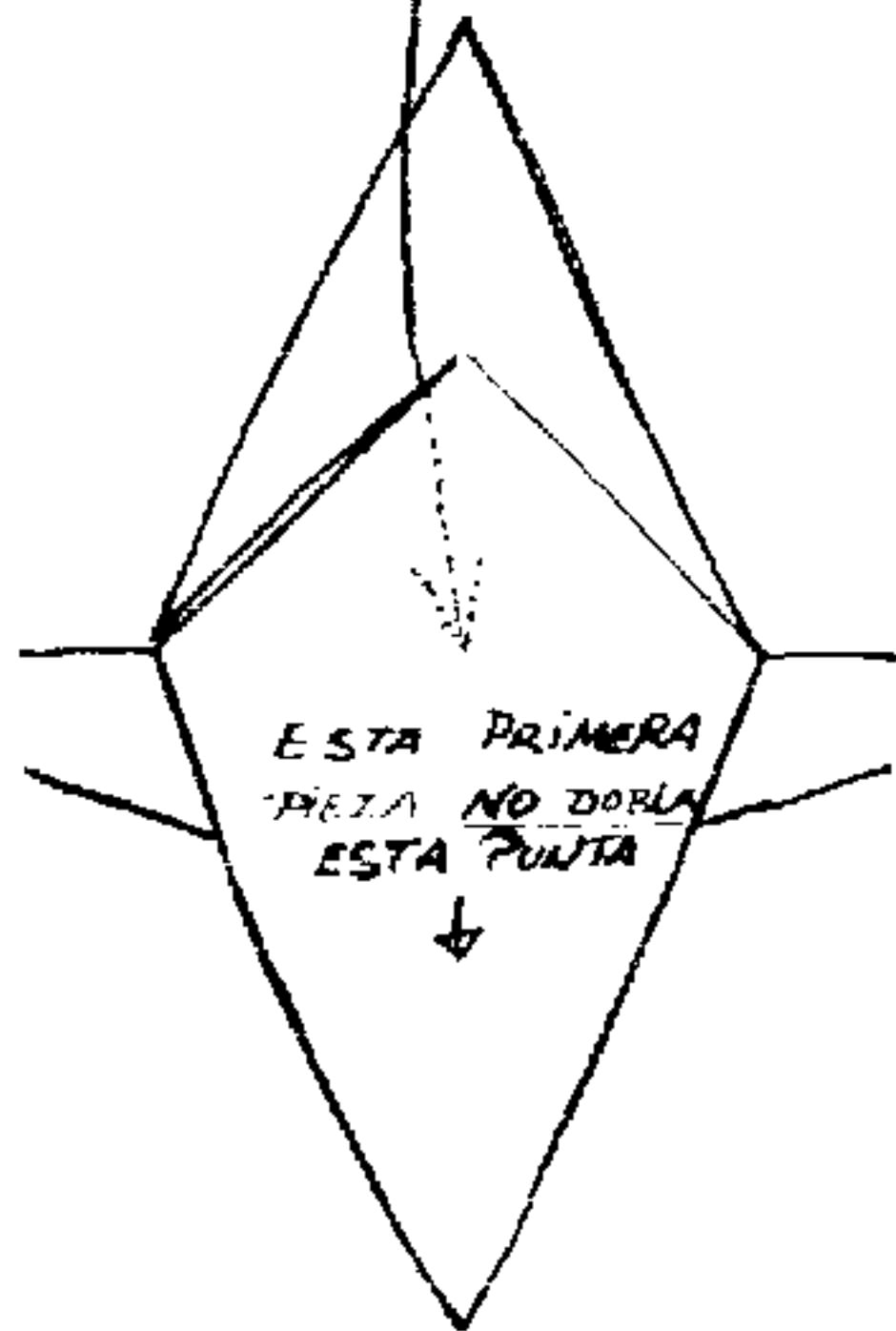
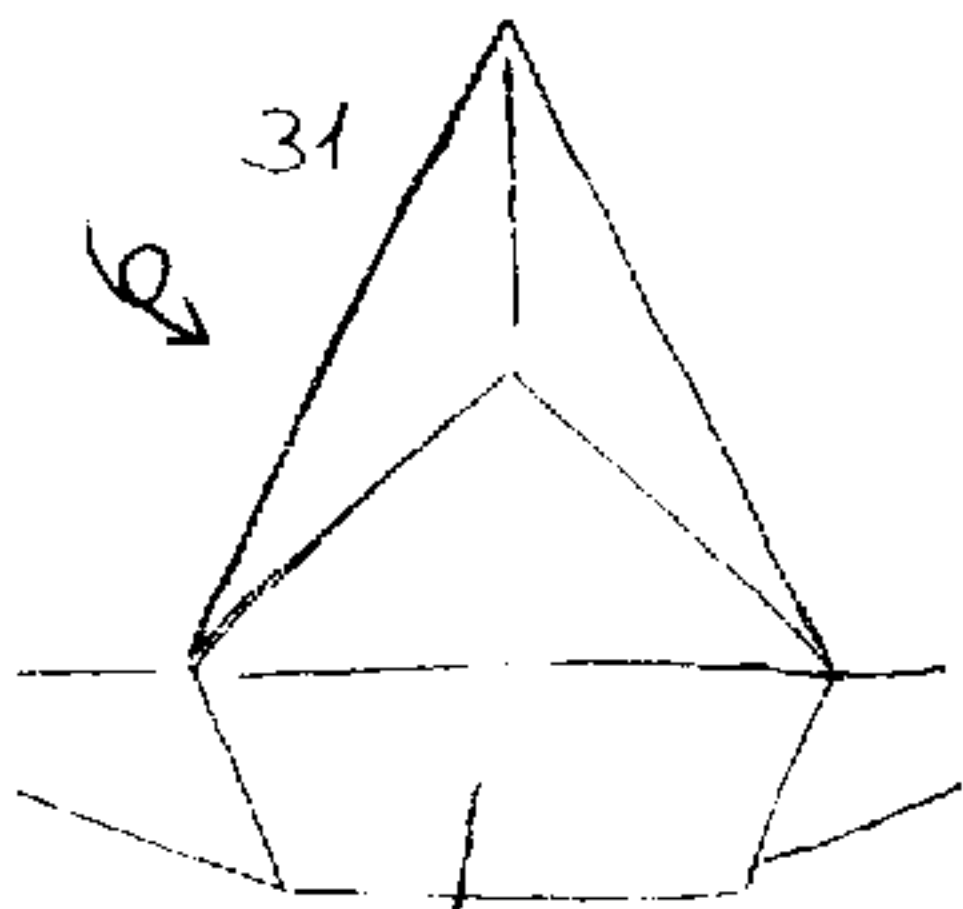

34

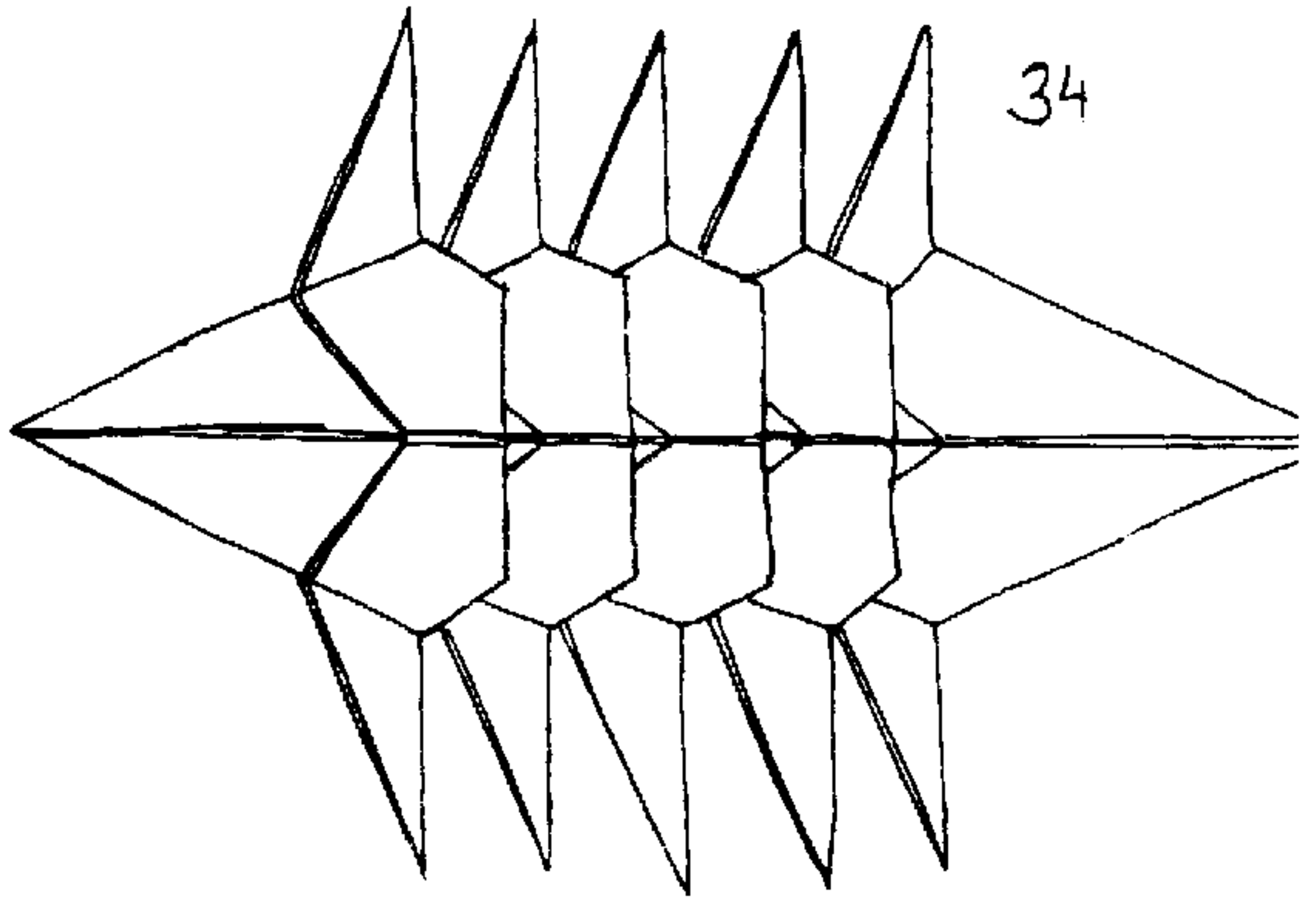

34

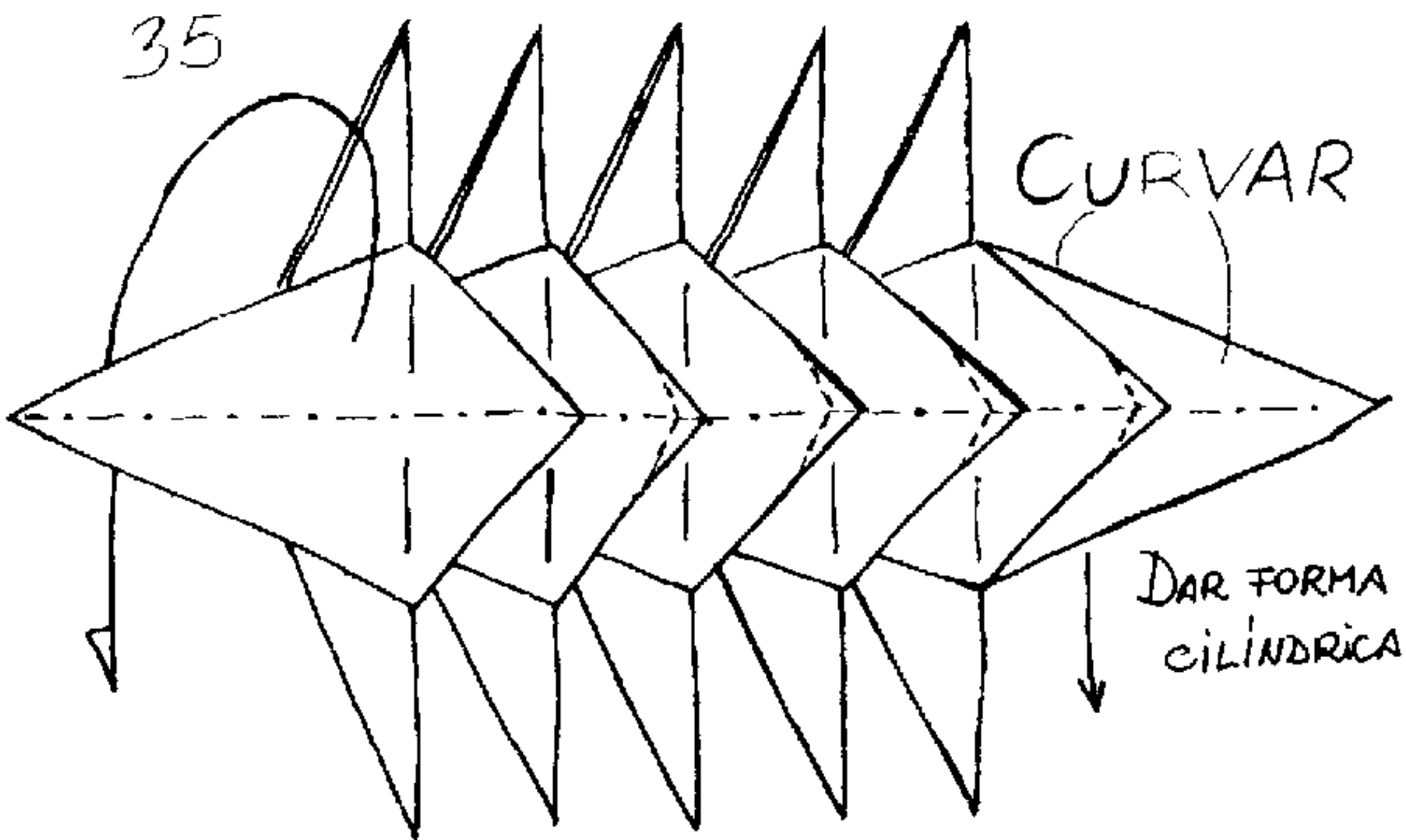

35

CURVAR

DAR FORMA CILINDRICA

36

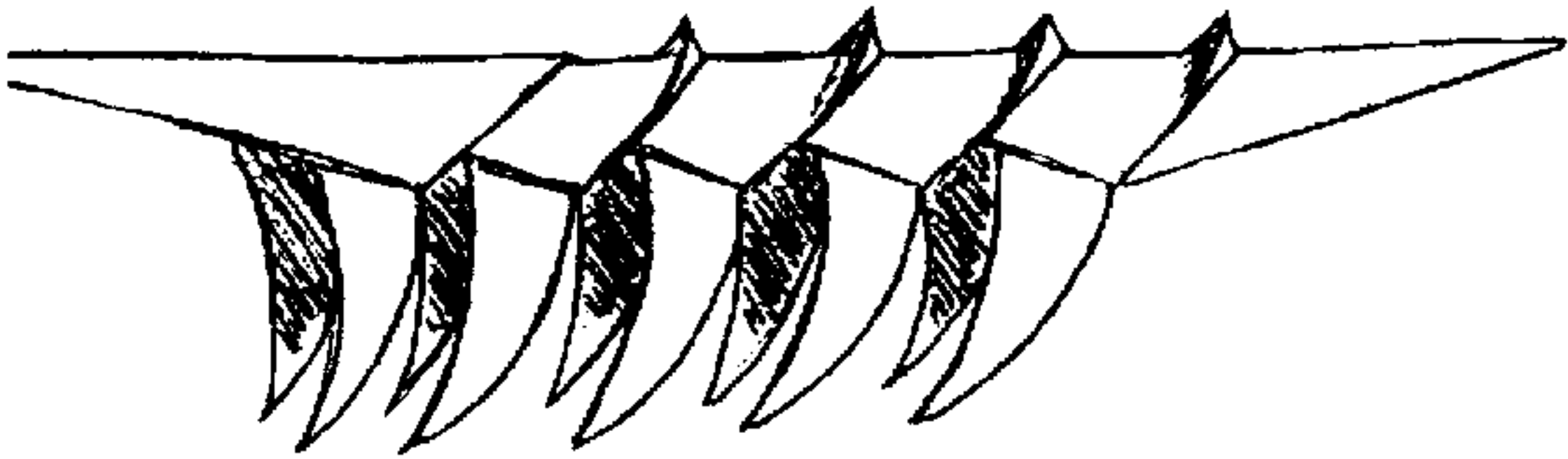

FÉMUR

IZQUIERDO

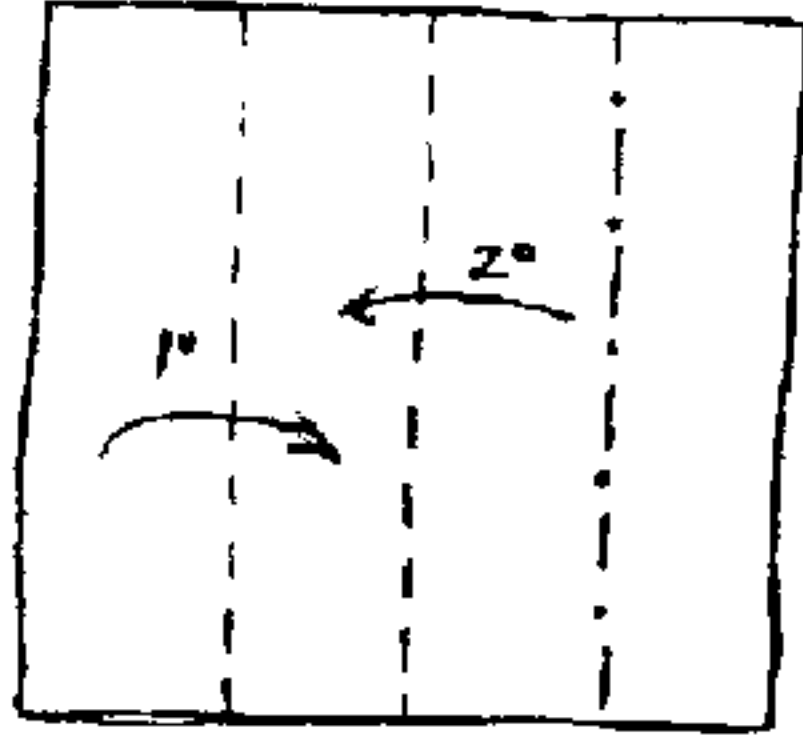

37

DERECHO

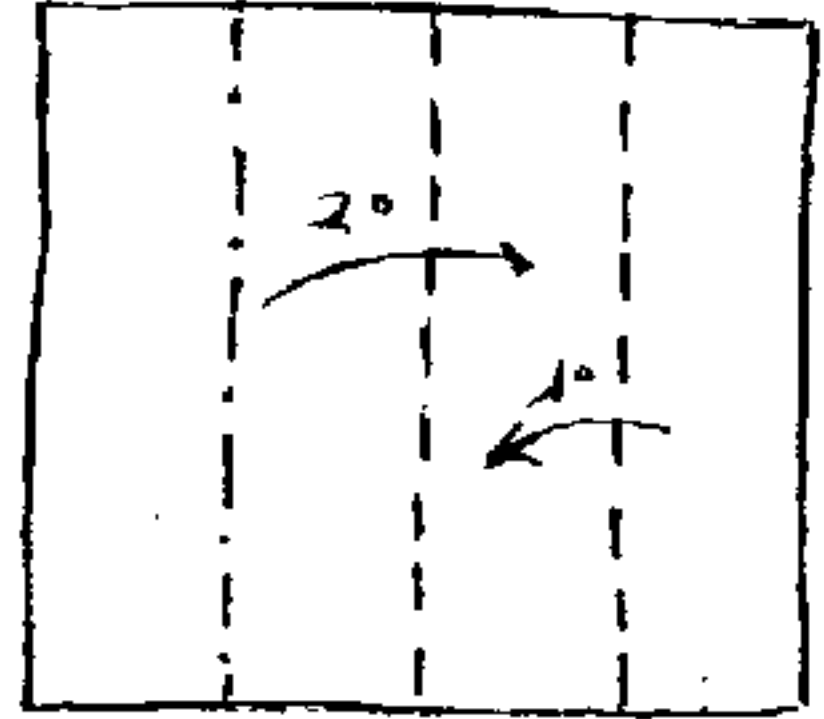

38

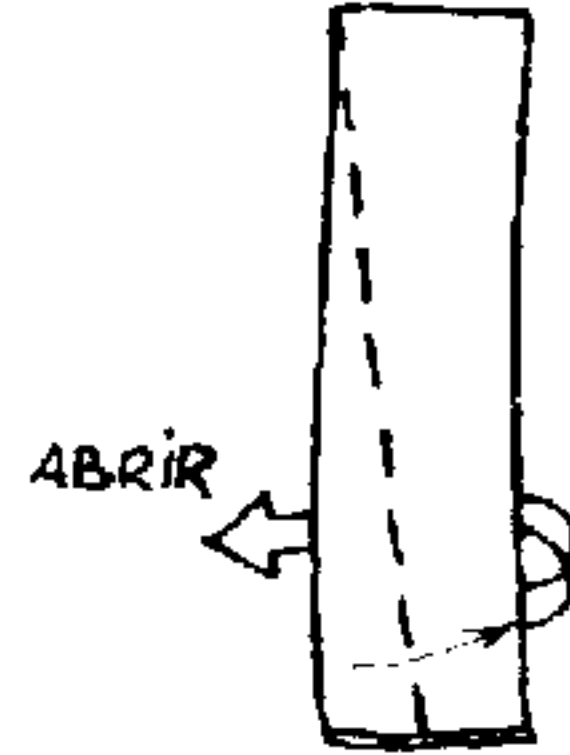

39

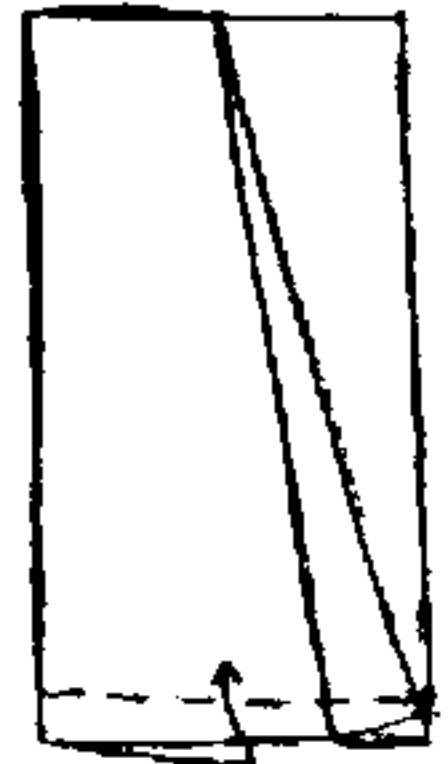

(110)



PATAS

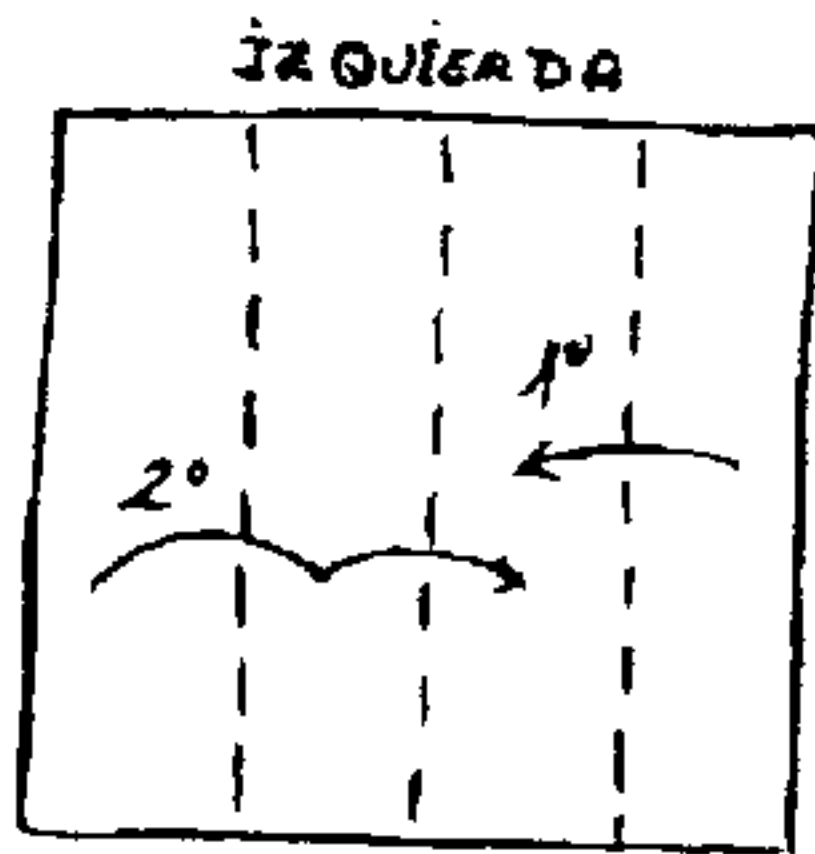

41

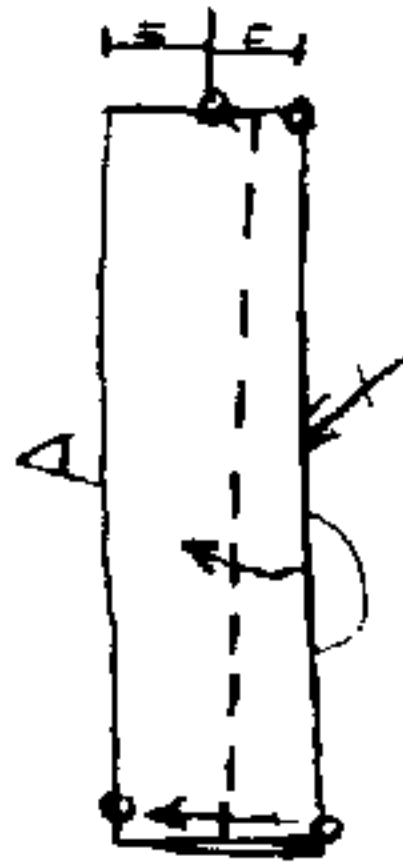
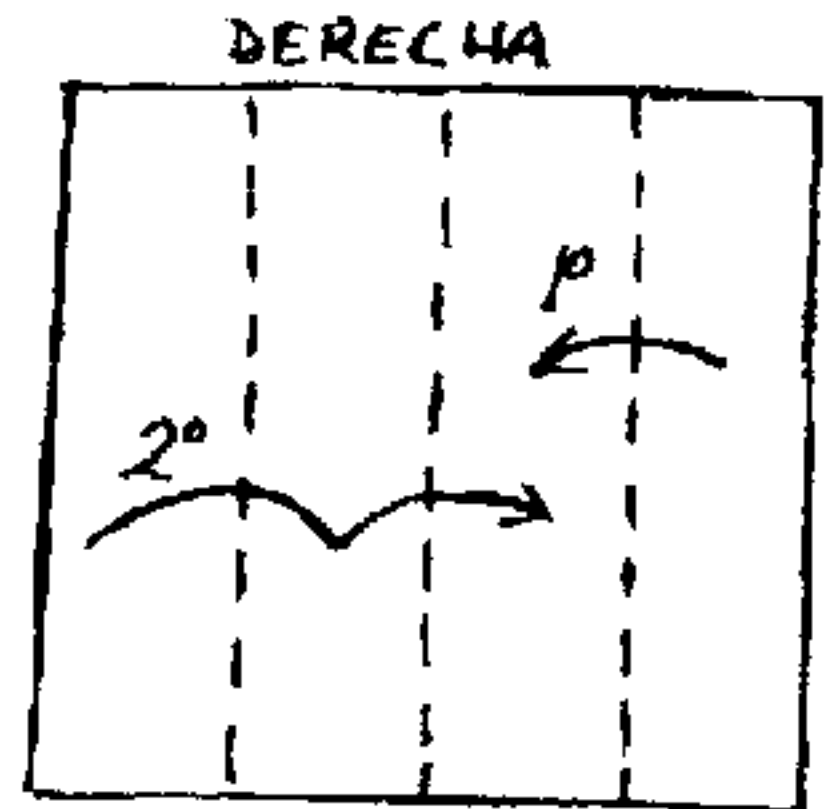

42

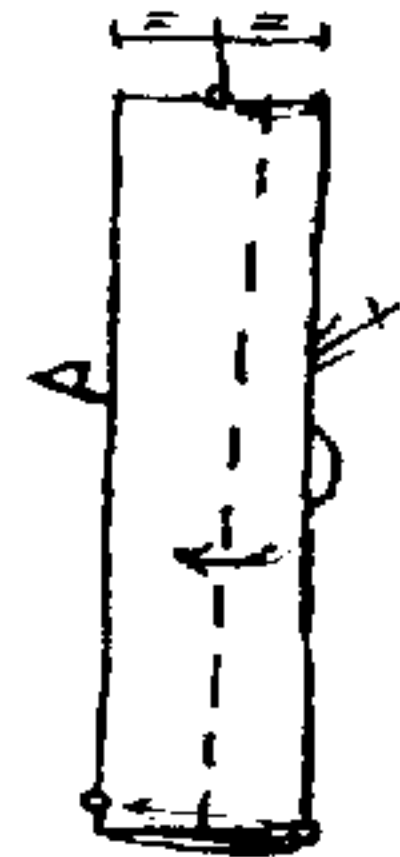

DESPLEGAR

43

DESPLEGAR



44

VOLVER
A CERRAR



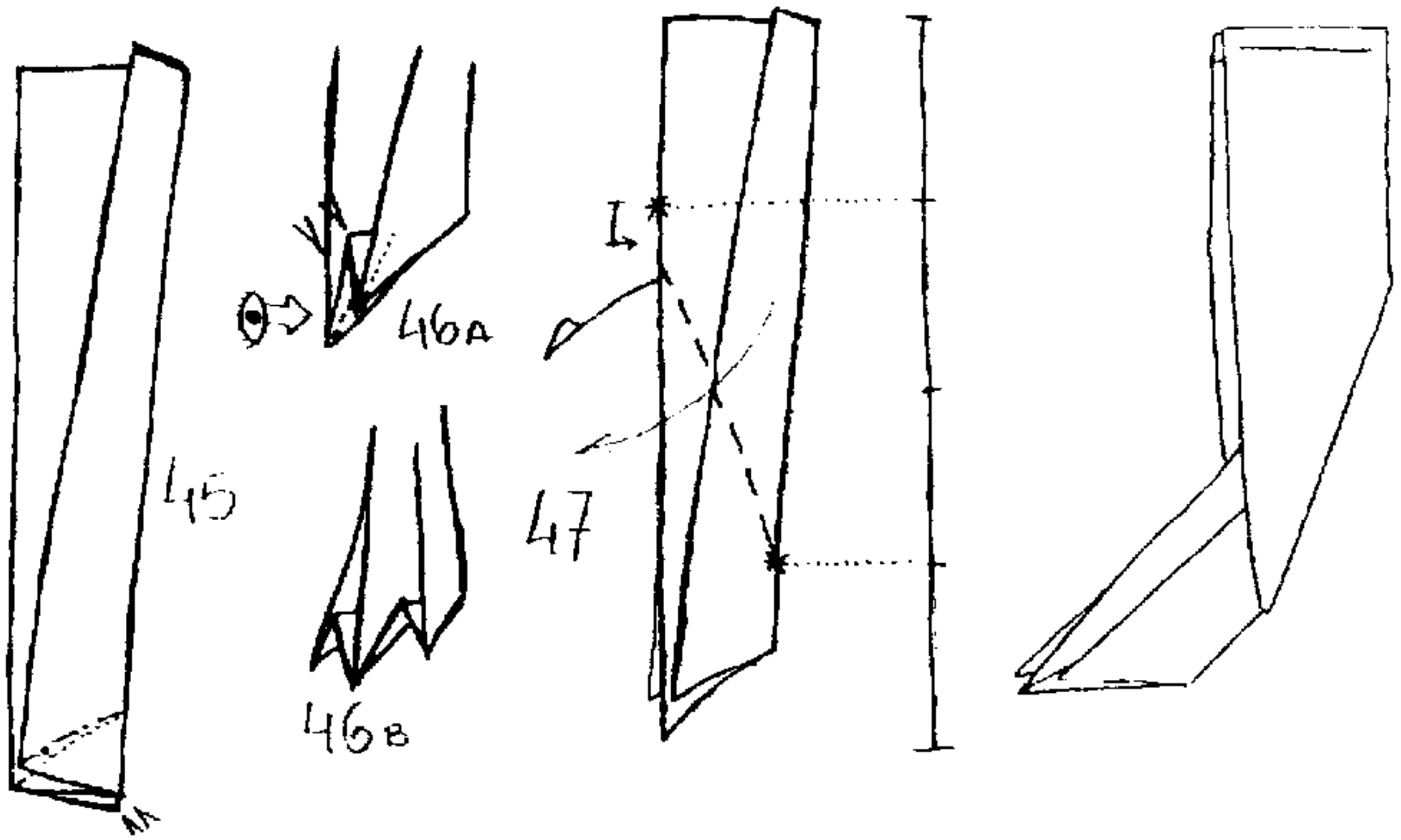

48

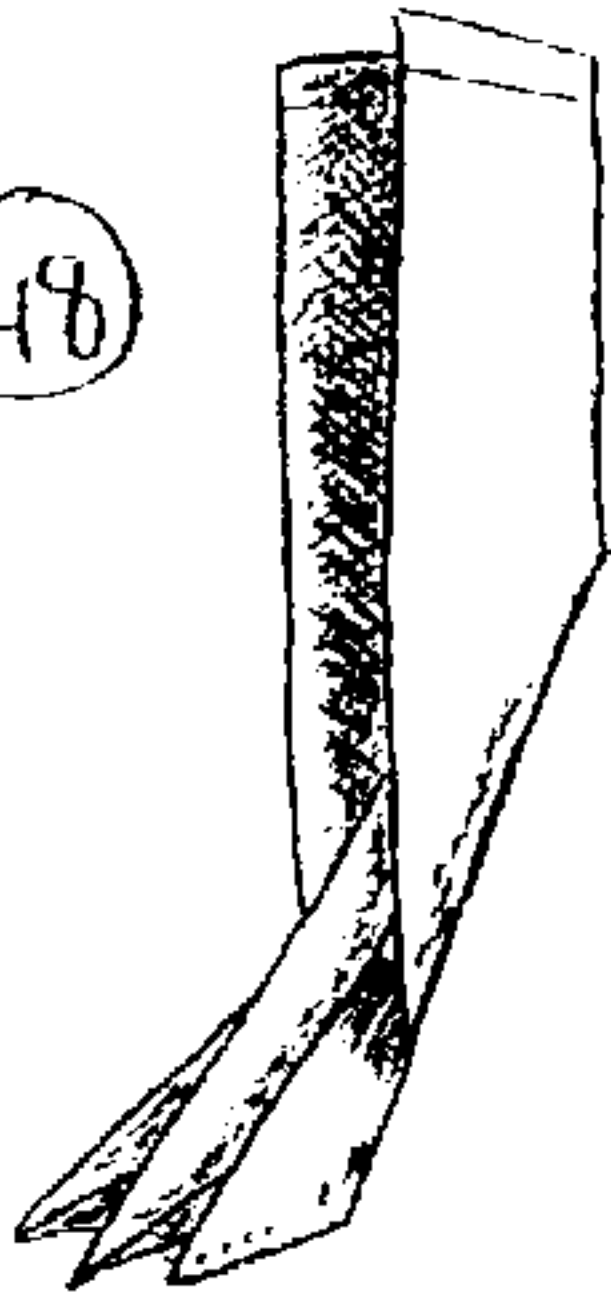

UNIÓN DEL FÉMUR Y LA PATA

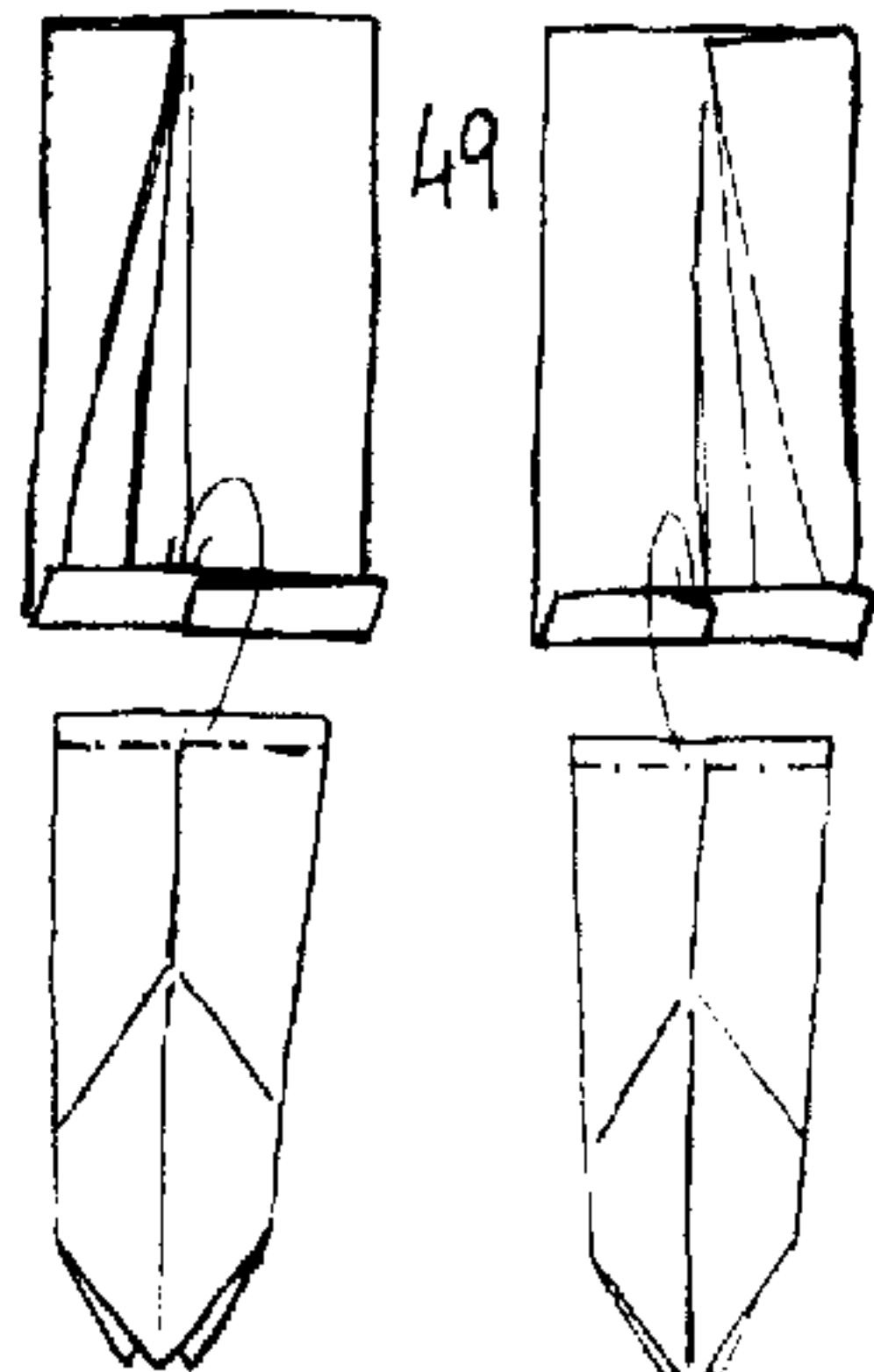

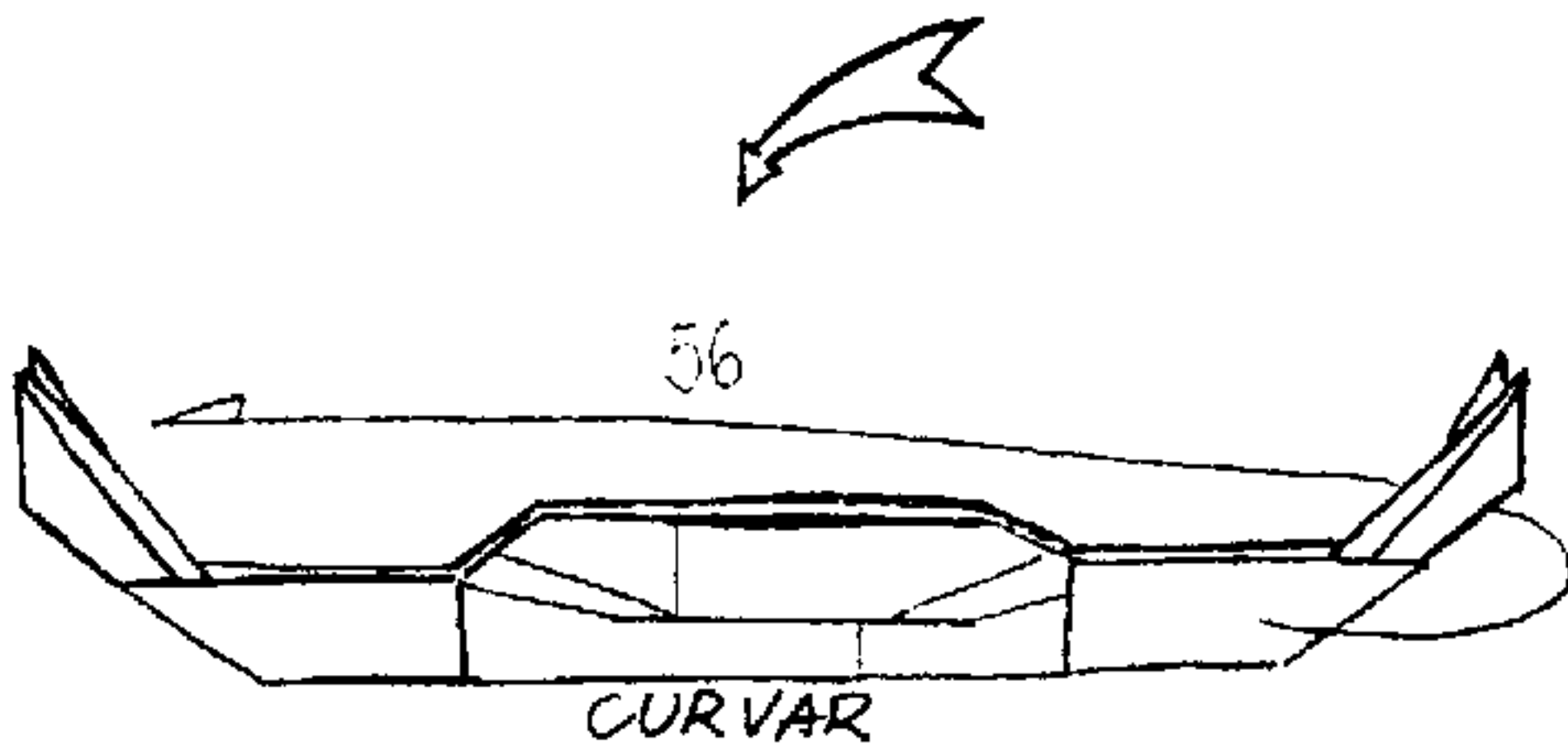
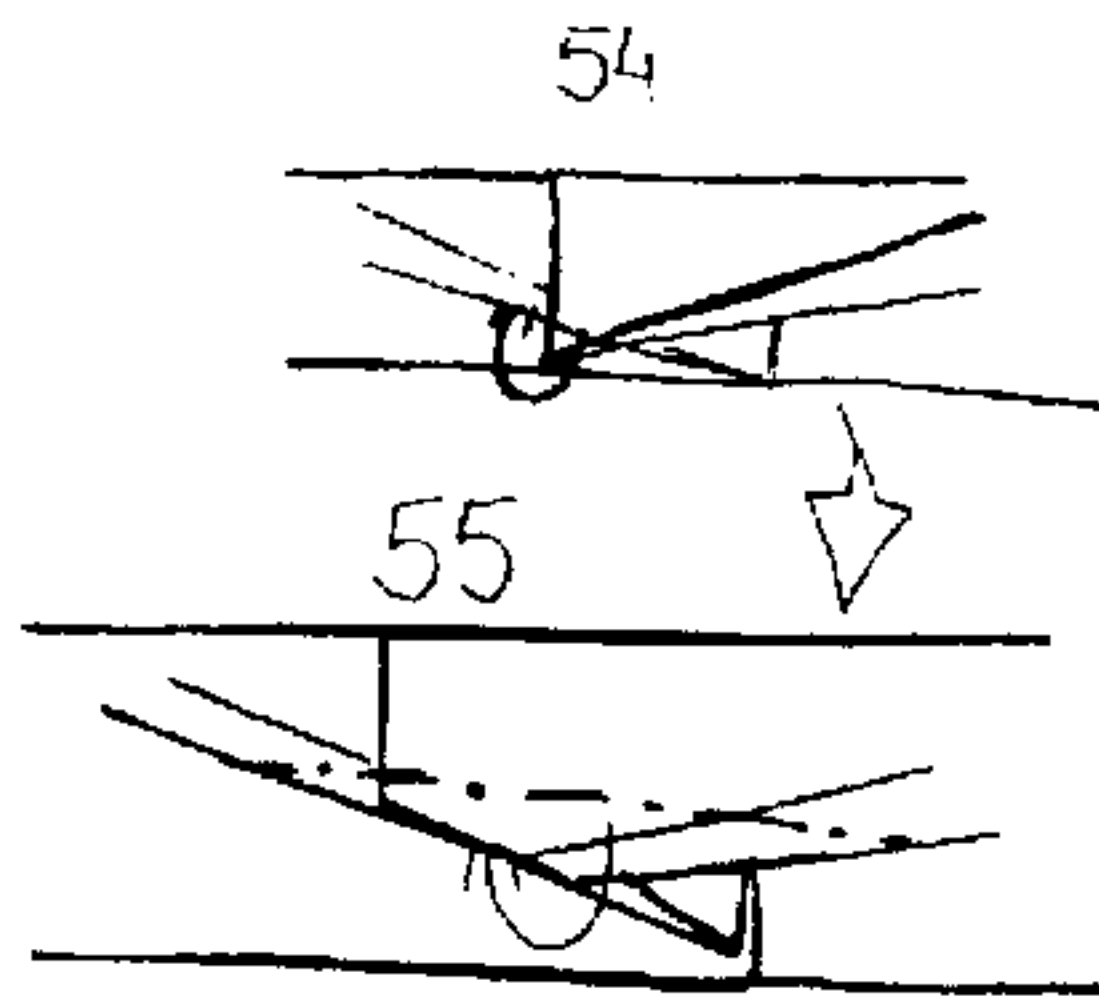
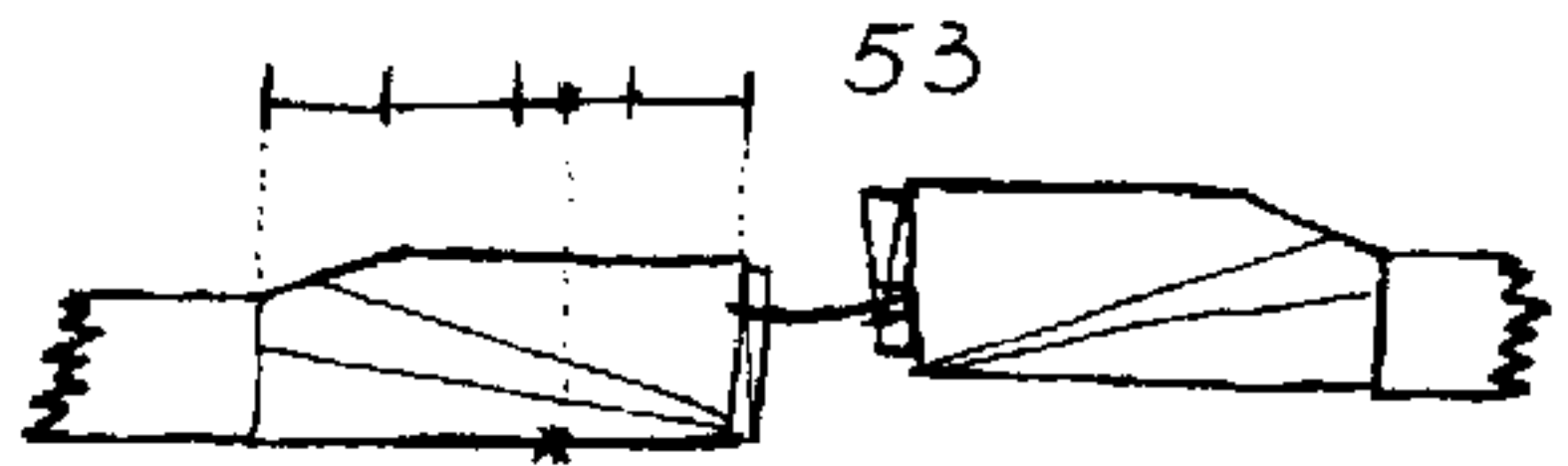
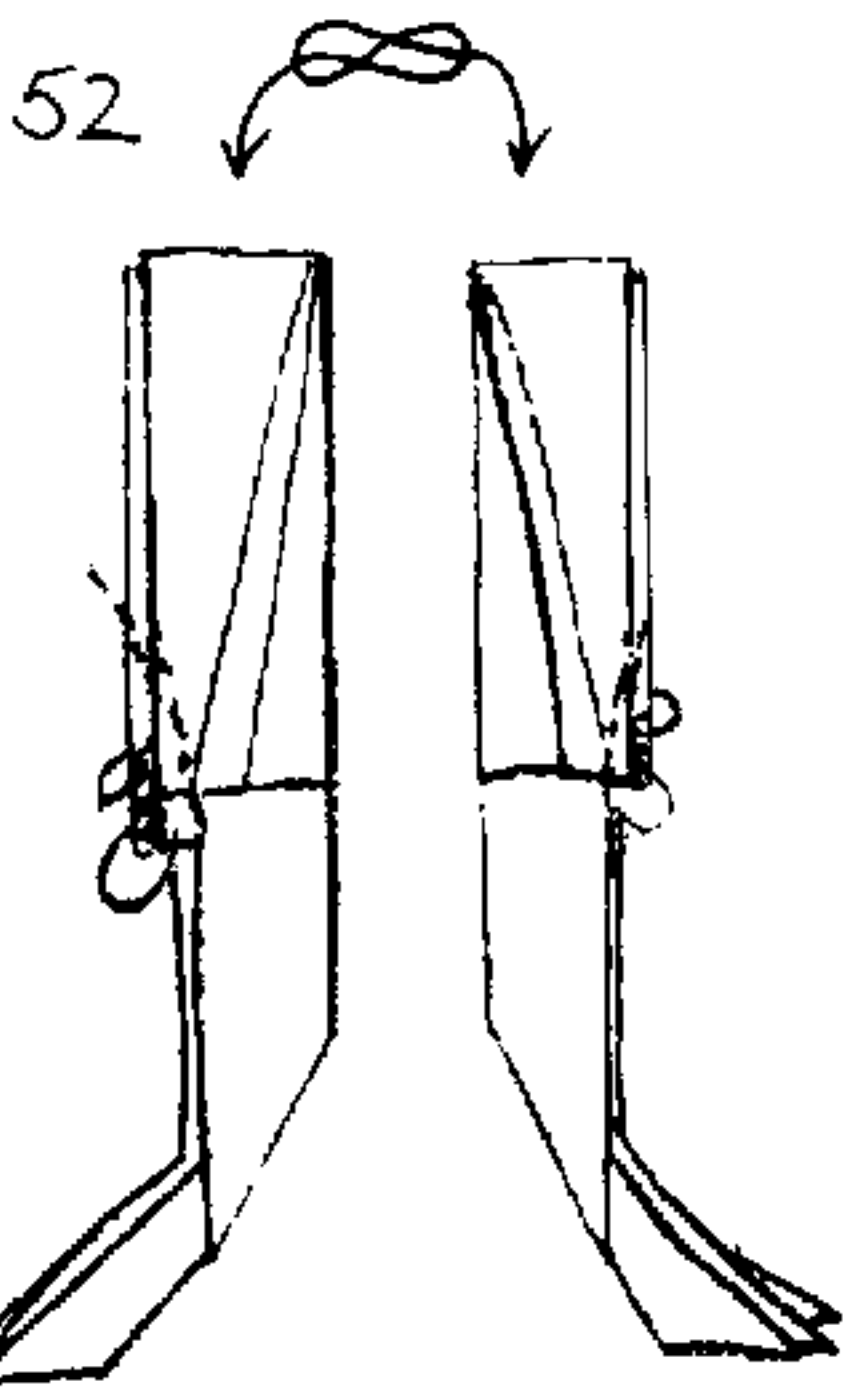
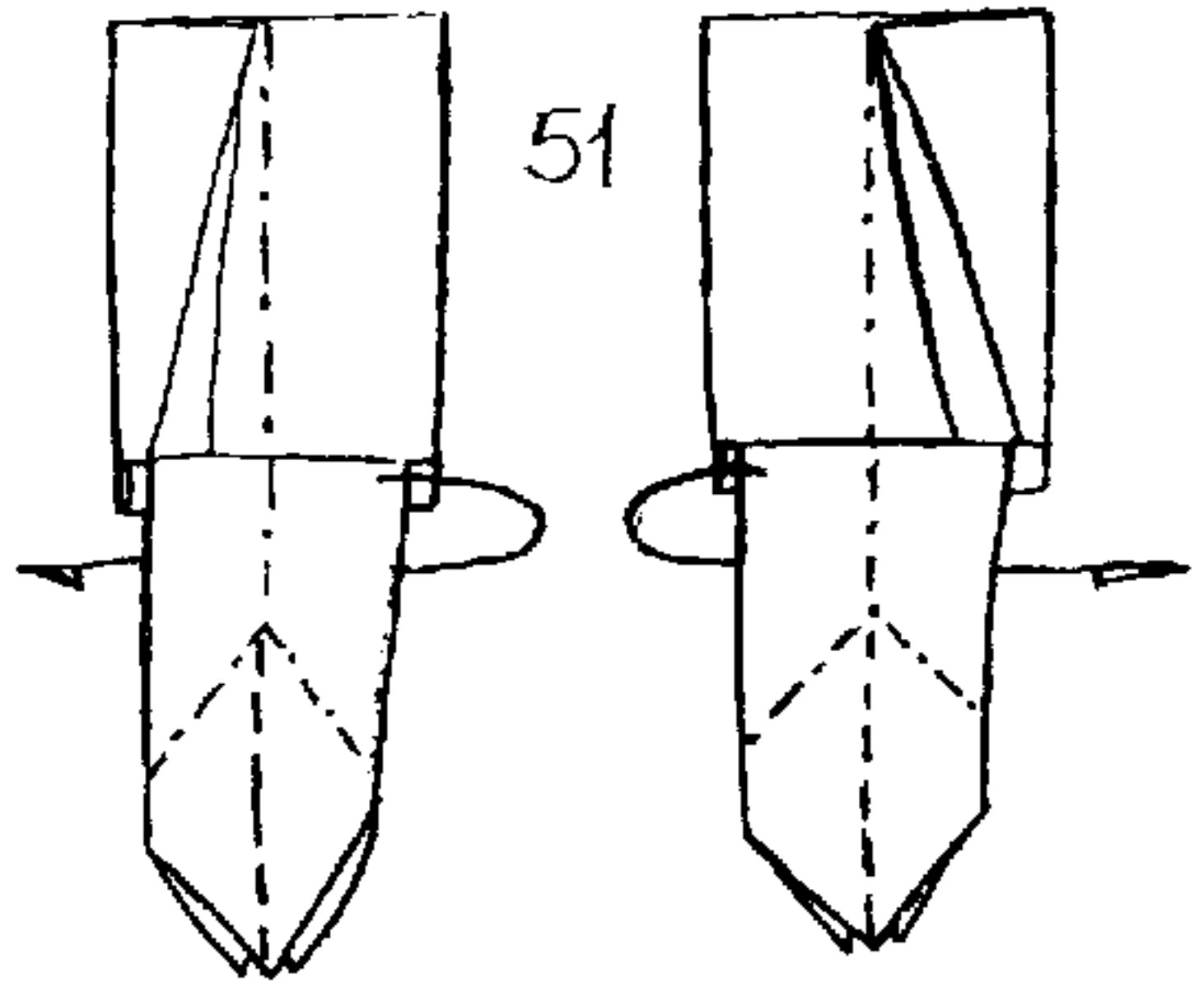
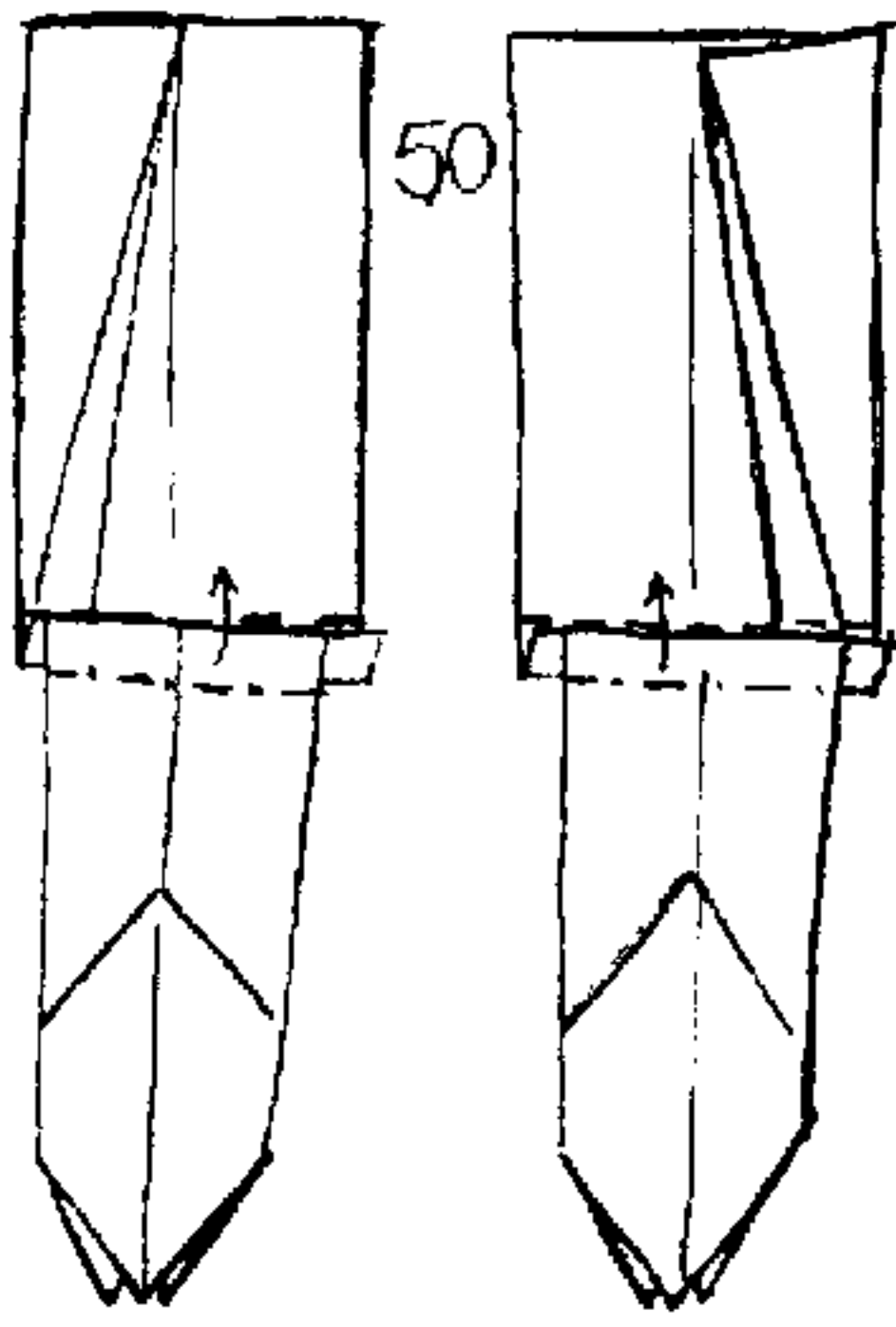

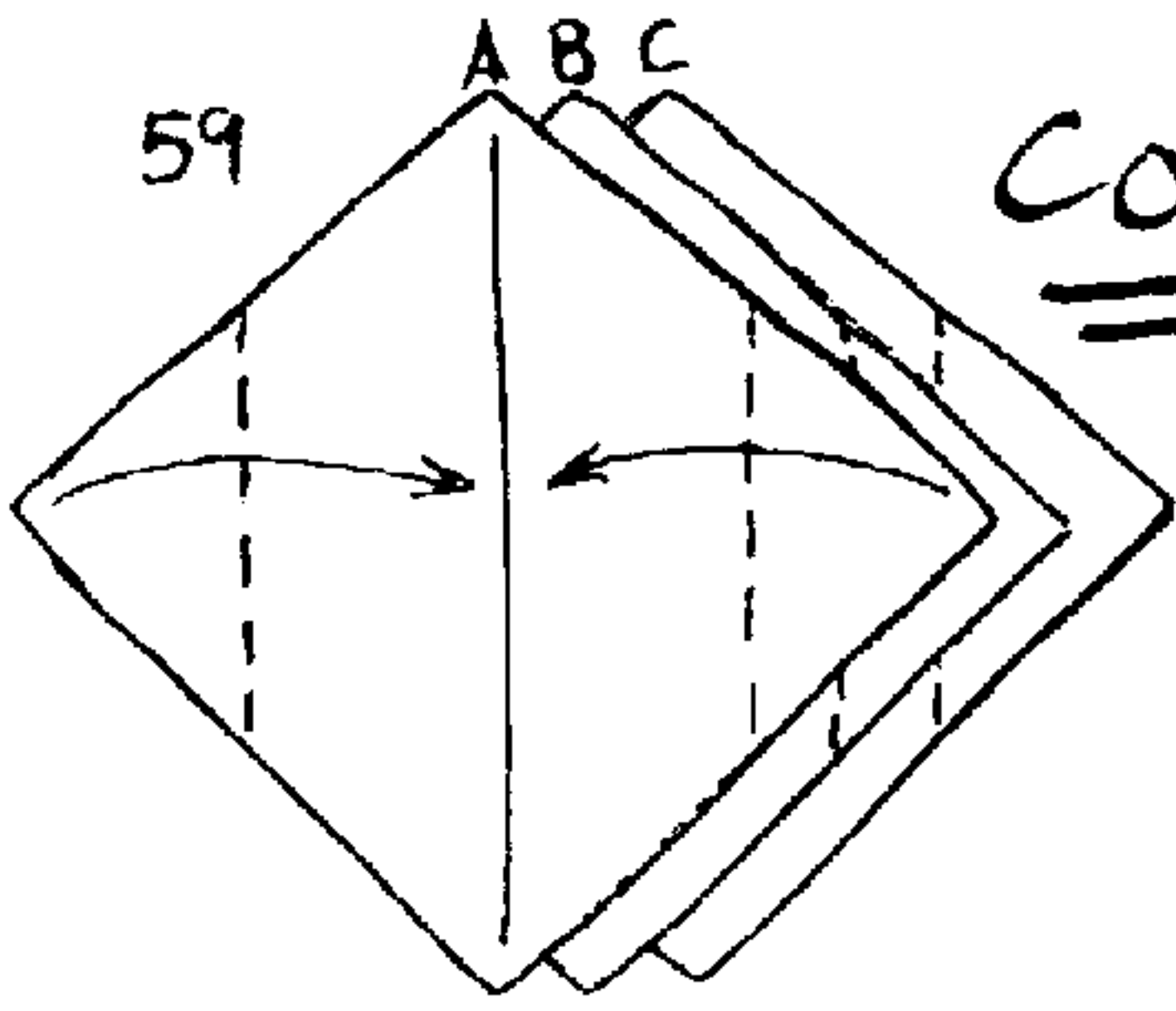
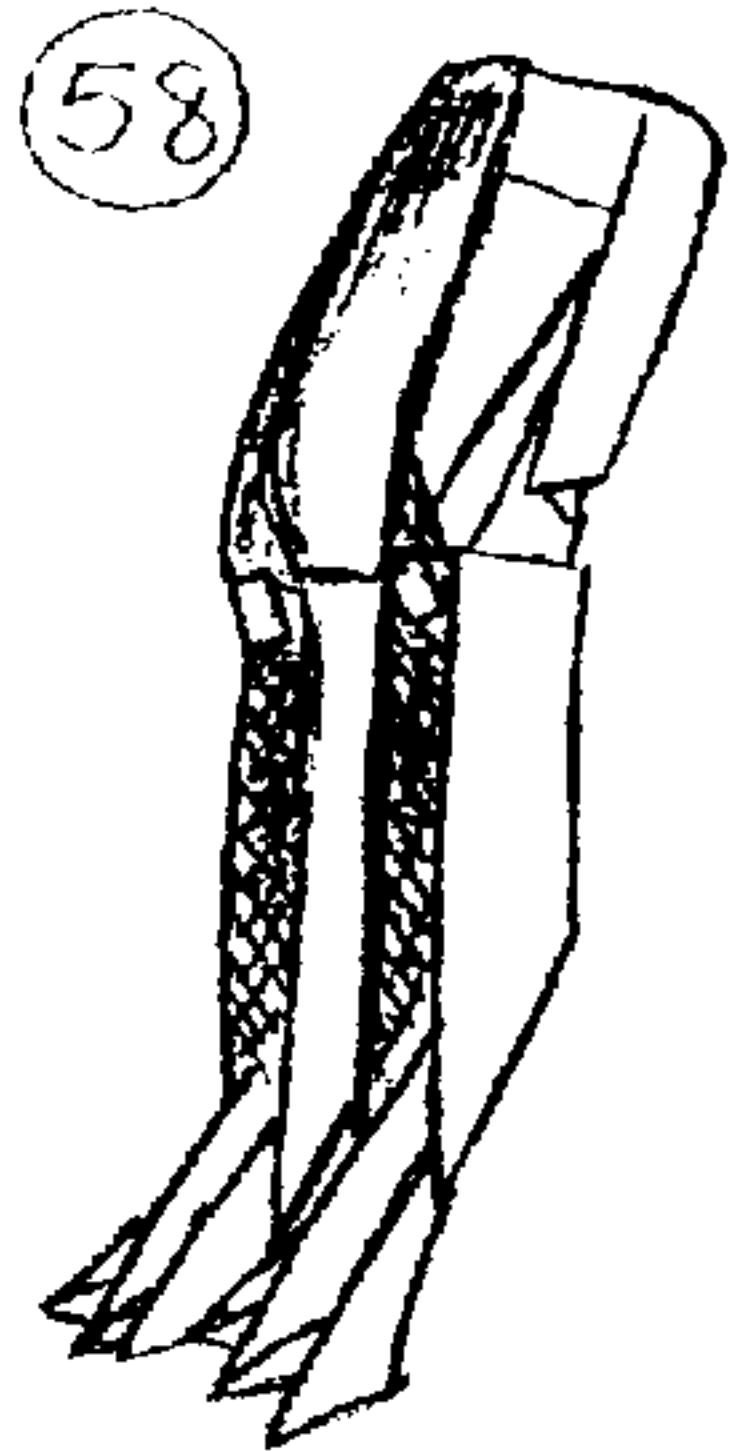
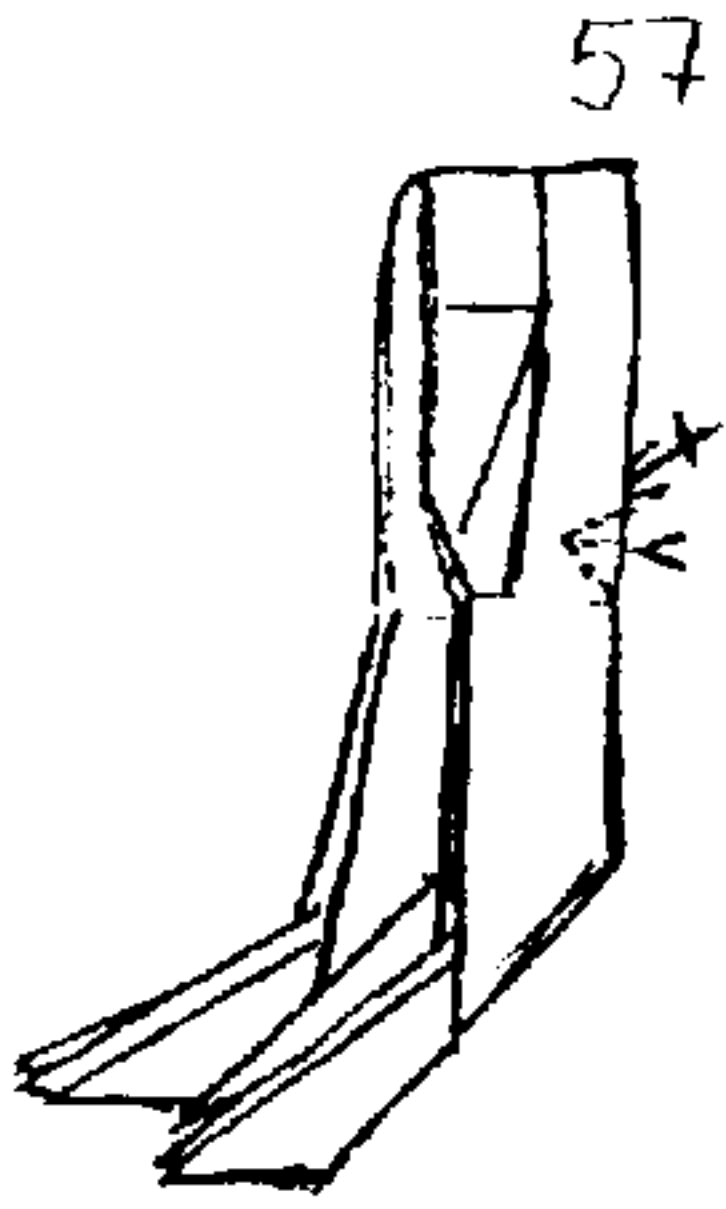

COLA

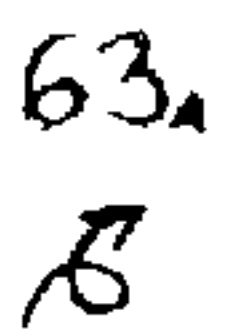
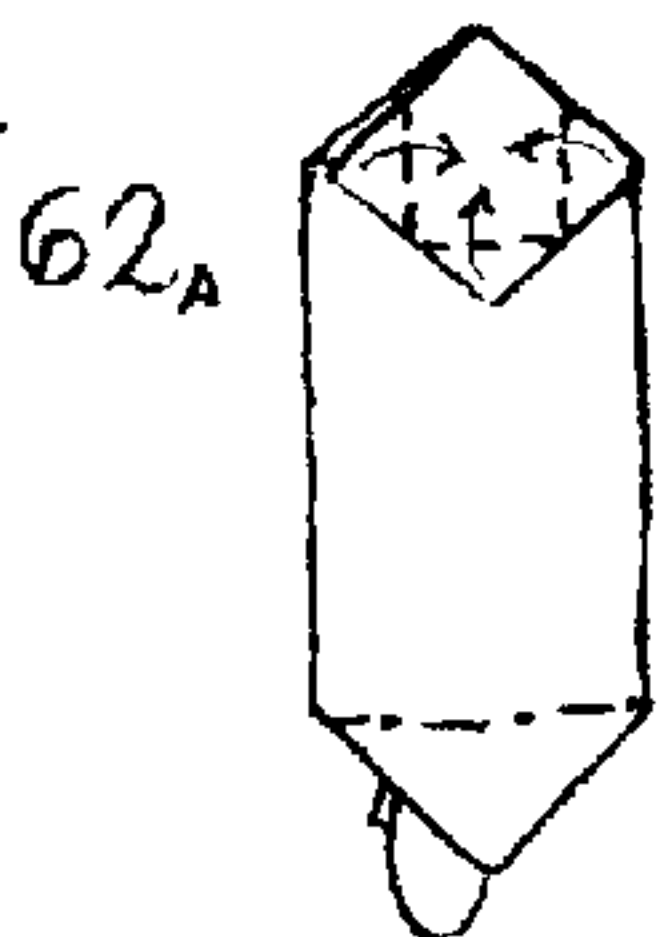
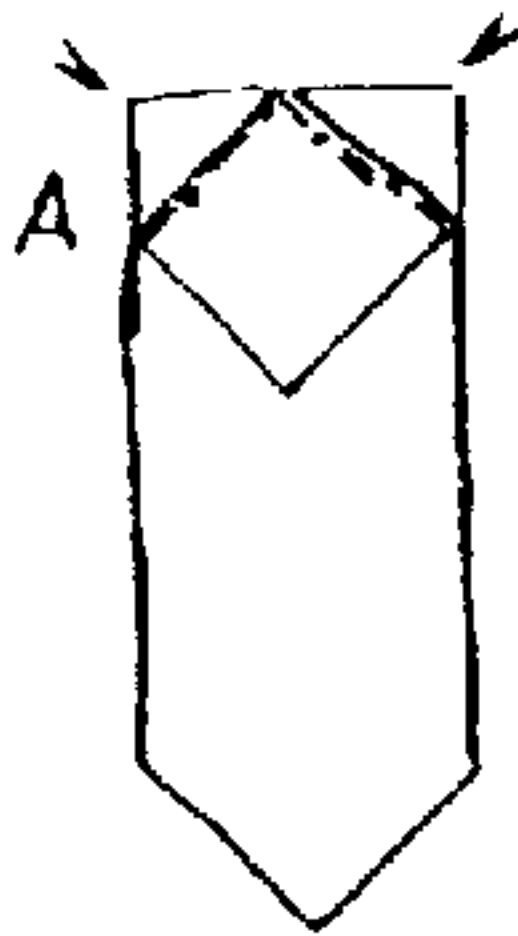
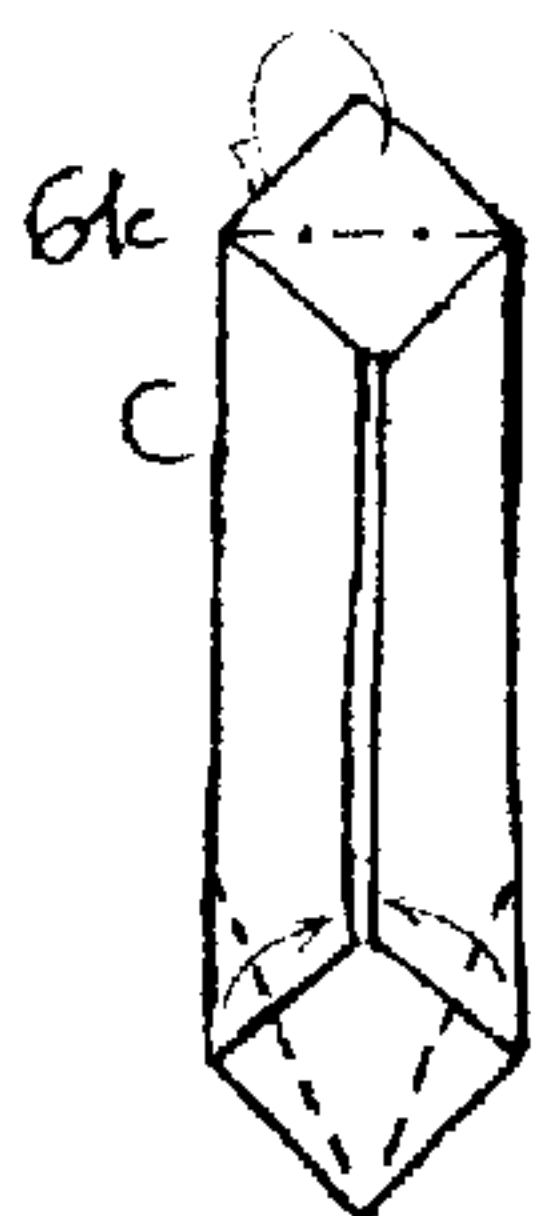
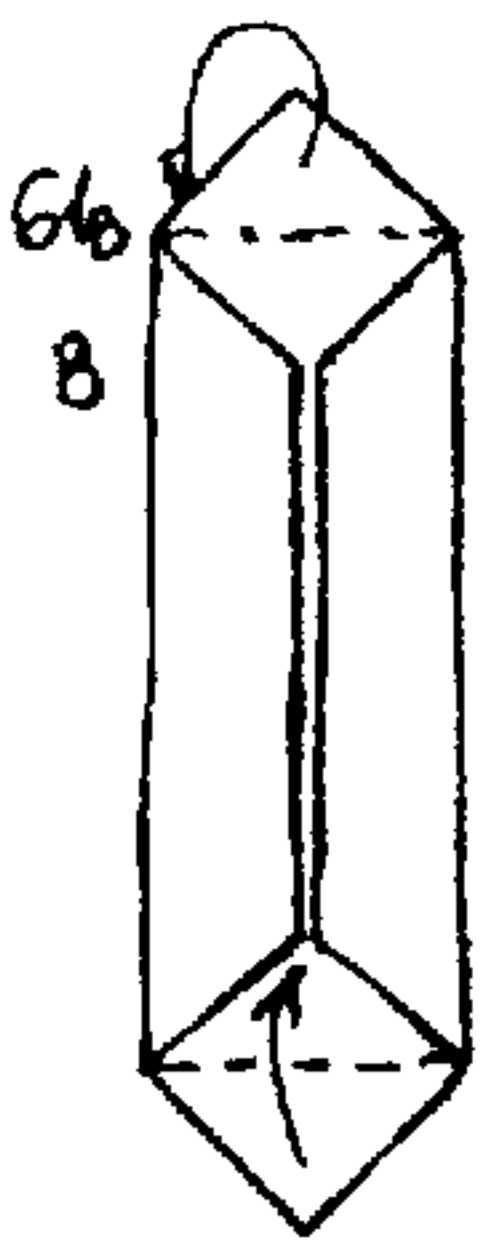
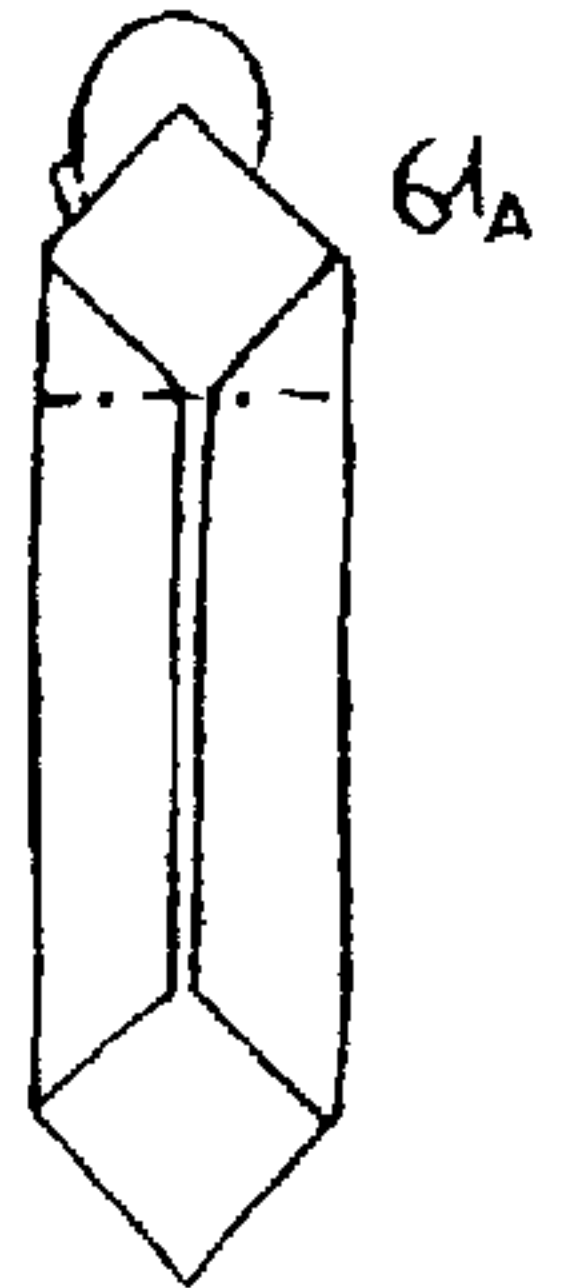
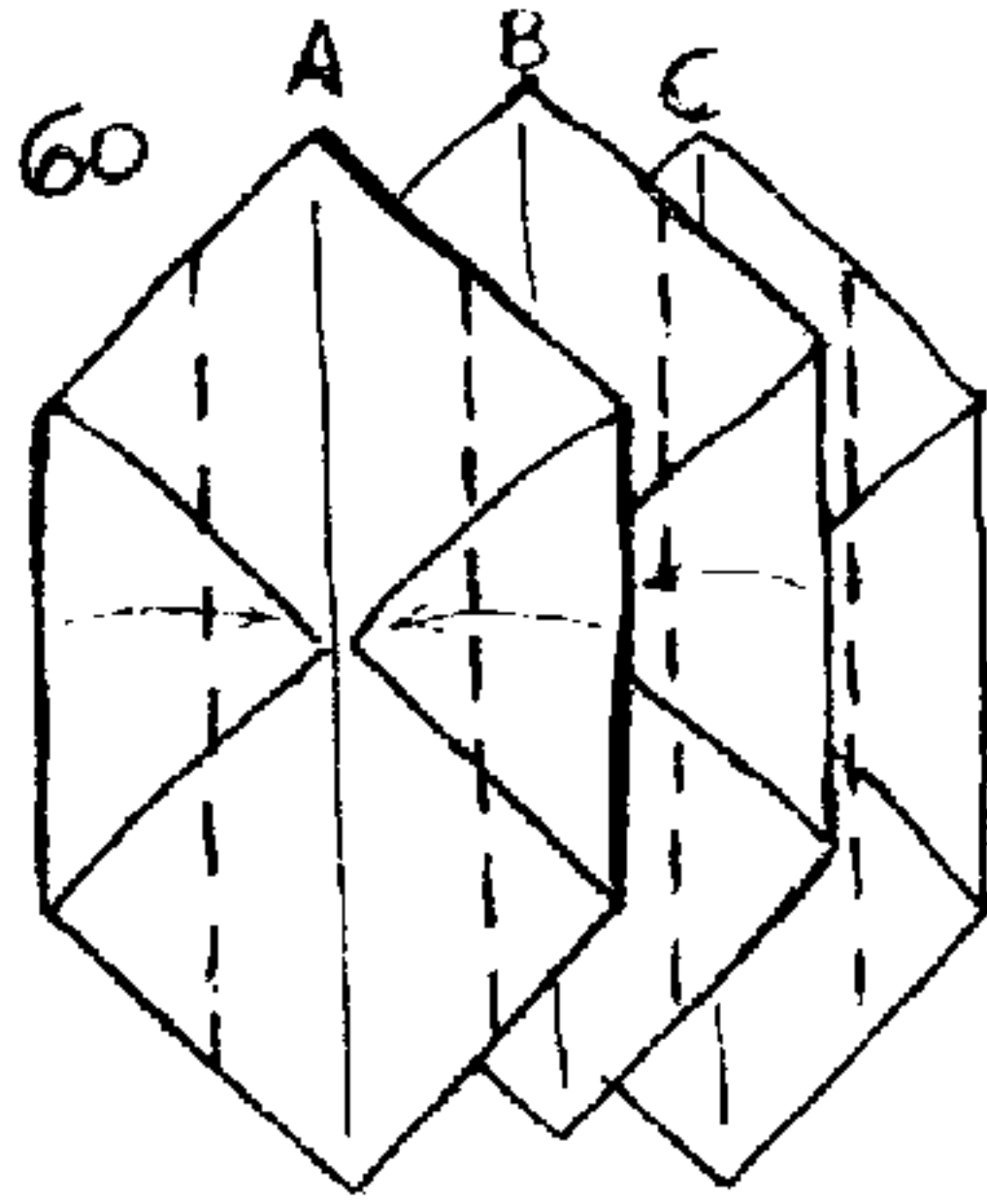

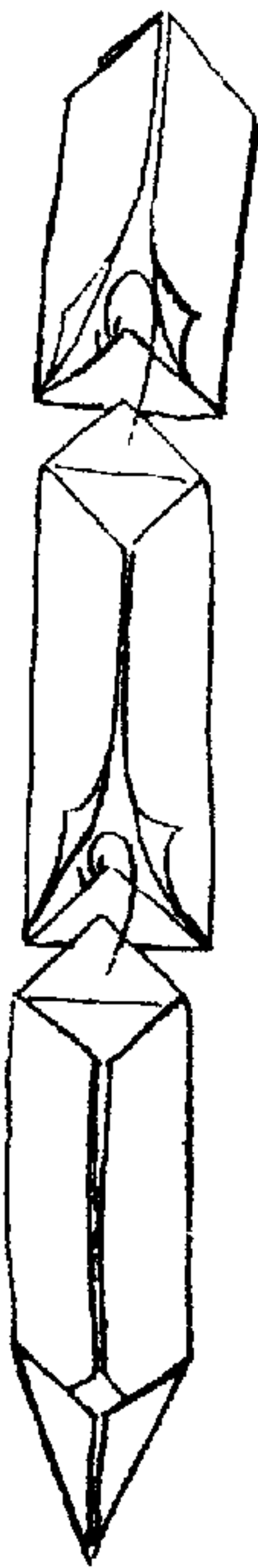
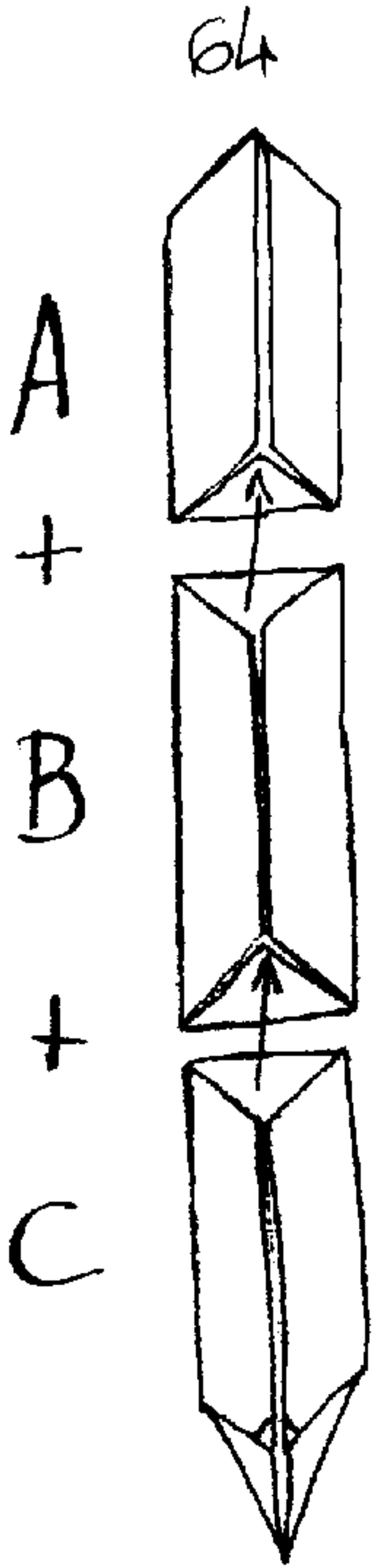

65

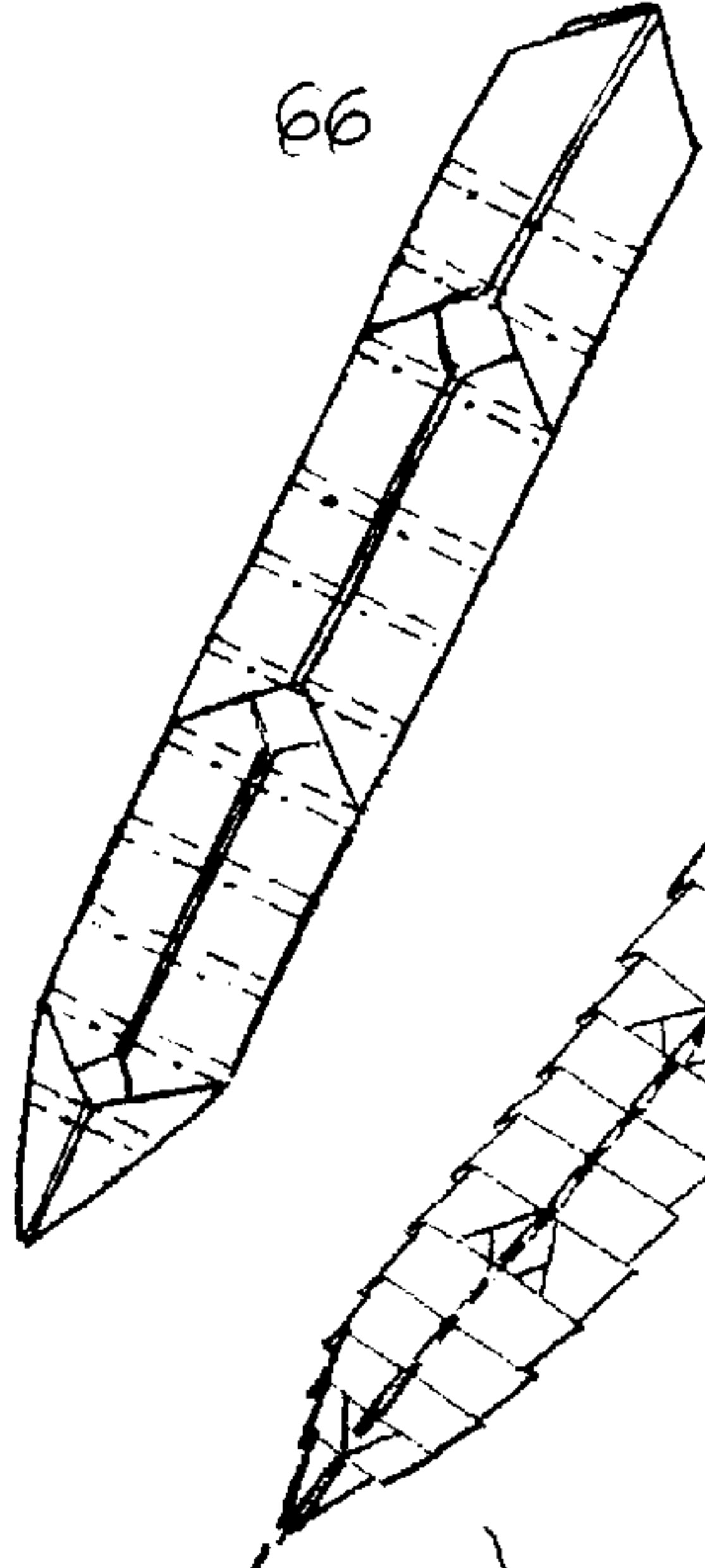

67

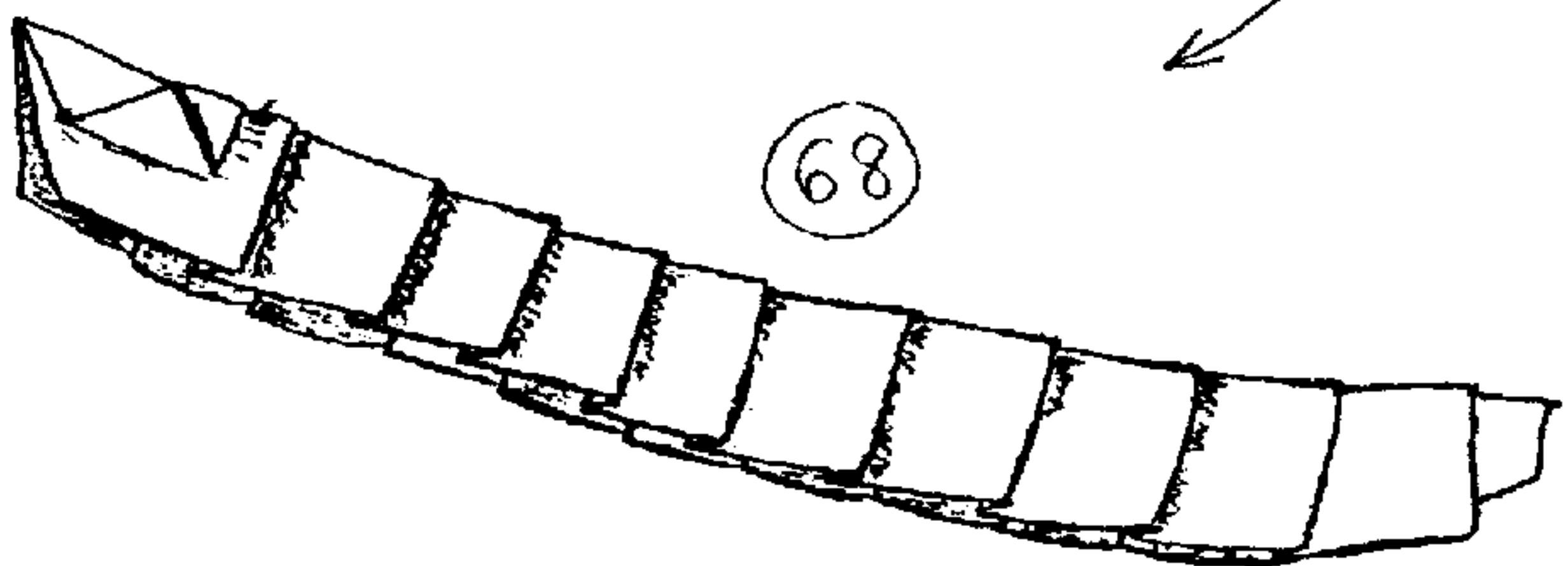

Uniones

CABEZA

Y CUELLO

69

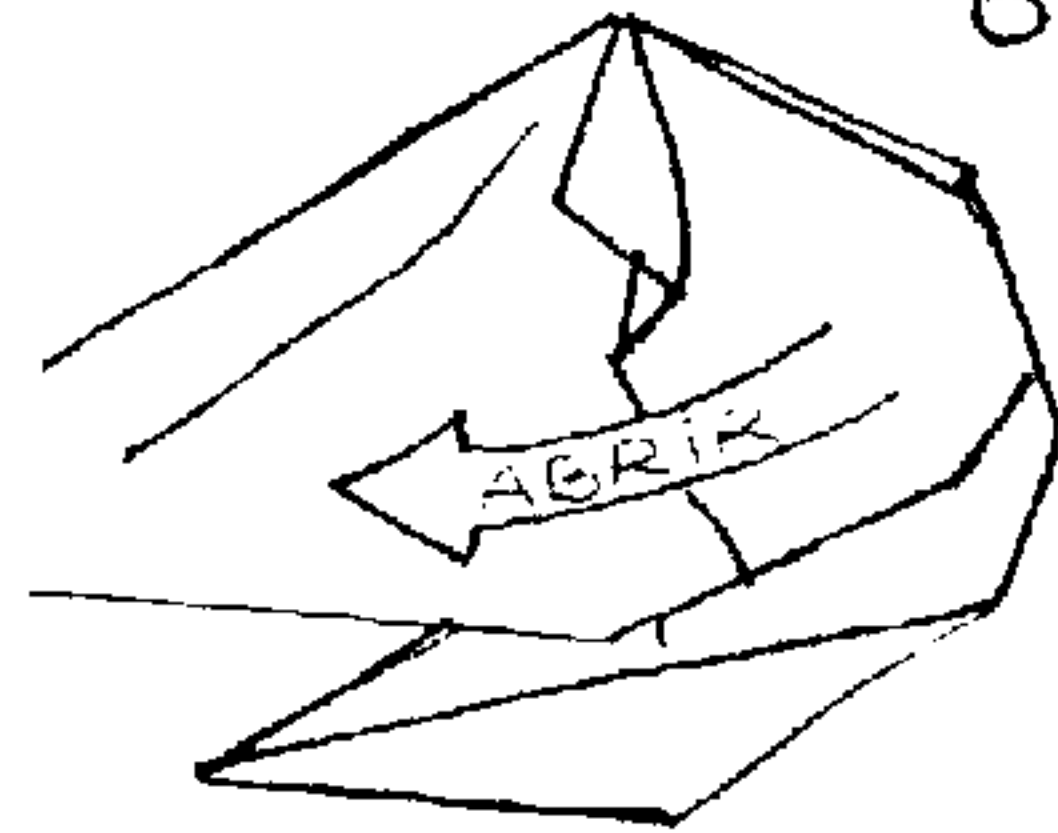

70

INTRODUCIR

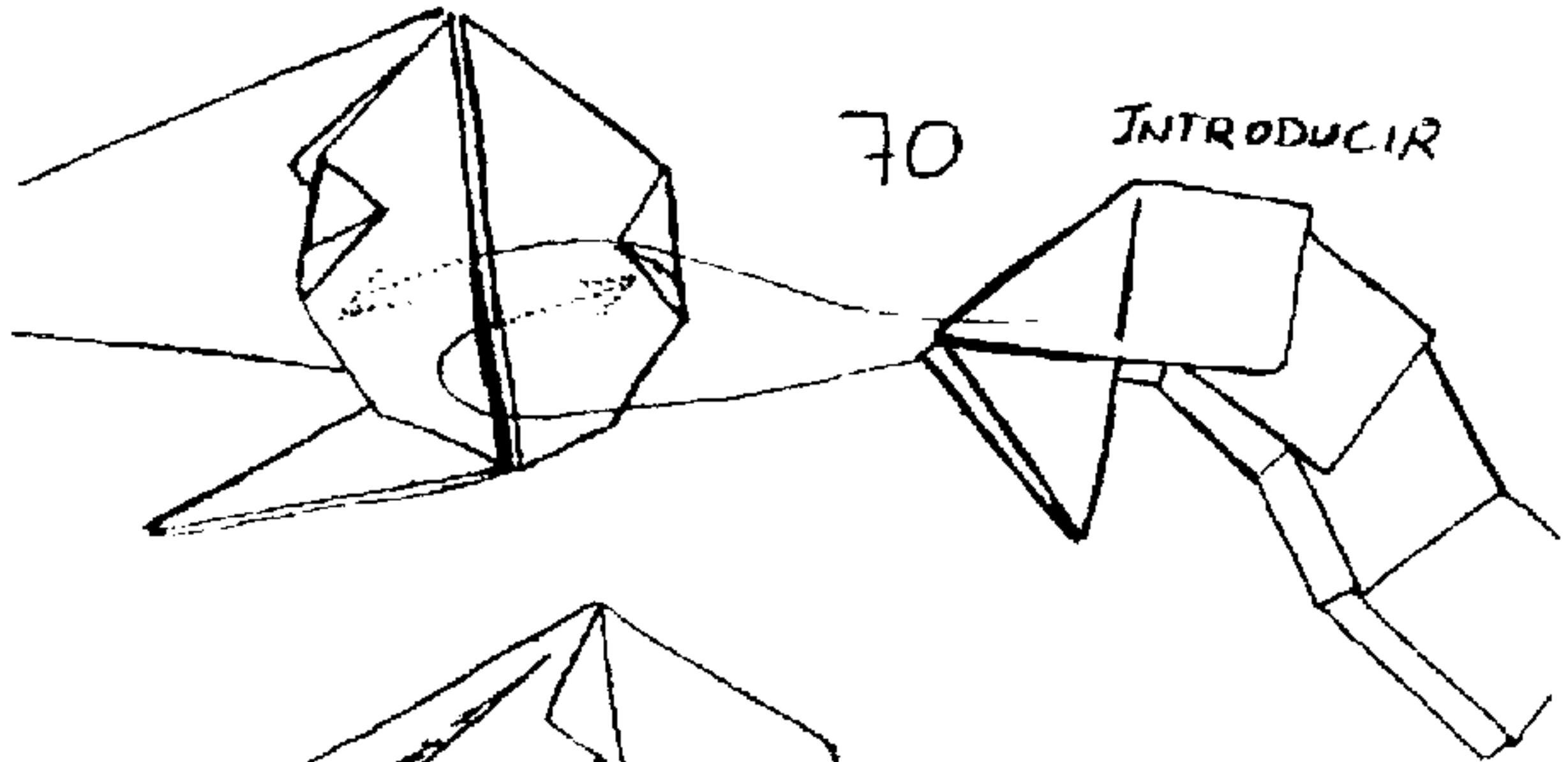

71

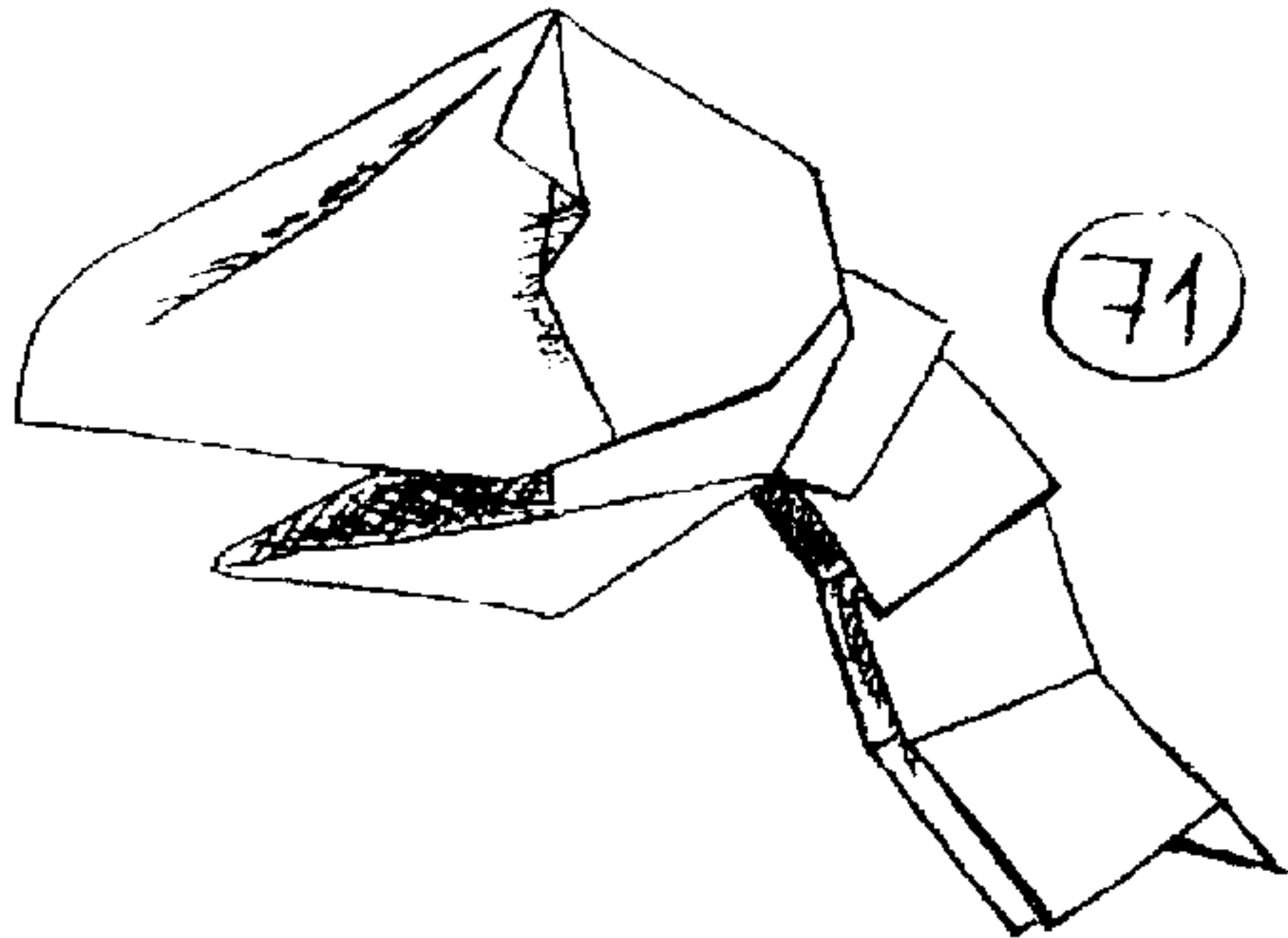

HOMBROS CON VÉRTEBRAS

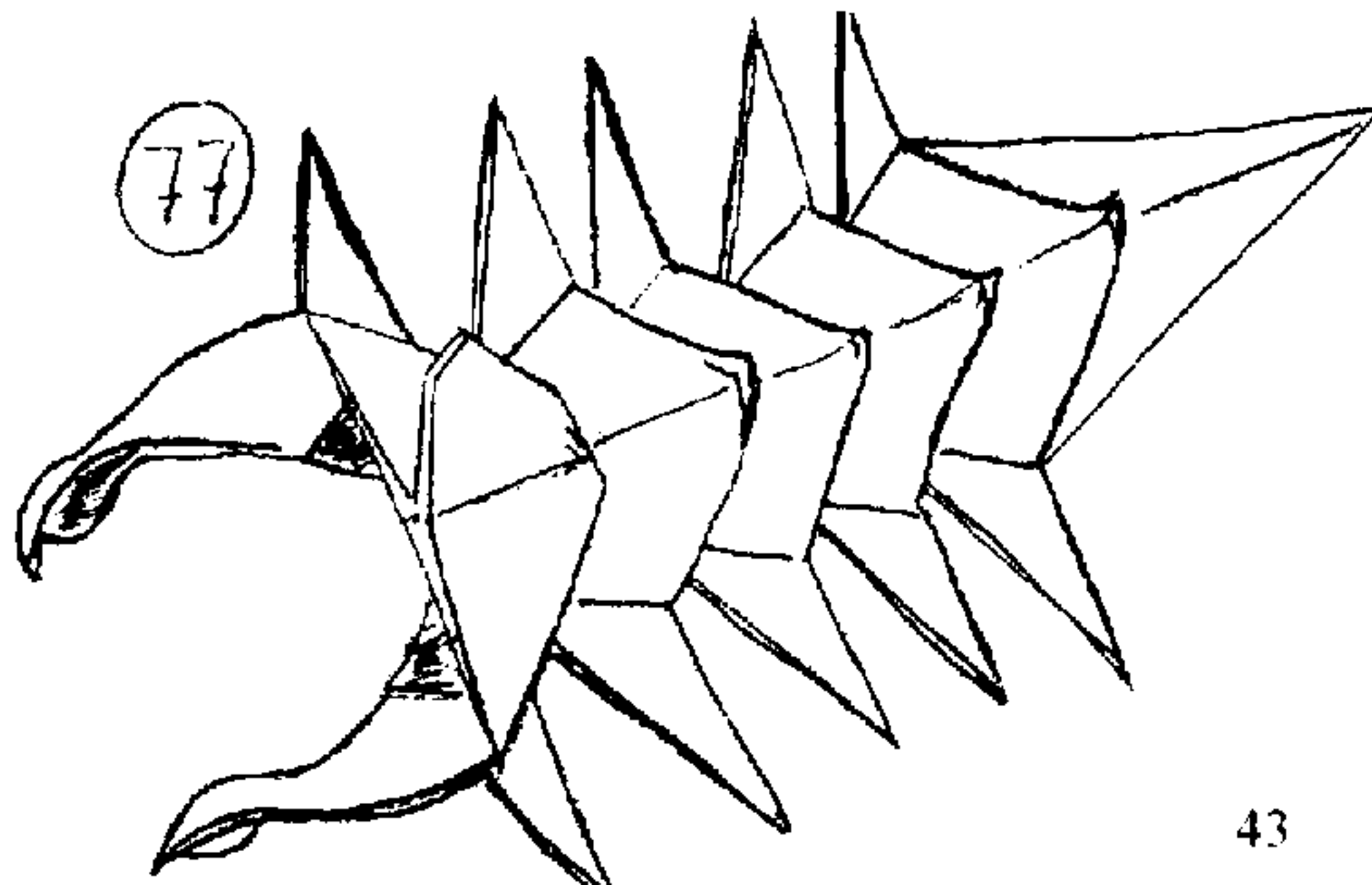
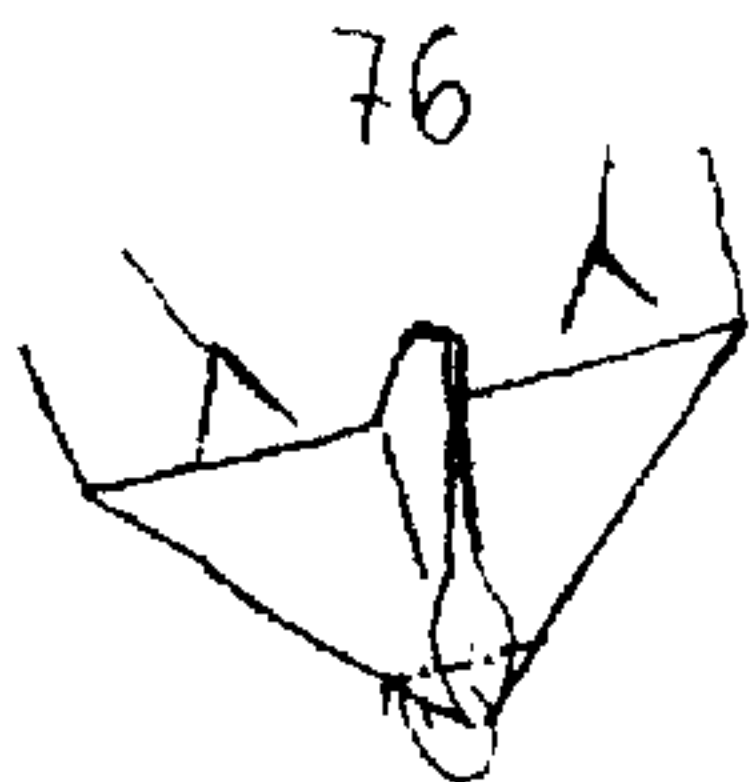
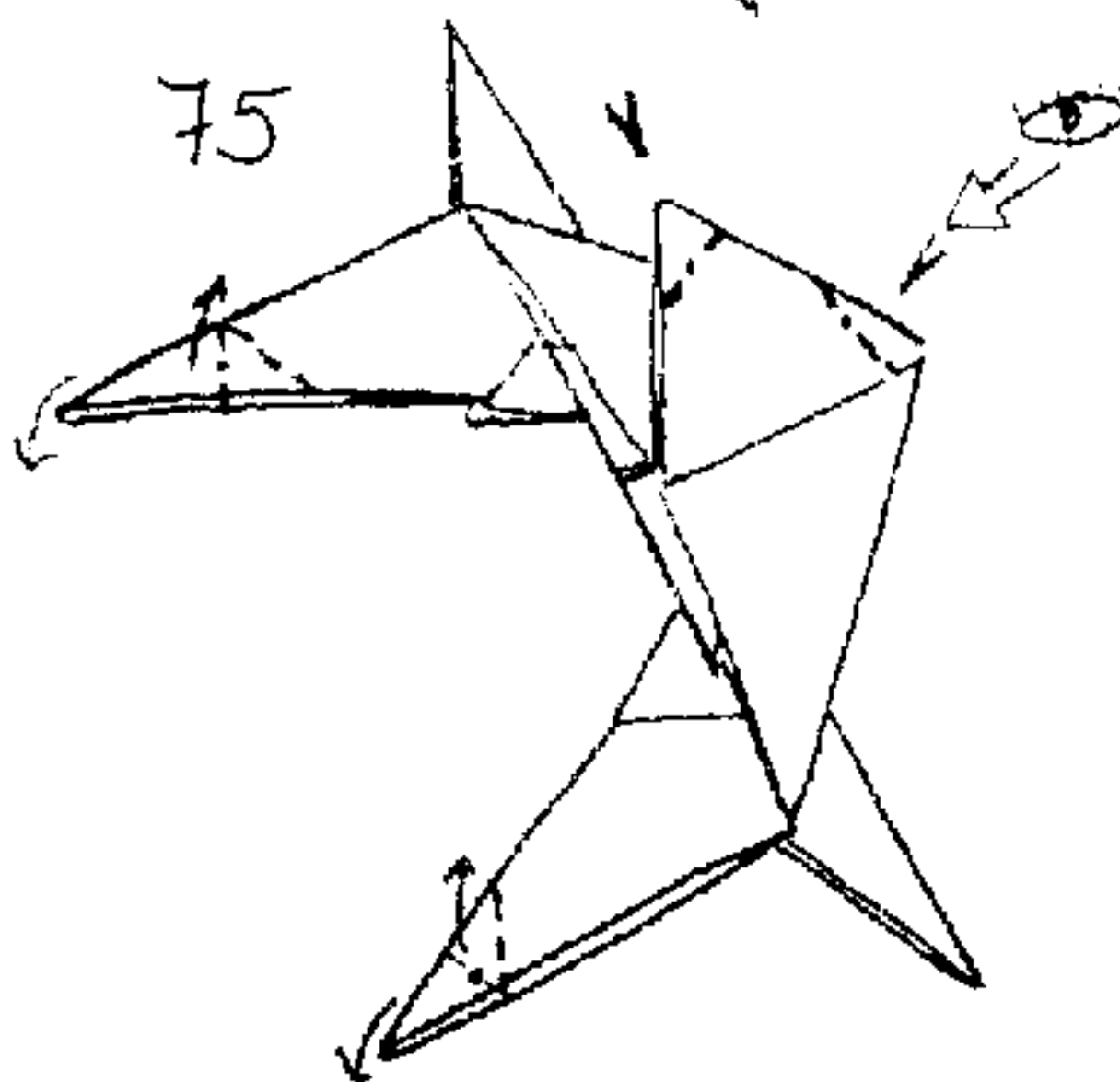
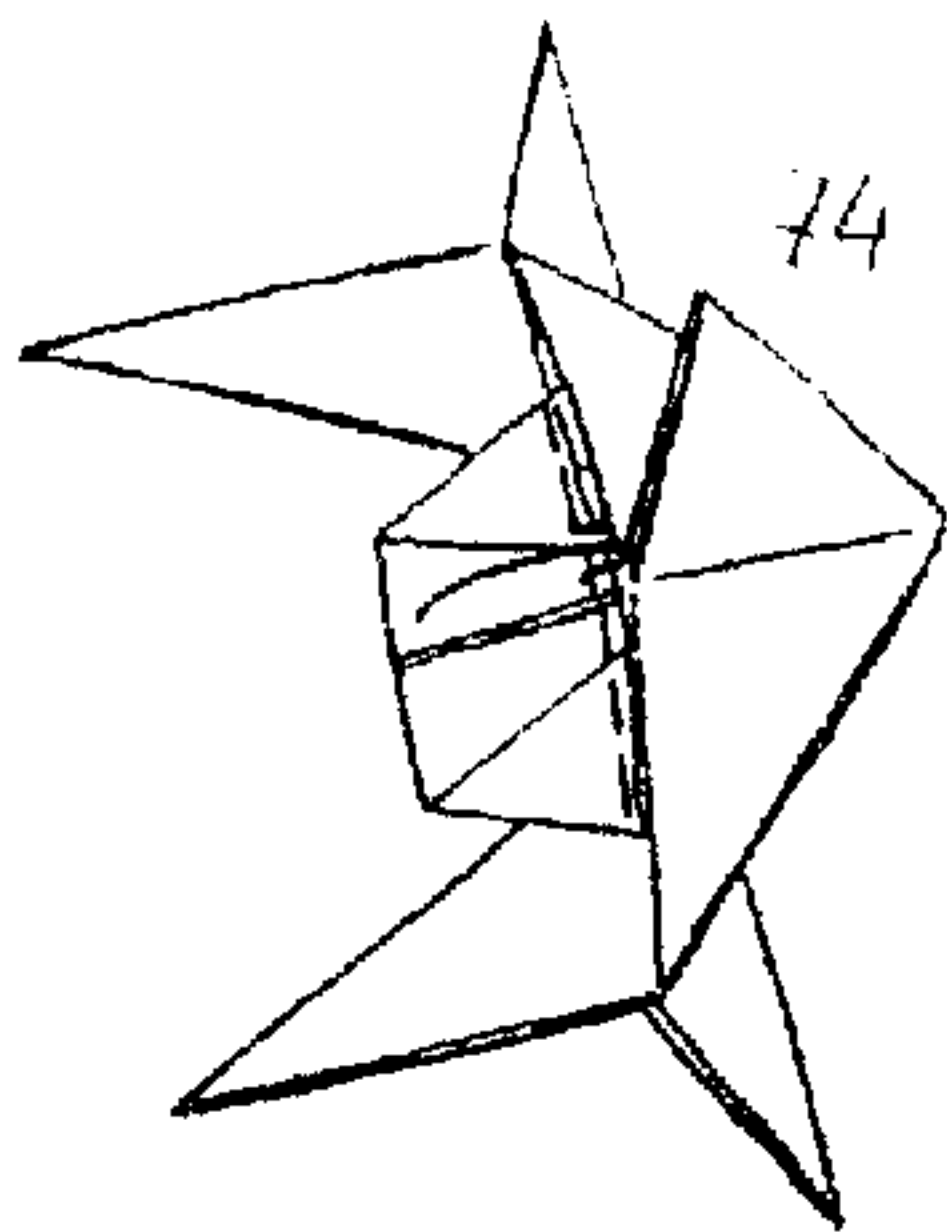
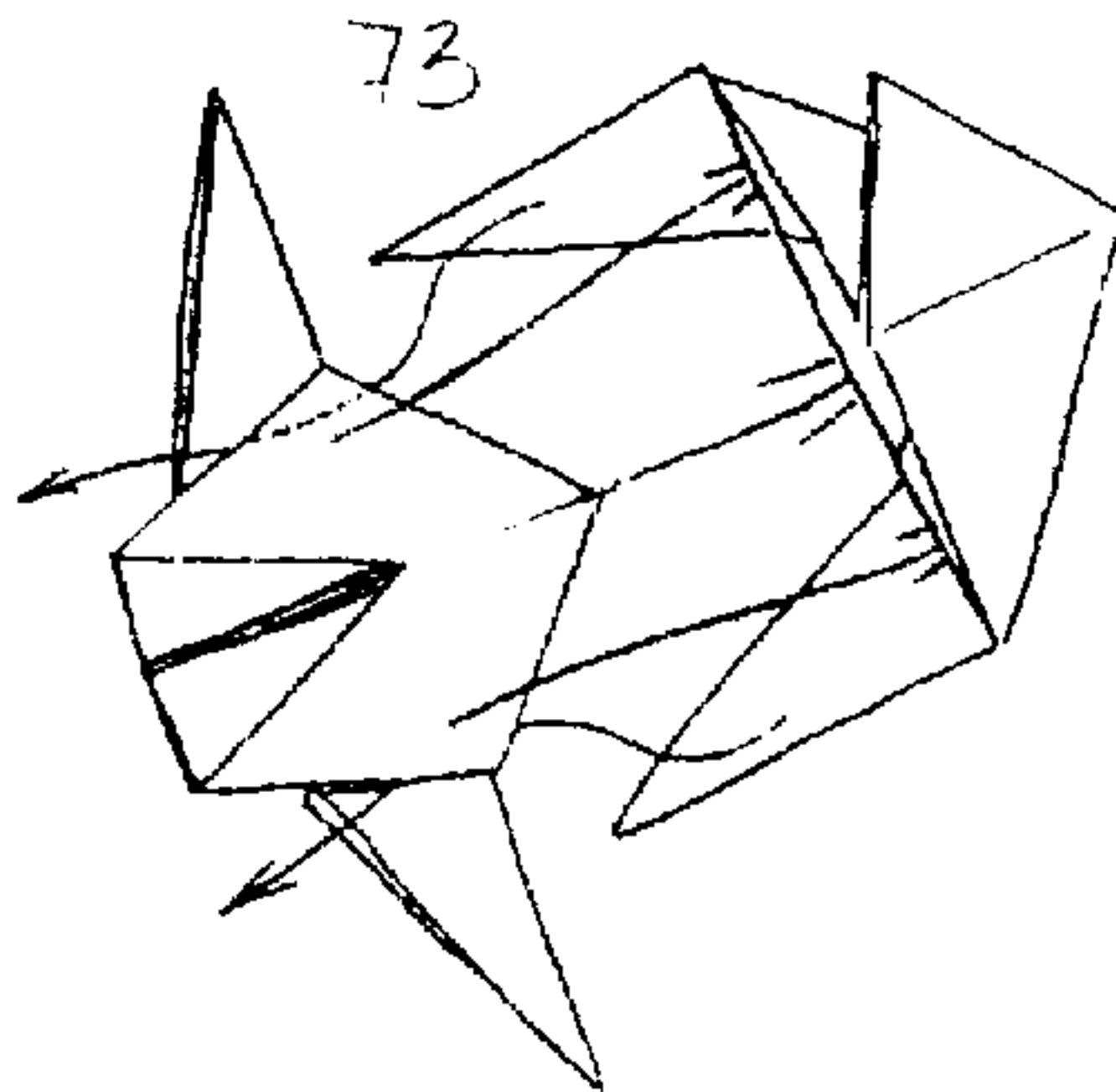
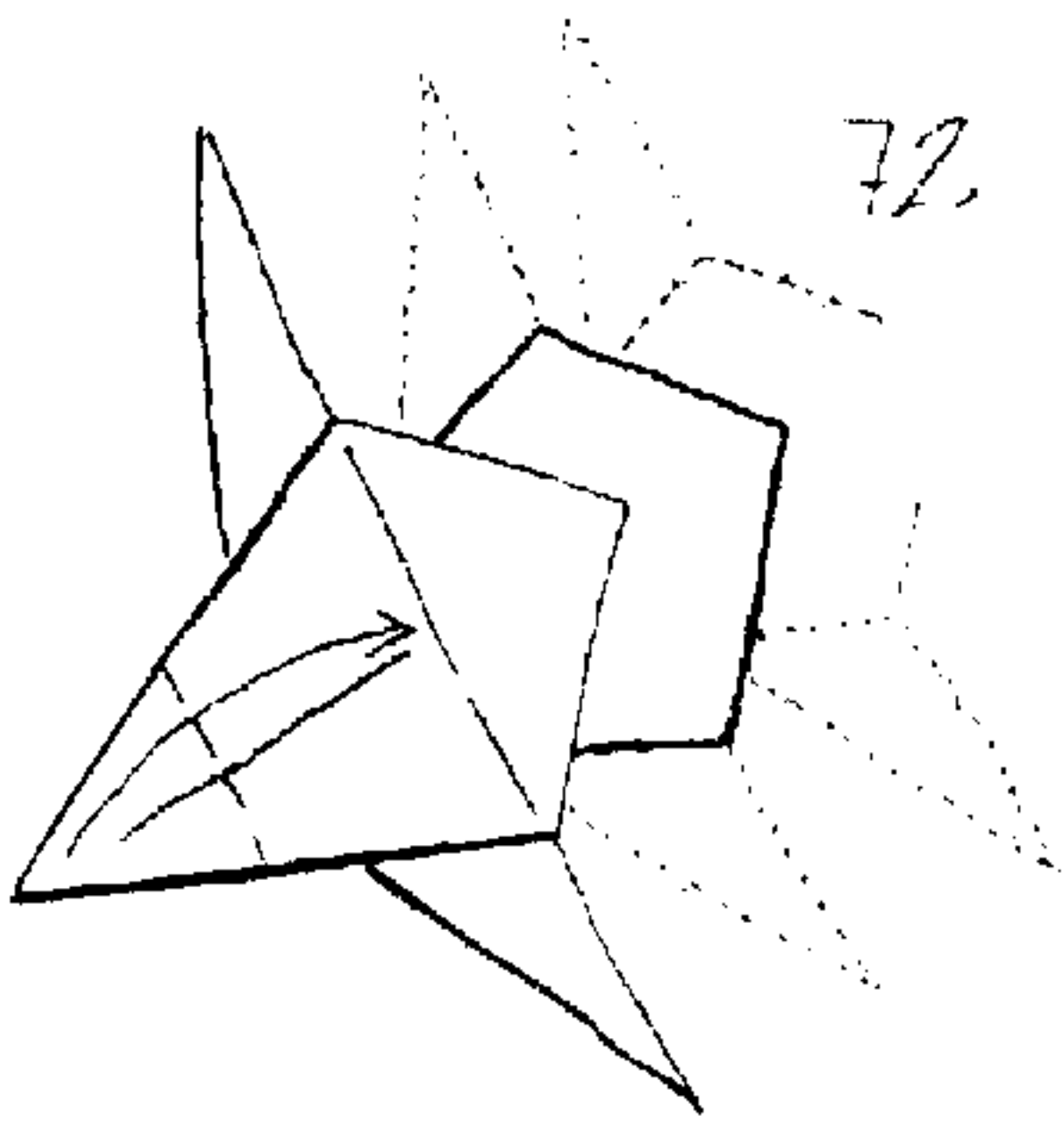

CUERPO Y COLA

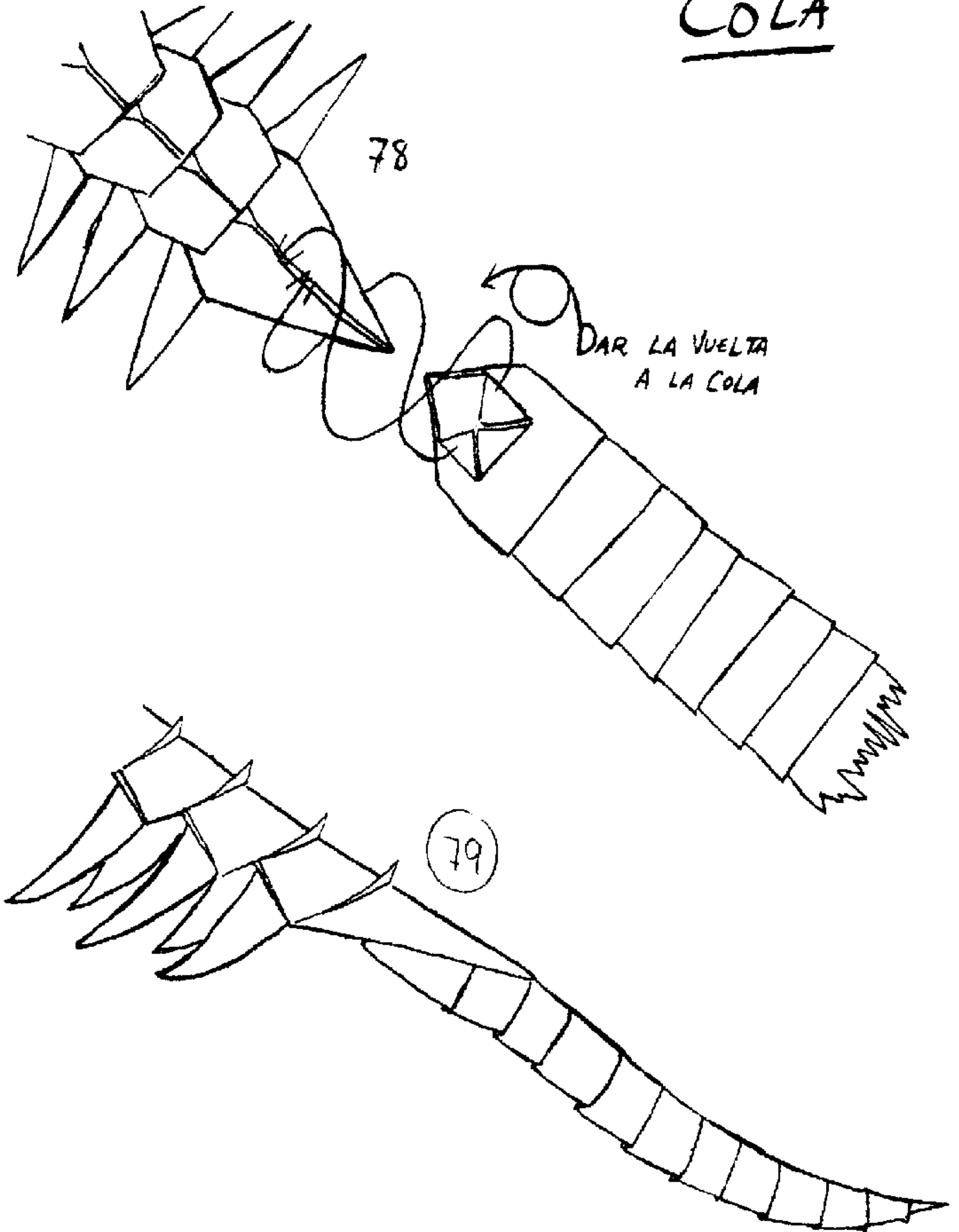

CUERPO Y

PATAS

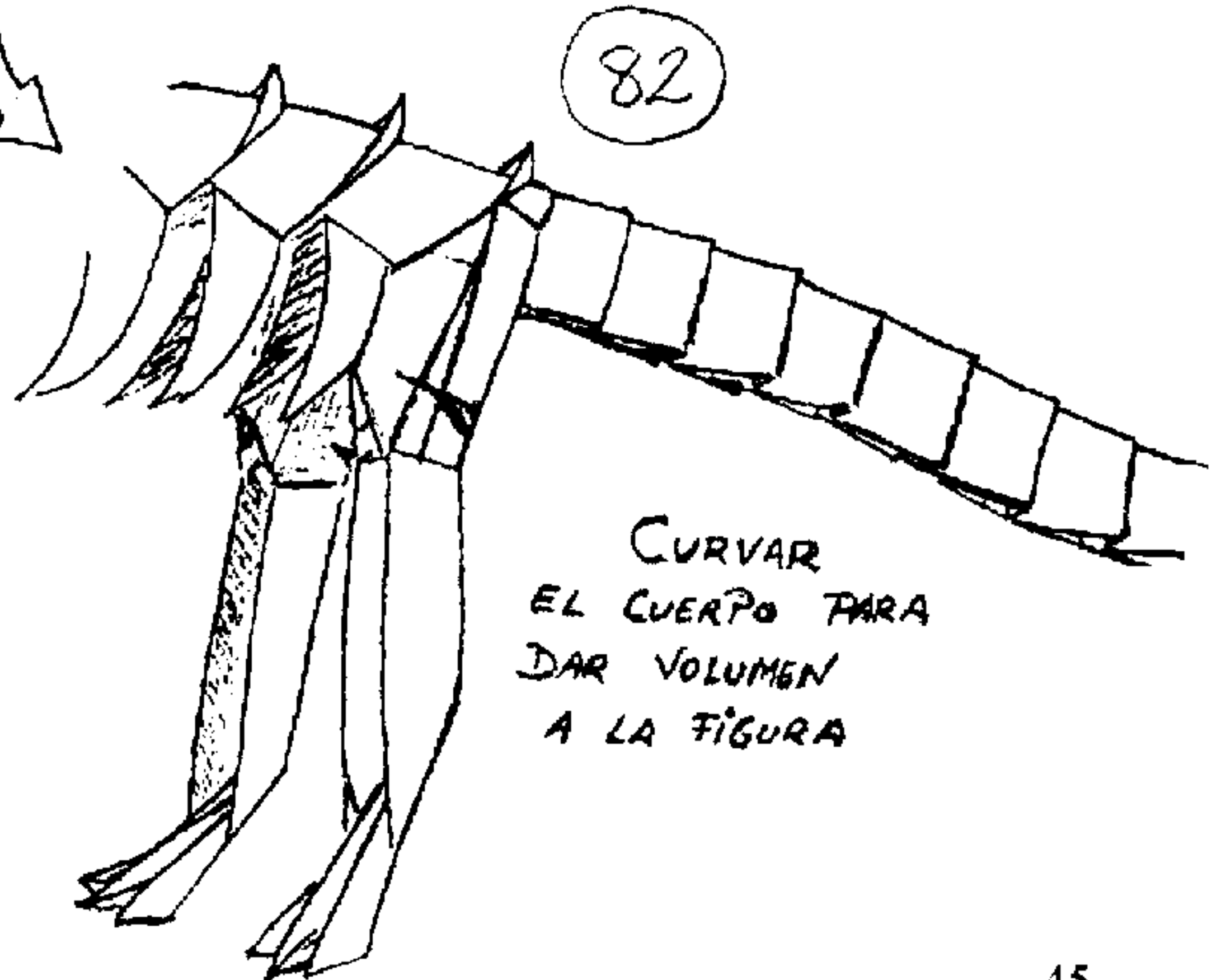
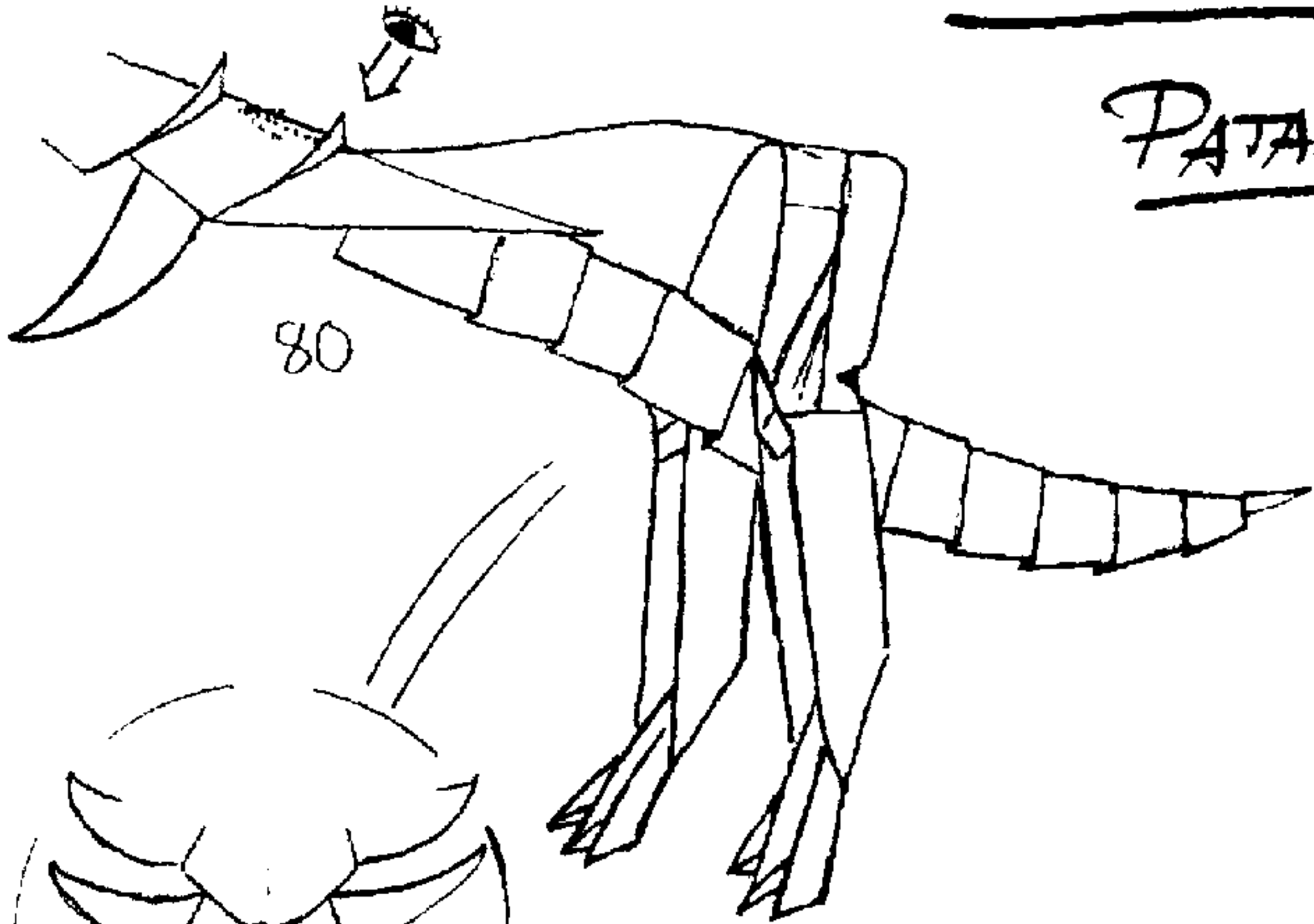

CURVAR
EL CUERPO PARA
DAR VOLUMEN
A LA FIGURA

CUELLO Y

HOMBROS

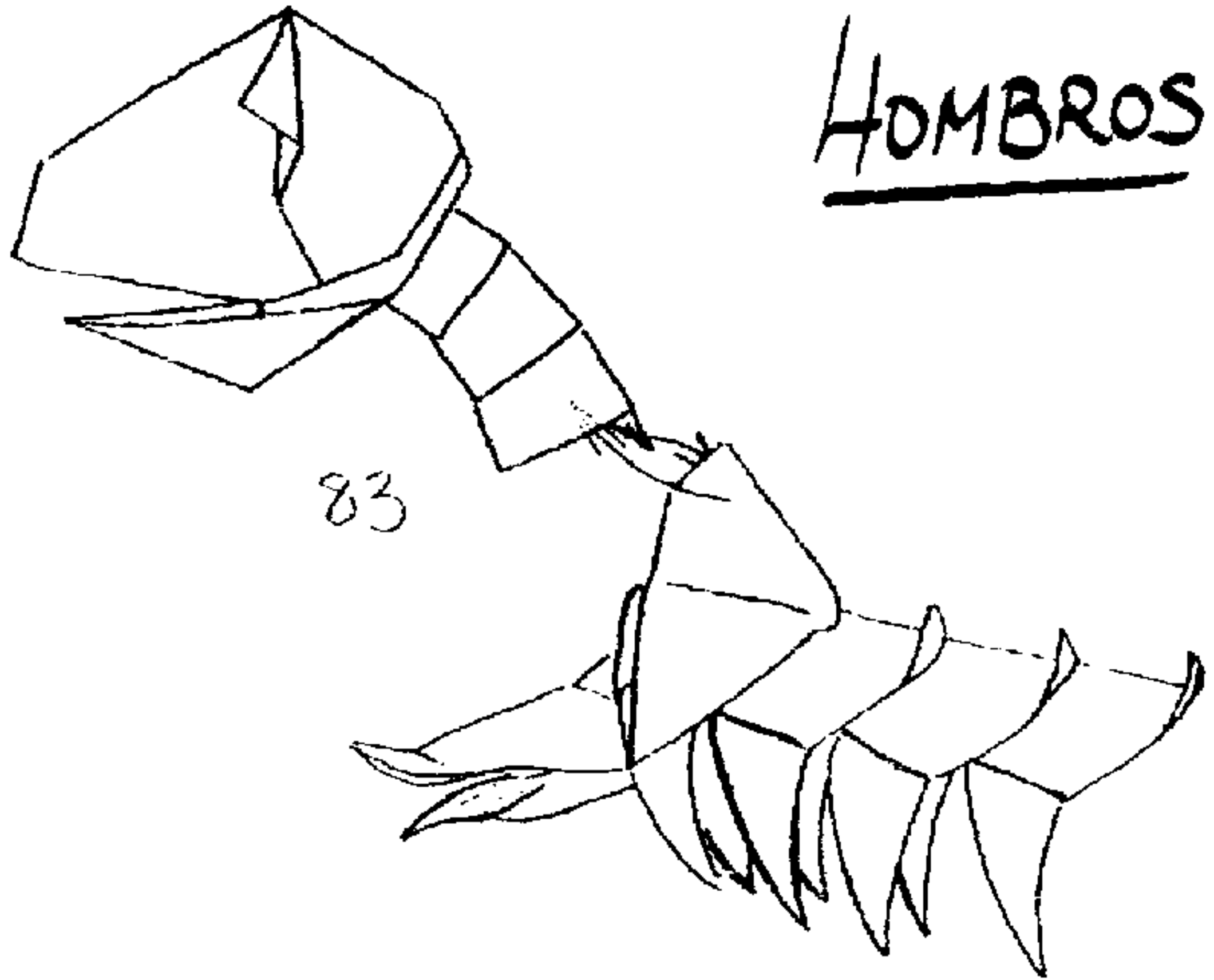

83

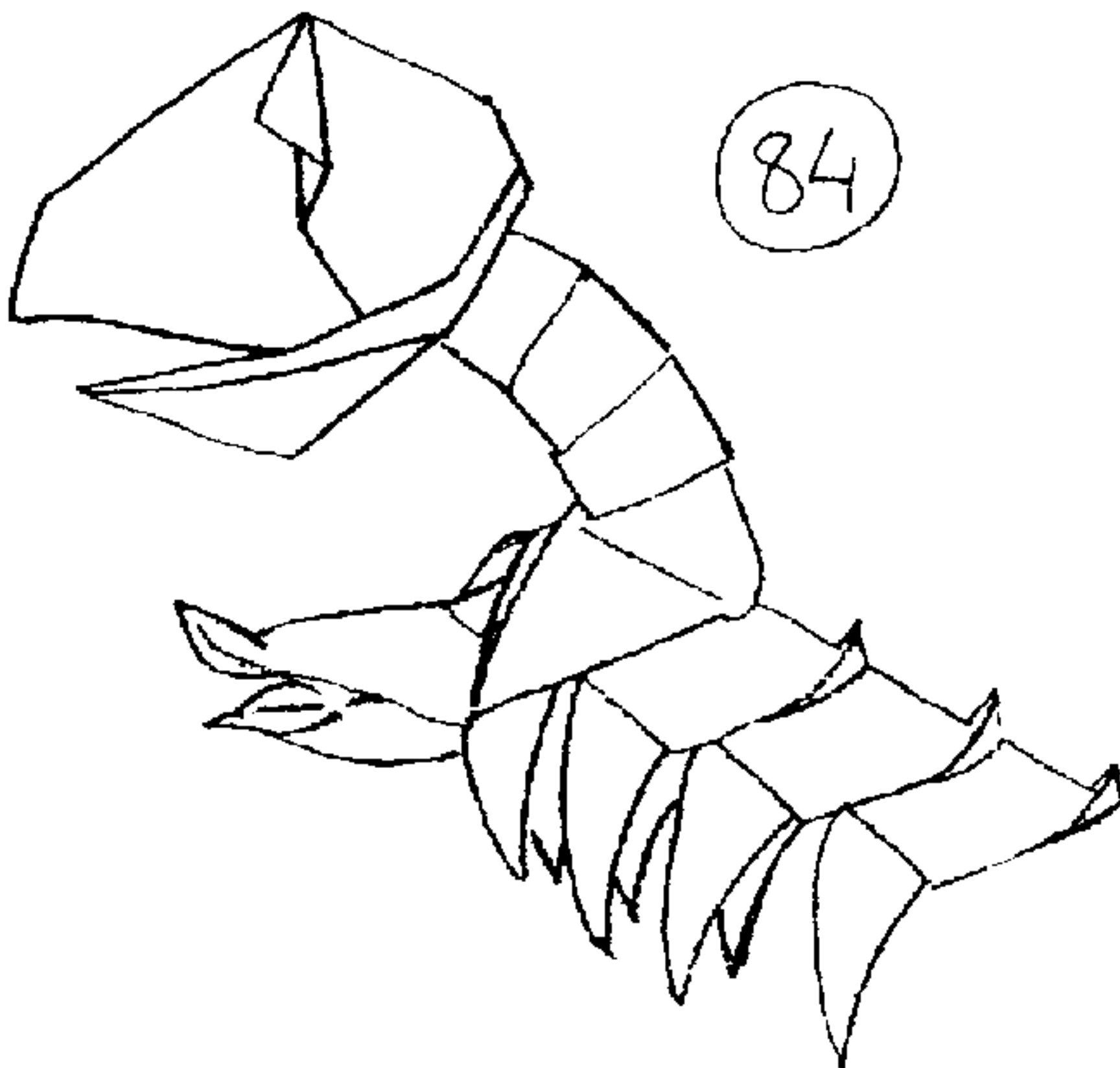

84