

暴龍

T. Rex

原作：zivchiu

畫圖：helliluya

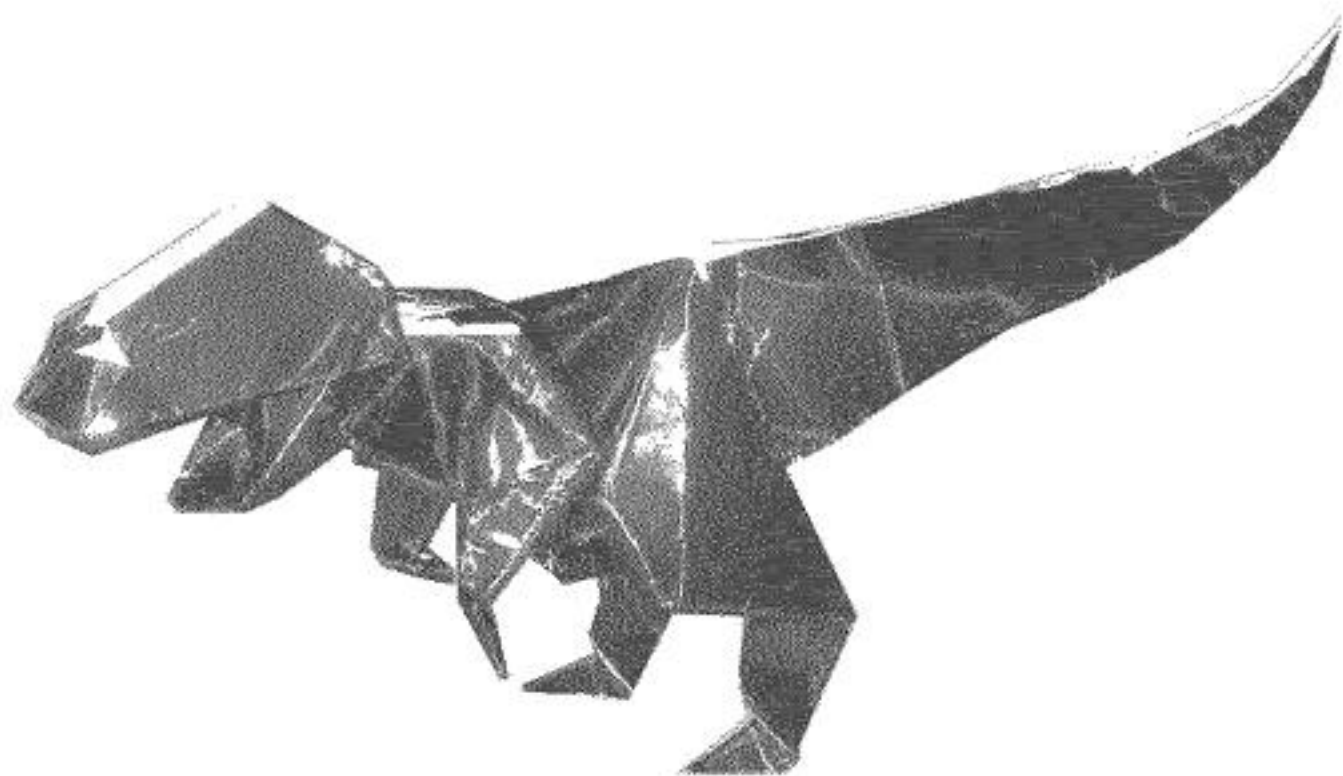

1

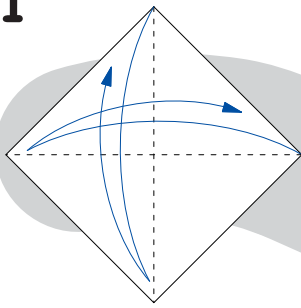

白色面向上，
沿著对角线摺线
White side up, fold
and unfold diagonals.

2

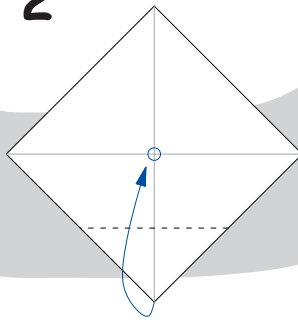

将一角摺到中心
Fold a corner to
the center.

3

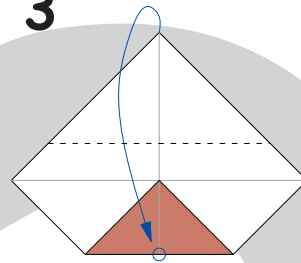

对摺到○处
Fold the corner to
the circled point.

4

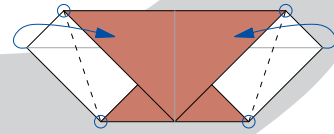

沿著○形成的线对摺进里面
Fold the corners up along
the line connecting
circled corners, and tuck
into upper layer.

6

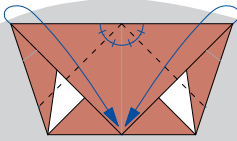

将两角摺至中心
Fold the corners to
the center.

5

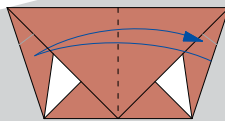

对摺再还原
Fold and unfold.

7

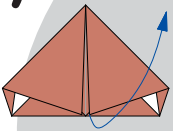

打开右边
Unfold right
corner.

8

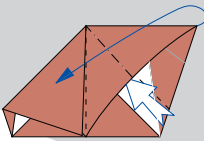

沉压摺至左边
Squash fold to
the left.

9

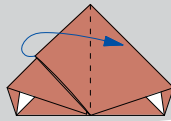

把一面摺至右边
Fold one edge to
the right.

10

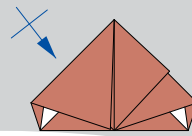

左边重覆 8-9
Repeat 8-9
on the left side.

11

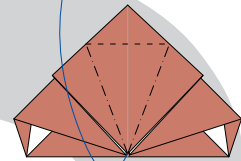

花瓣摺
Petal fold.

15

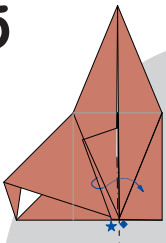

内翻摺至右边
Inside reverse fold
to the right.

14

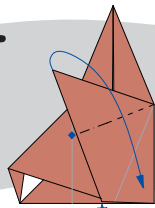

往下摺
Fold down the edge.

13

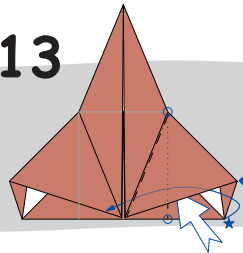

用既有线沉压
Squash fold using the
existing crease lines.

12

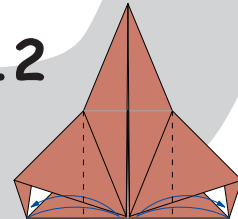

对摺再还原
Fold and Unfold.

16

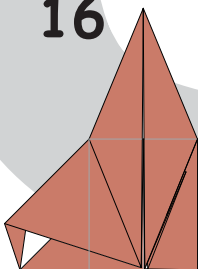

左边重覆 20-22
Repeat 20-22
on the left side.

17

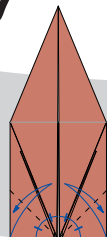

对摺再还原
Fold angle bisectors
and unfold.

18

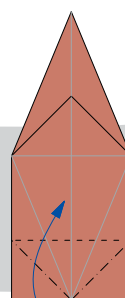

沉压至上方
Squash fold using the
existing crease lines.

19

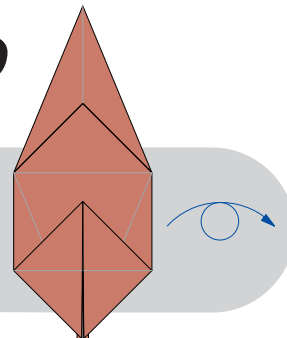

翻面
Turn paper over.

31

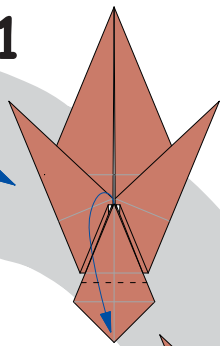

将最上层往下摺
Fold down top layer.

30

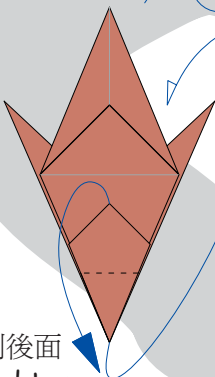

将最上层翻到後面
Fold down and turn
the layer over.

29

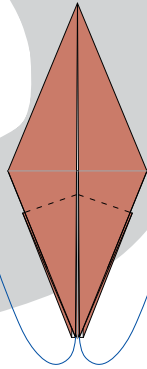

往上摺
Fold the edges up.

32

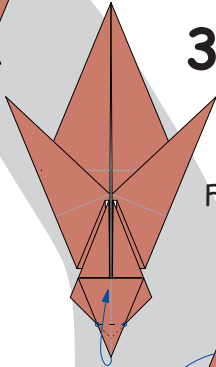

往上摺
Fold the edge up.

33

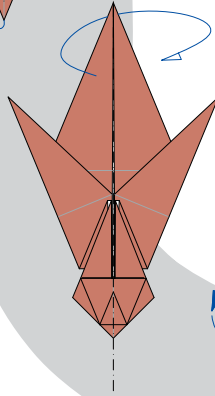

对摺
Fold the model
in half.

35

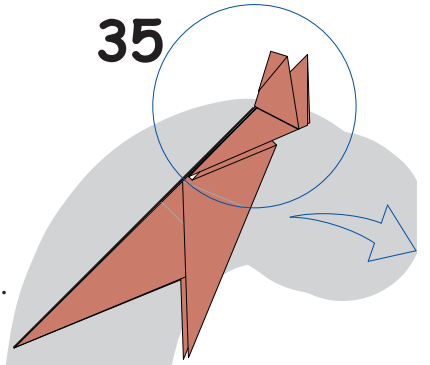

以下放大
Magnified view.

34

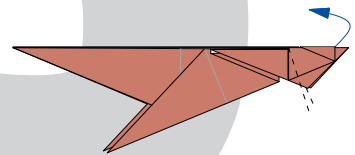

将最上层往上拉
Pull out the top
layers on both sides .

28

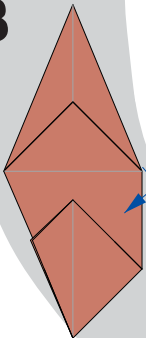

右边重覆 XX-XX
Repeat XX-XX
on the left side.

27

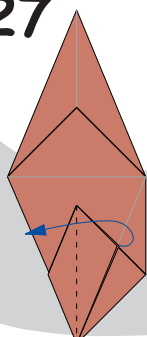

往左摺一层
Fold one edge
to the left.

26

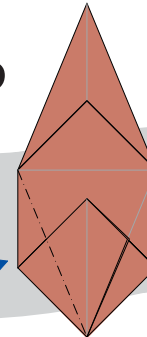

左边沉摺
Open sink the
left edge.

25

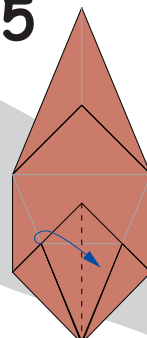

往右摺一层
Fold one edge
to the right.

24

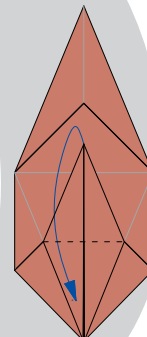

往下摺
Fold the edge down.

20

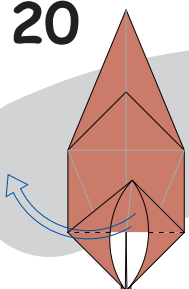

把在里面的纸拉出来
Pull out lower part
of the model.

21

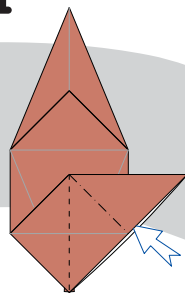

沉压摺
Squash fold .

22

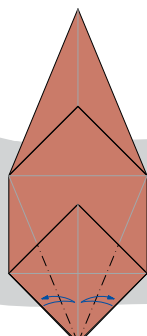

对摺再还原
Fold and Unfold.

23

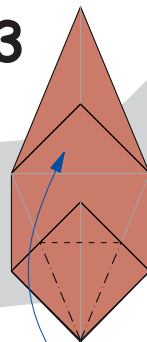

花瓣摺
Petal fold.

36

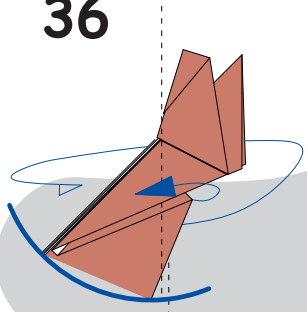

里面一层翻摺
Inside reverse fold.

37

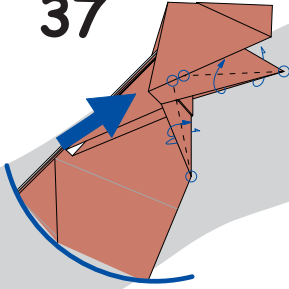

里面翻摺，并将箭头处
压进里面
Inside reverse fold
and tuck the edge in.

38

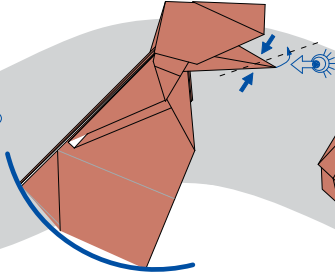

将侧边摺入
Fold the side
edge in.

39

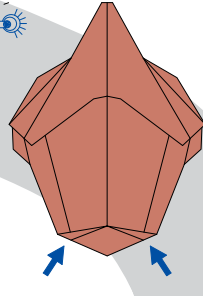

由内侧压平并翻摺
Inside reverse fold
and flatten the model.

40

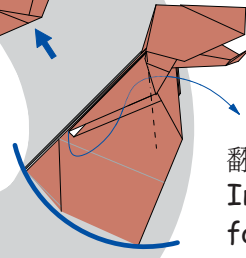

翻摺至右边
Inside reverse
fold the edge
to the right.

41

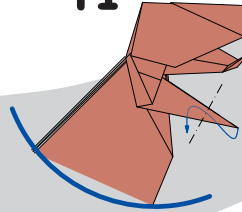

往下翻摺
Inside reverse fold.

42

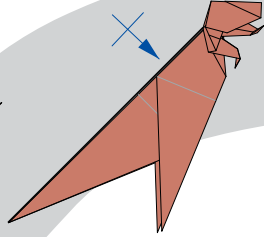

另一边重覆 40-41
Repeat 40-41
on the other side.

43

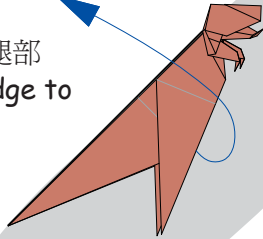

往左边打开腿部
Open the edge to
the left.

44

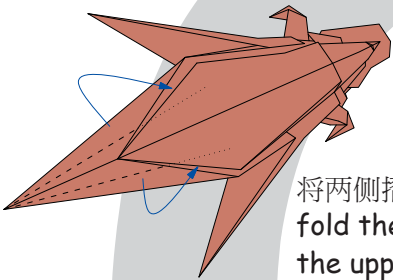

将两侧摺进上一层
fold the edges to
the upper layer.

45

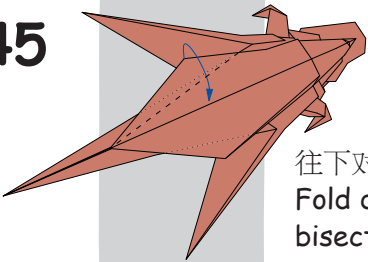

往下对摺
Fold down the angle
bisector.

46

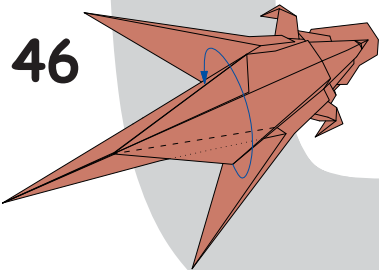

往上对摺至另一缝隙中
Fold the angle bisector
and tuck it into upper
pocket.

47

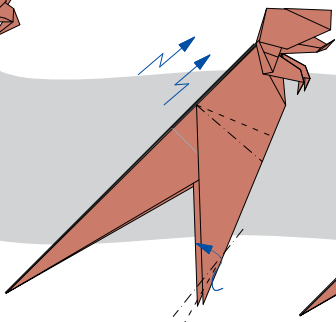

两侧段摺 并翻摺下方至左边
Pleat on both sides at
the same time and inside reverse
fold the edge to the left.

翻摺至右边
Inside reverse fold
the edge to the right.

48

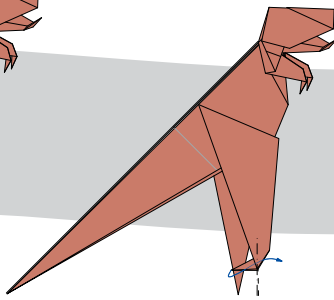

另一边重覆 47-48
Repeat 47-48
on the other side.

49

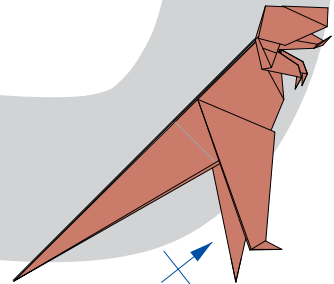

完成
Model completed.

