

RINOCERONTE

1 

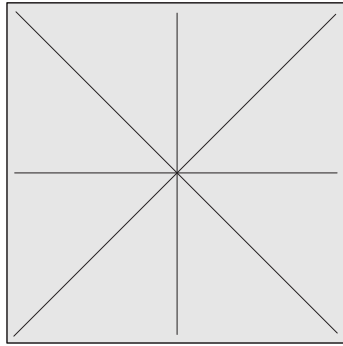

2 Repetir en las cuatro esquinas

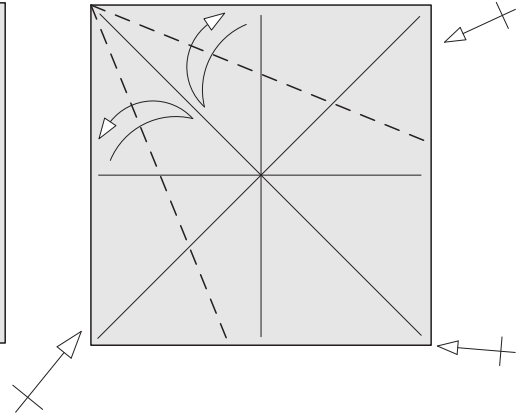

3

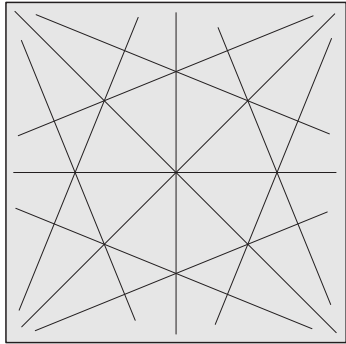

4

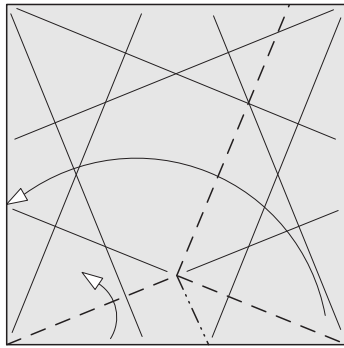

5

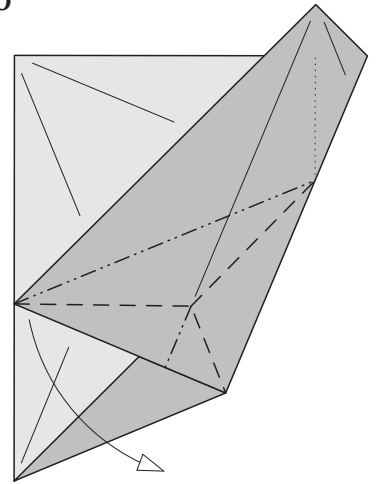

6 Repetir a la izquierda los pasos 4 y 5

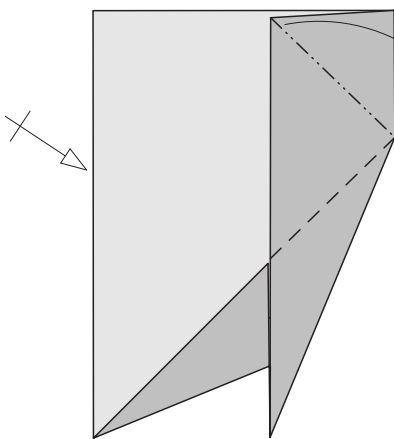

7

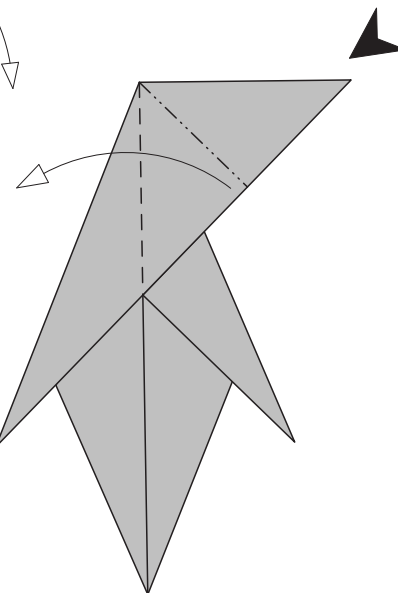

8

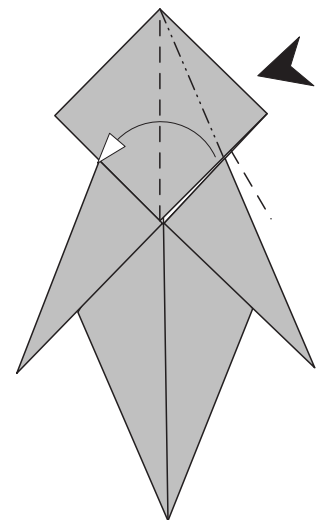

9

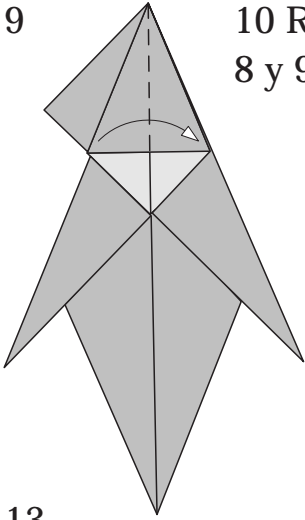

10 Repetir
8 y 9

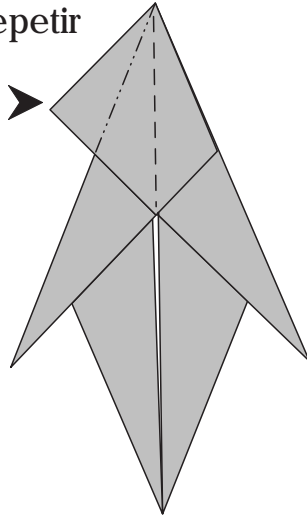

11

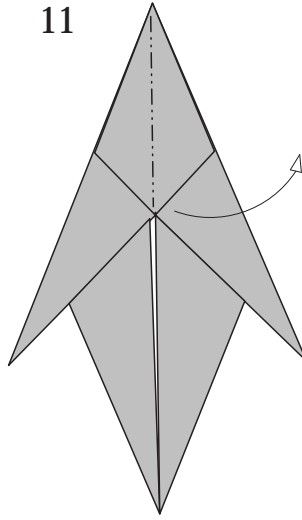

12

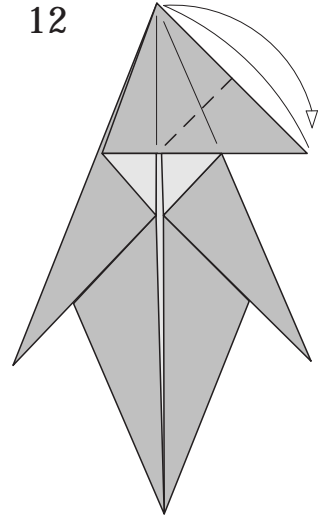

13

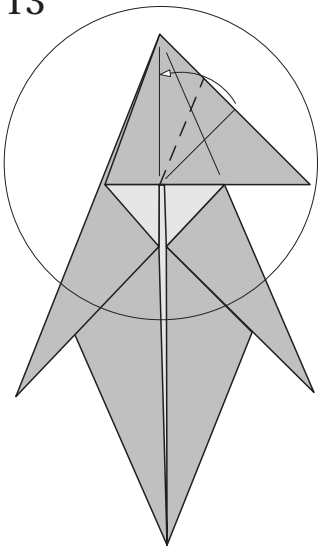

14

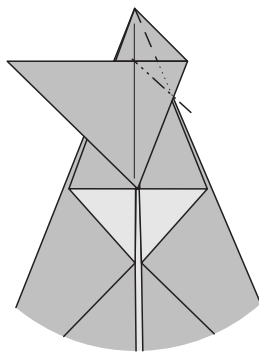

15

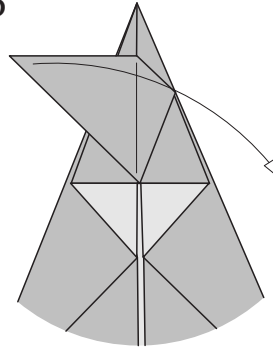

16

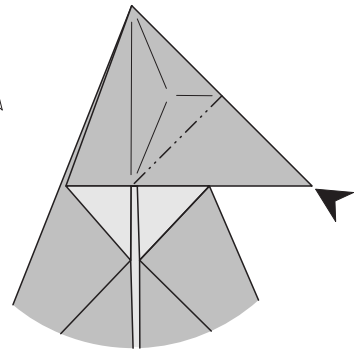

17

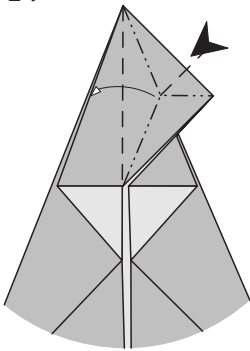

18

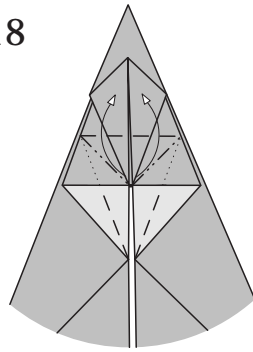

19

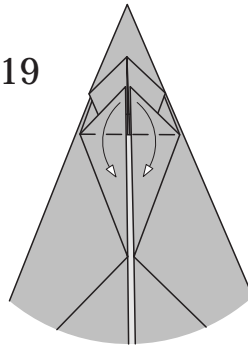

20

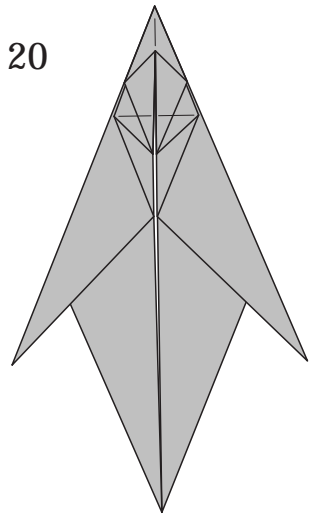

21

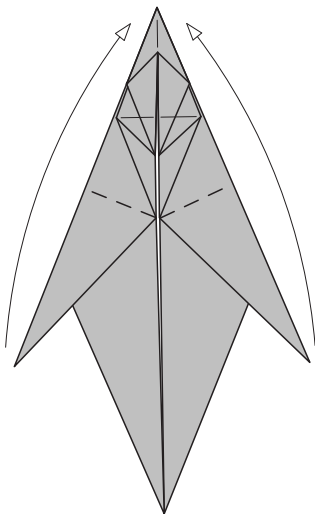

22

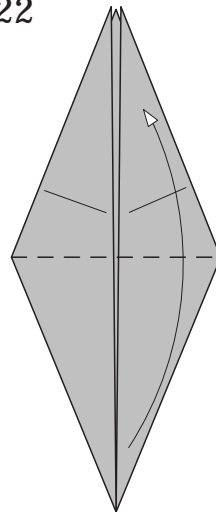

23

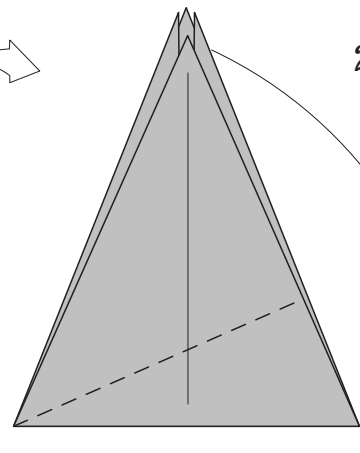

24

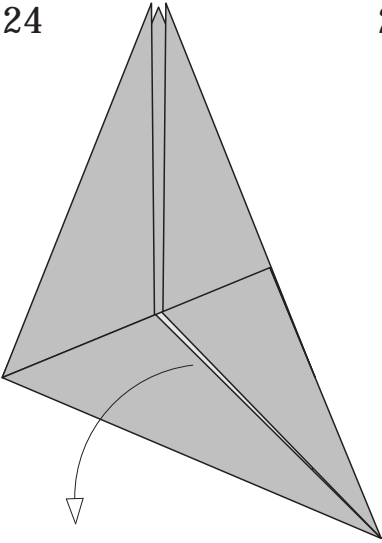

25

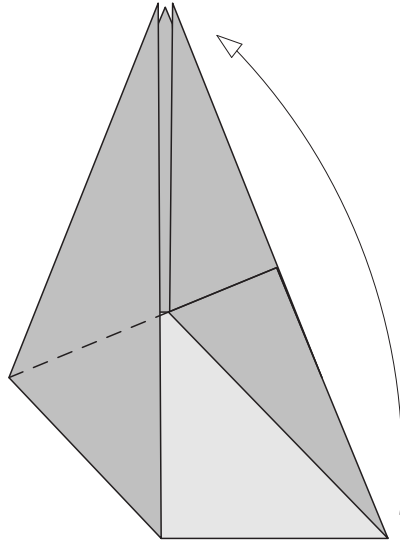

26

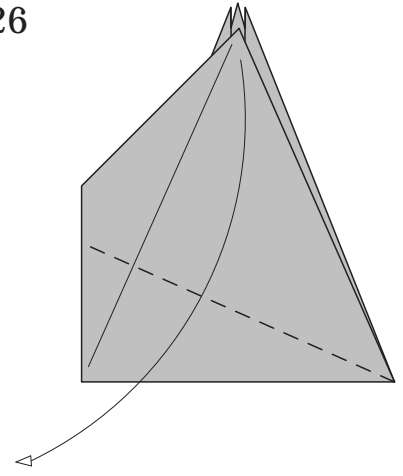

27

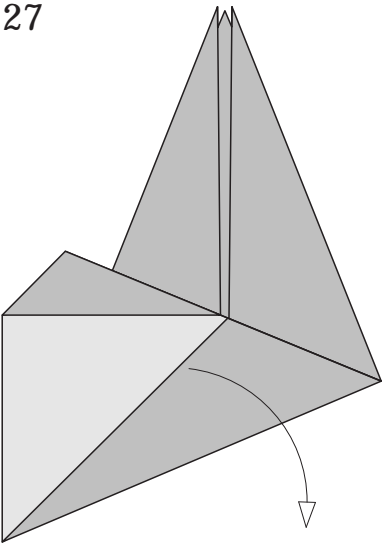

28

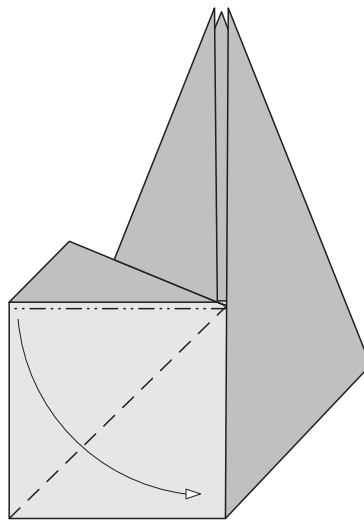

29

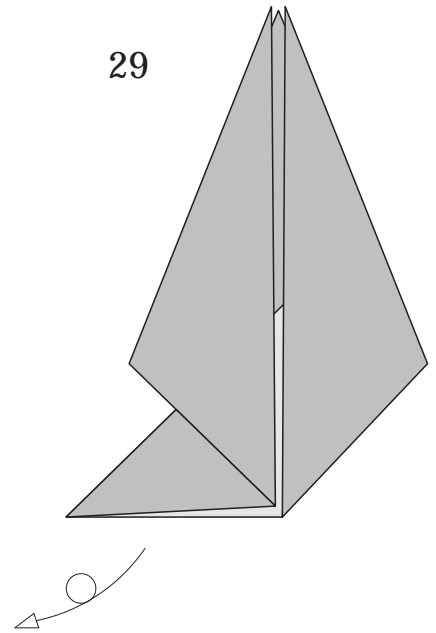

30

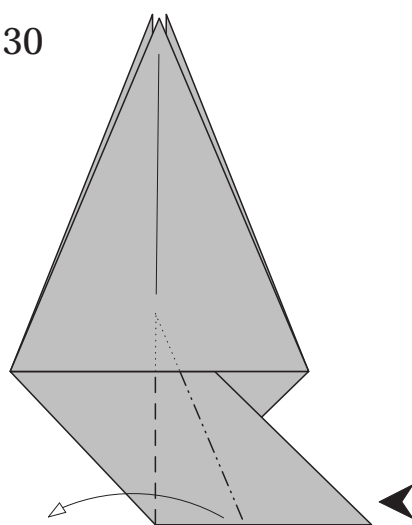

31

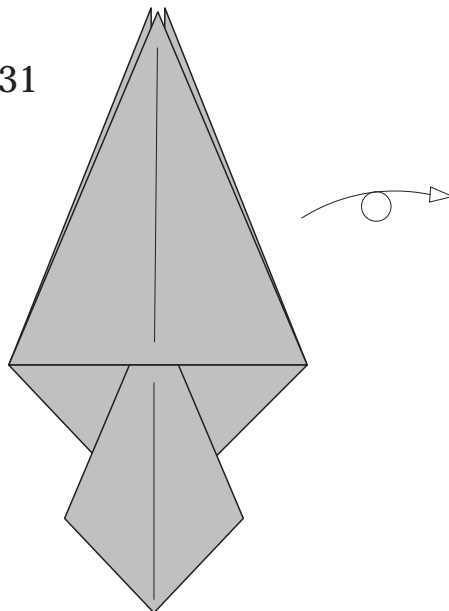

32

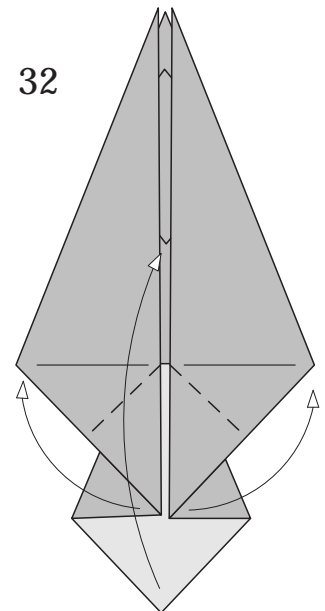

33

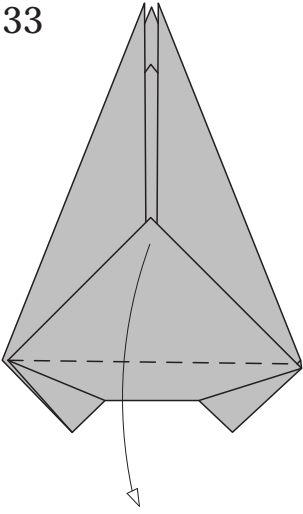

34

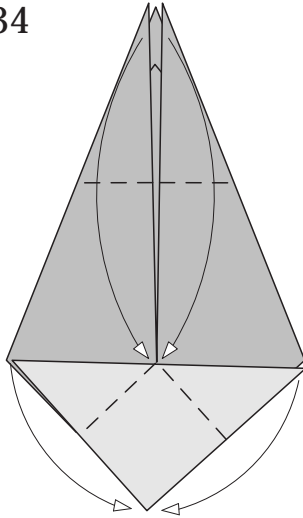

35

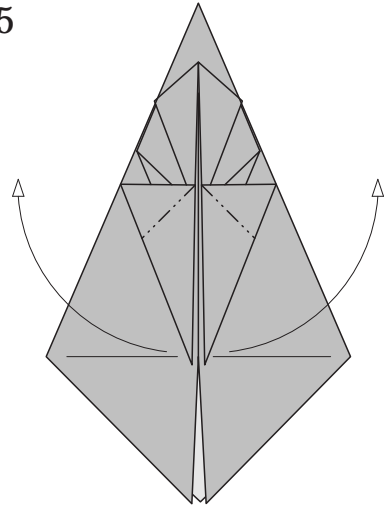

36

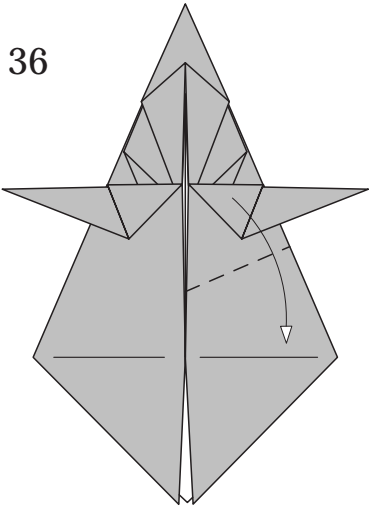

37

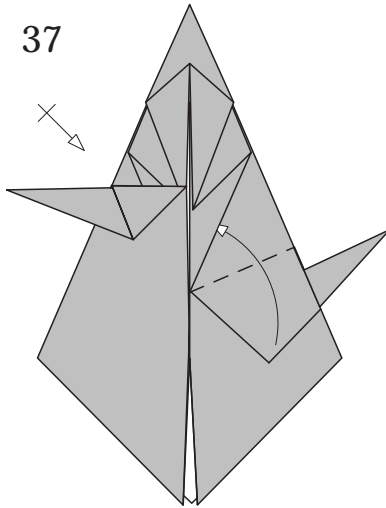

38

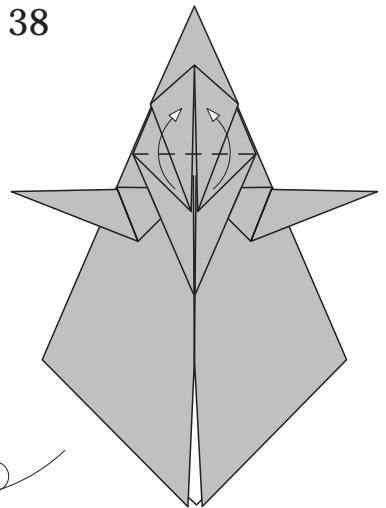

39

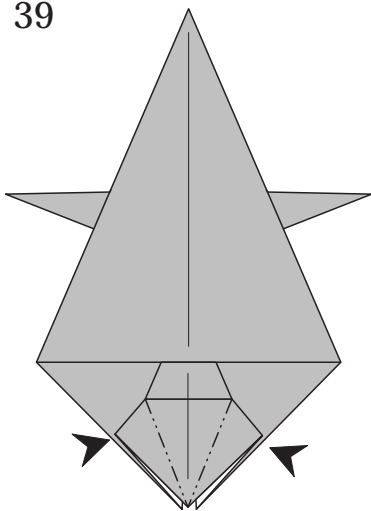

40

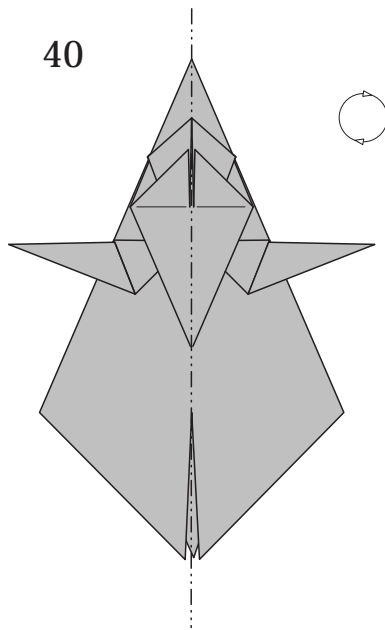

41

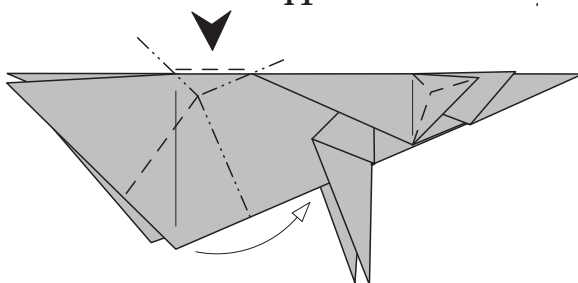

42

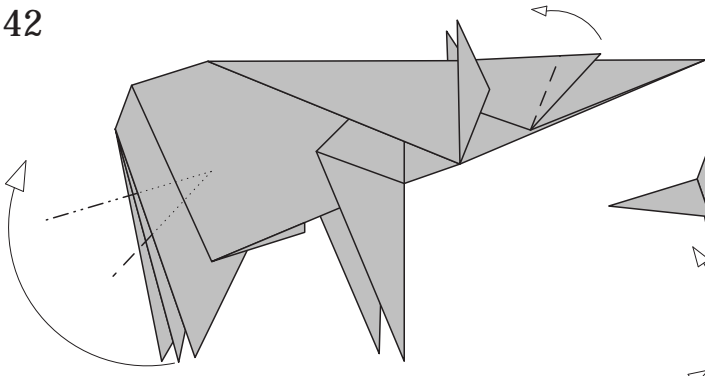

43

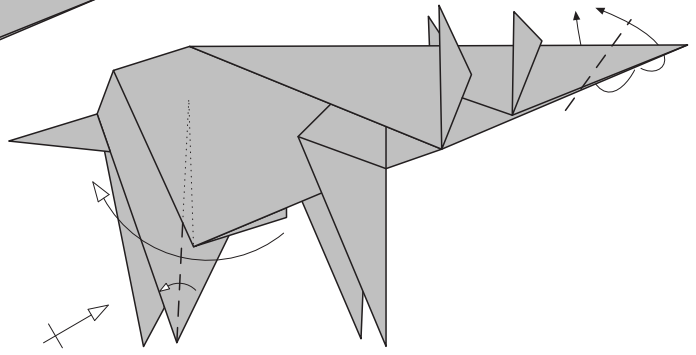

44

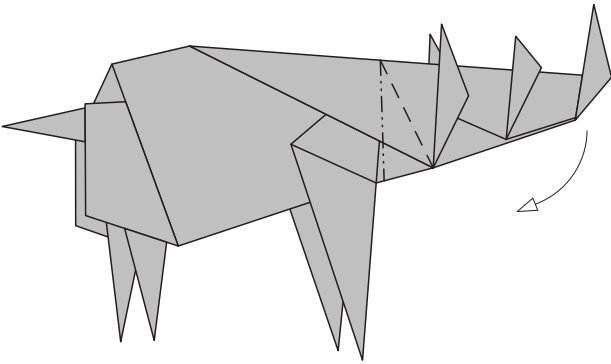

45

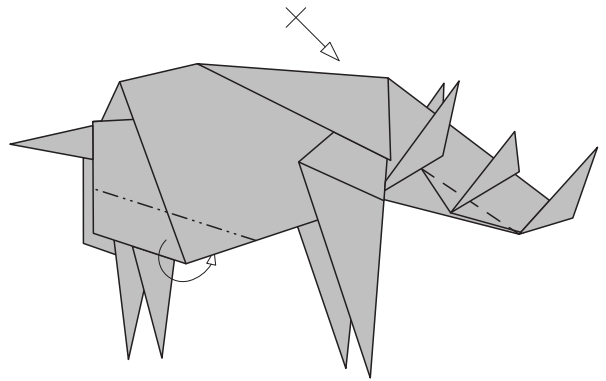

46

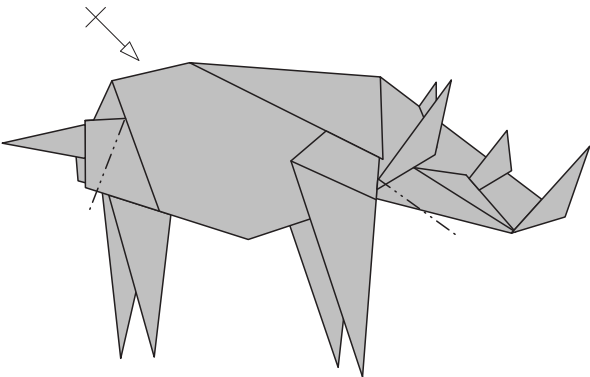

47

