

# Monkey

1

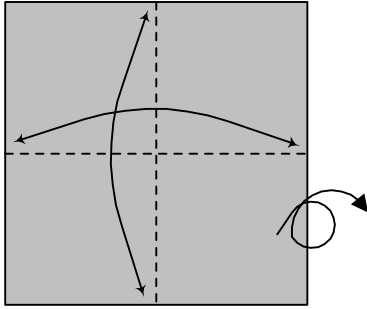

2

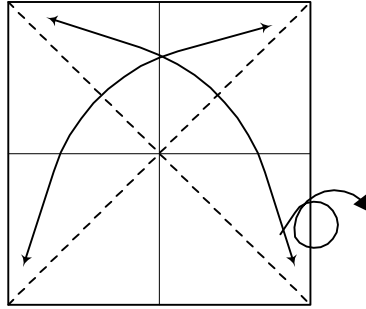

3

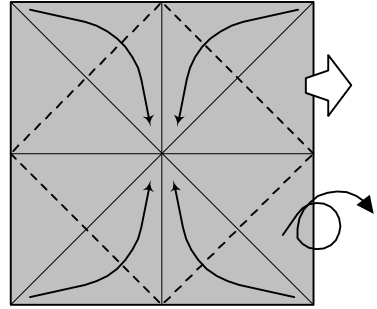

4

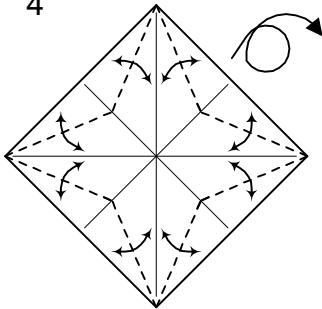

Crease the top layer only.

5

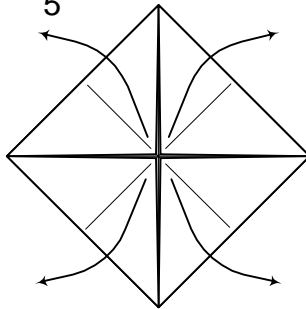

Unfold.

6

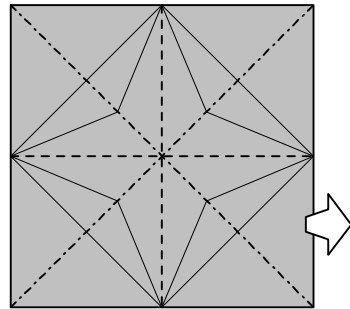

Form a waterbomb base.

7

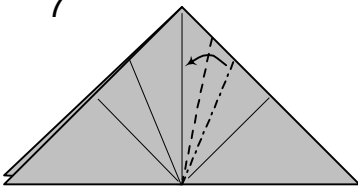

Bisect the angle.

8

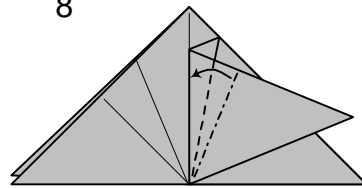

Pleat again.

9

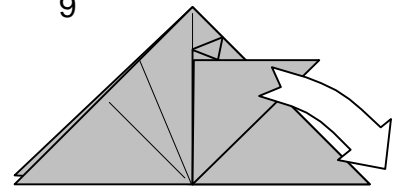

Unfold to step 7.

10

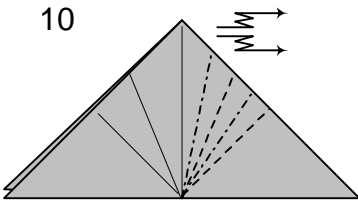

Make 4 inside reverse folds on existing creases.

11

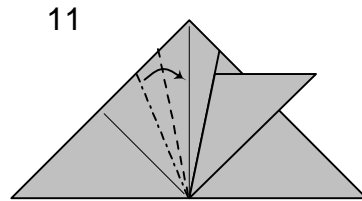

Repeat steps 7-10 on the left side.

12

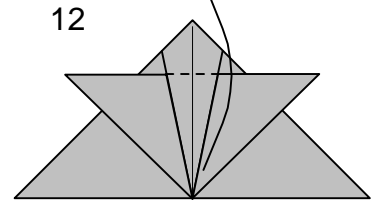

13

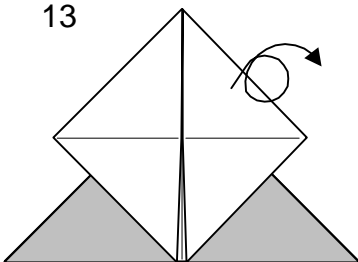

14

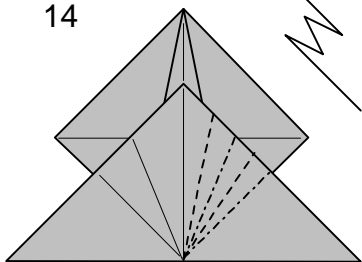

Double pleat (like steps 7-8).

15

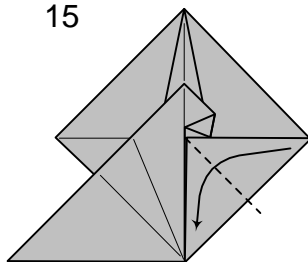

# Monkey

16

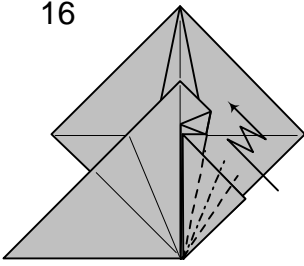

Double pleat the 4 layers.

17

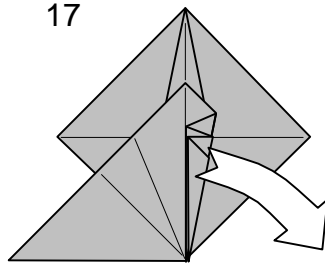

Unfold to step 14.

18

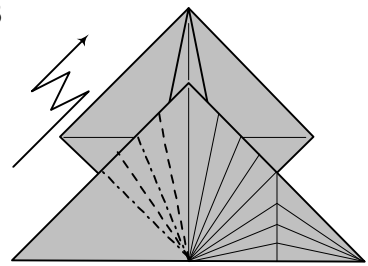

Repeat steps 14 to 17 on the left side.

19

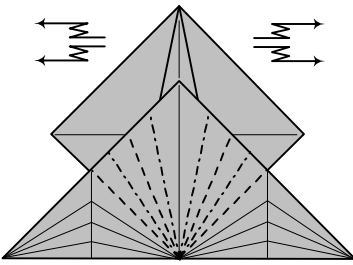

Make 2 sets of inside reverse folds, as in step 10.

20

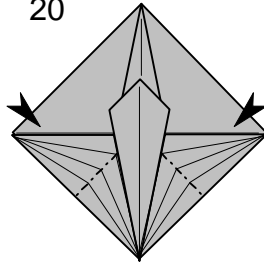

Reverse fold the 2 points.

21

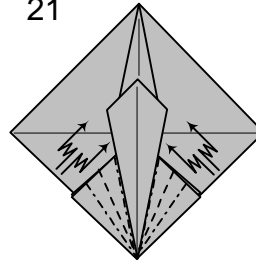

Finally, 4 more sets of reverse folds.

22

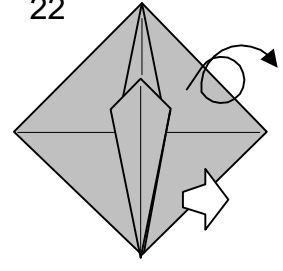

23

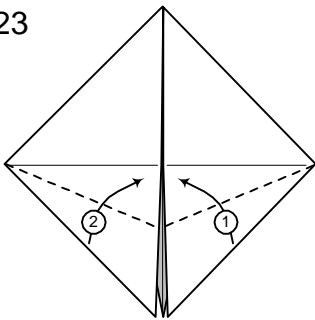

Fold the flap on the right first.

24

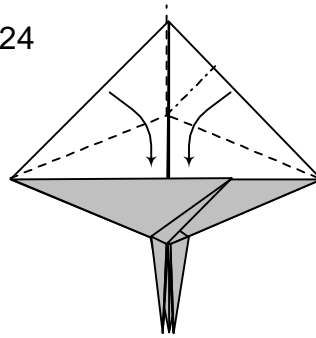

Rabbit ear.

25

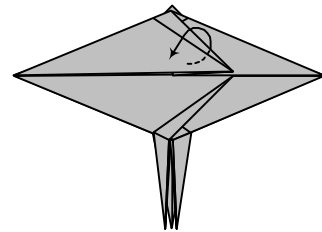

Wrap 1 layer over the point.

26

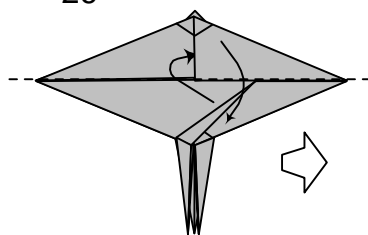

Valley fold the top down while tucking the point behind to lock.

27

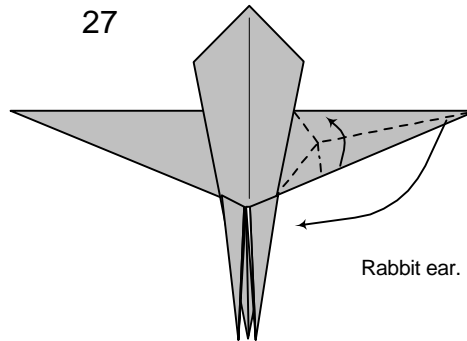

Rabbit ear.

28

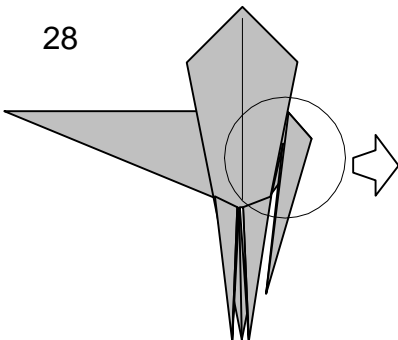

29

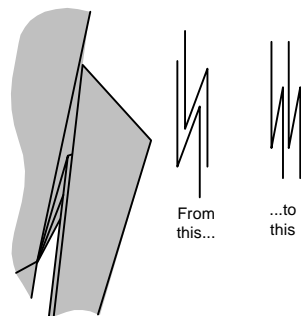

Separate the 2 inner layers, no new creases are required.

30

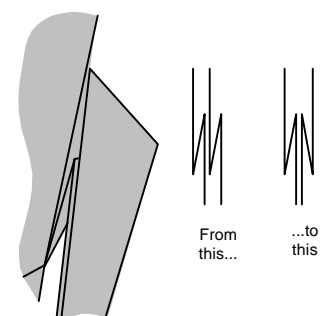

Reverse the existing creases so the flap is inside the model.

# Monkey

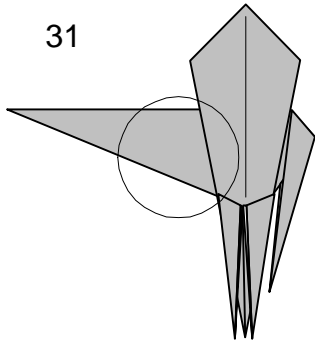

31 Repeat steps 27-30 on the left side.

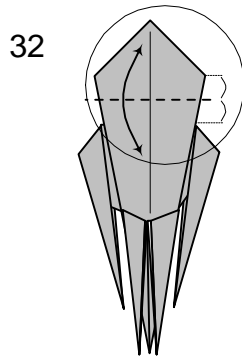

32 Make a sharp crease.

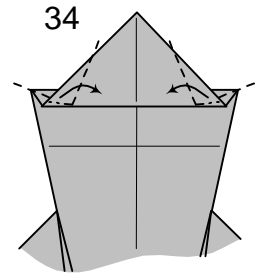
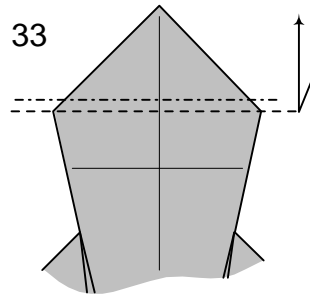

34 Narrow the sides.

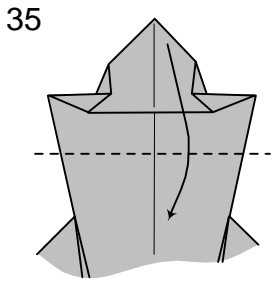

35 Fold the head down.

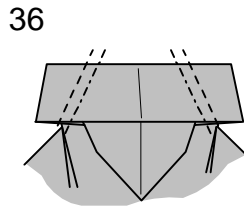

36 Valley and mountain fold each side to make the ears.

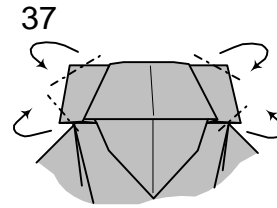

37 Round off the ears.

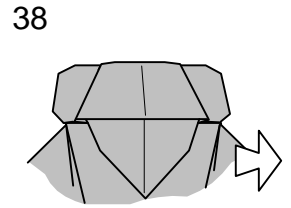

38 The nose can be shaped by slightly 'inflating' the point.

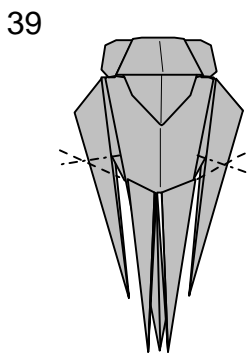

39 Use simple valley and mountain folds to shape the arms.

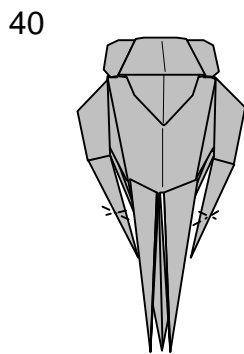

40 Gently squash fold the hands.

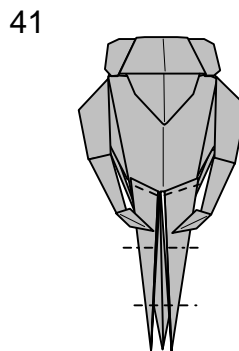

41 Bend the legs into shape.

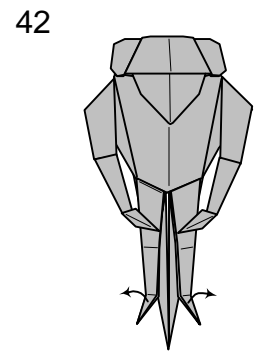

42 Twist the feet and spread the paper a little to make the feet wider.

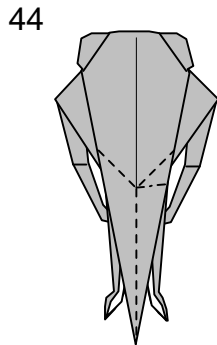
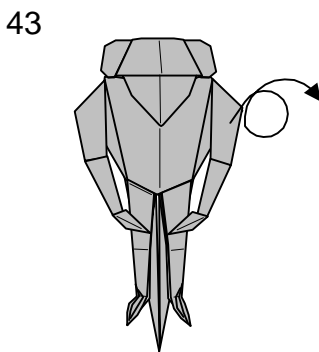

44 Rabbit ear.

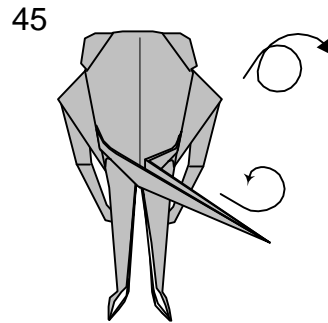

45 Give the tail a nice curve.

