

Badger

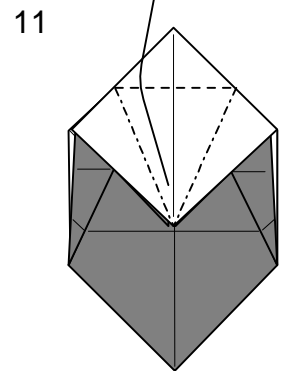

Repeat steps 4 to 9 on the left side

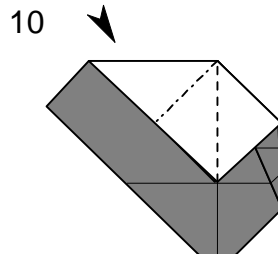
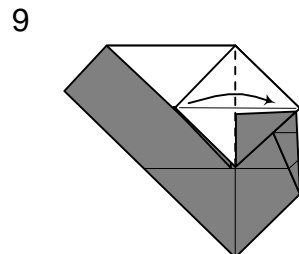
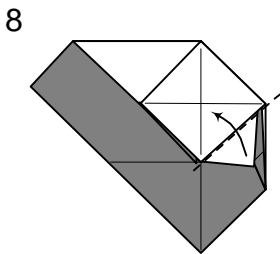
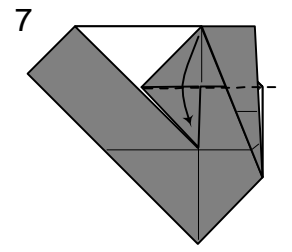
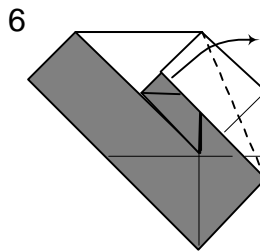
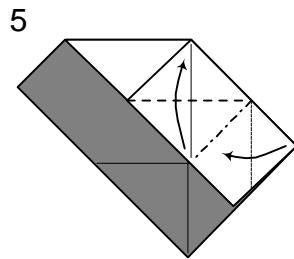
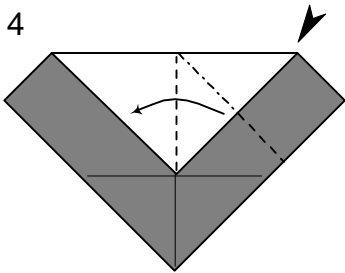
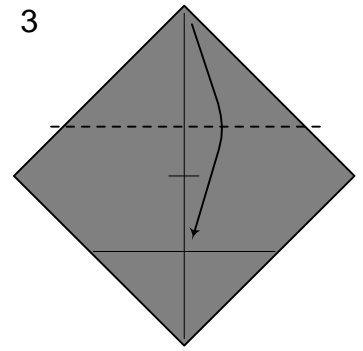
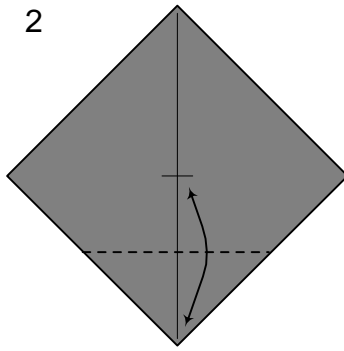
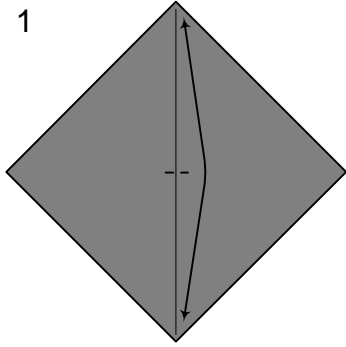
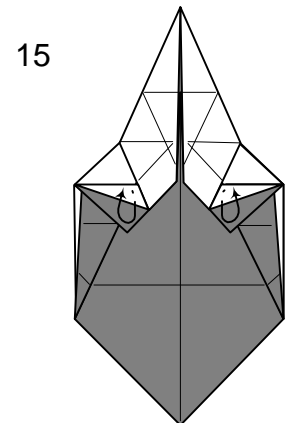
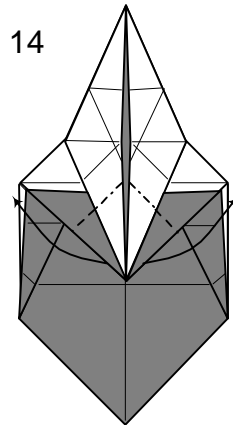
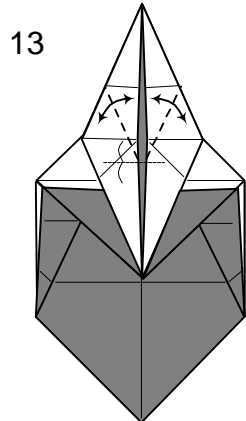
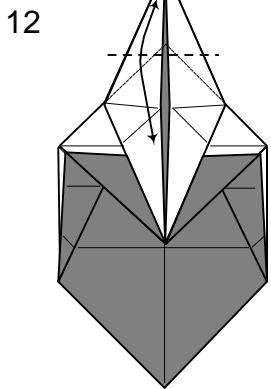

Crease tip down just a little below the point behind

Crease a single layer down to half way between the two horizontal creases

Inside reverse folds

Wrap one layer to the front (colour change)

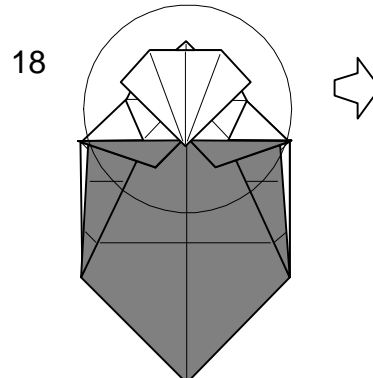
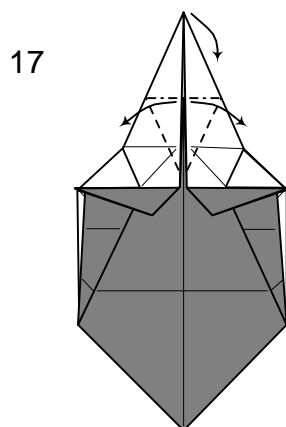
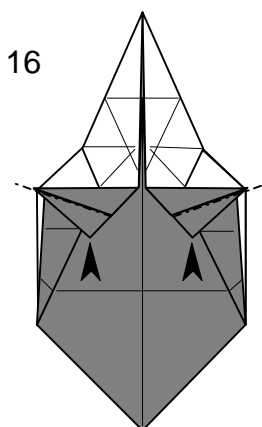

Badger

19

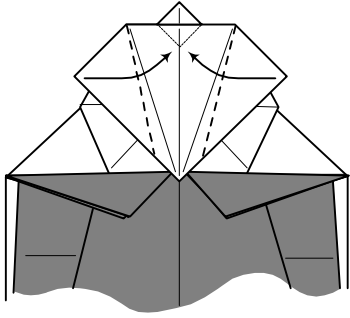

Fold sides towards the base of the 'imaginary' square

20

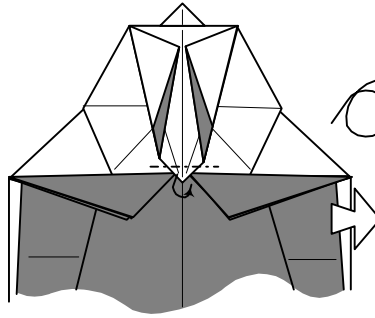

21

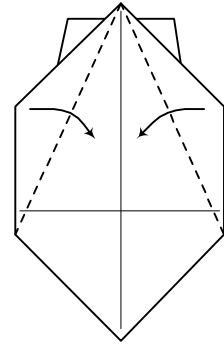

22

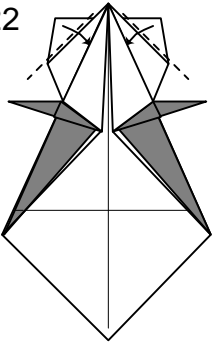

23

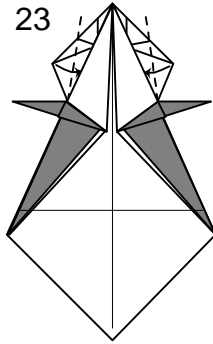

24

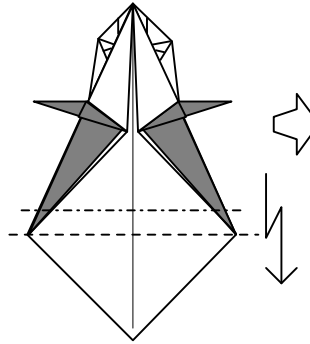

25

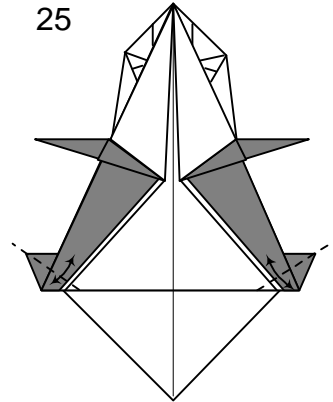

26

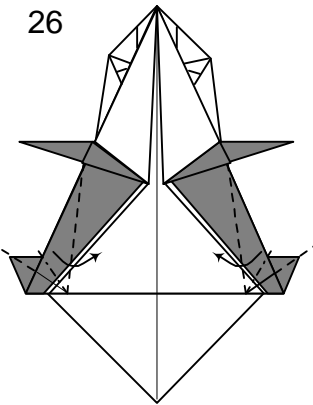

27

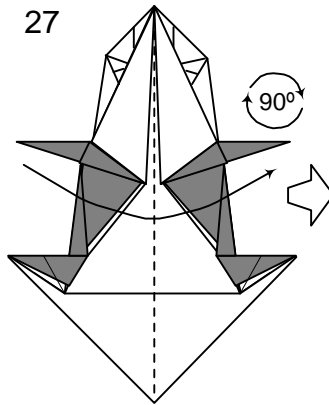

28

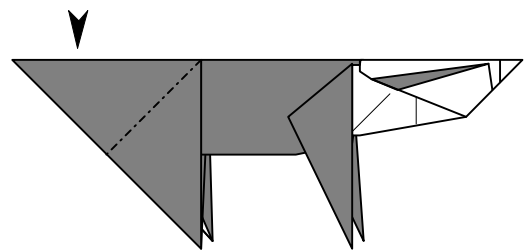

29

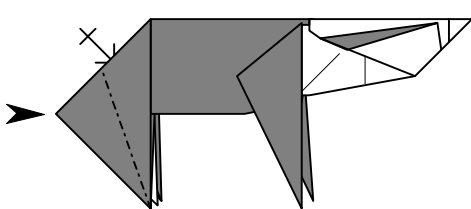

30

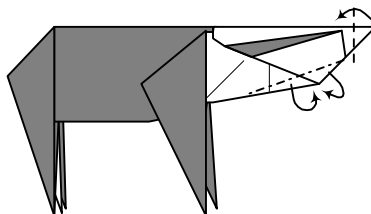

31

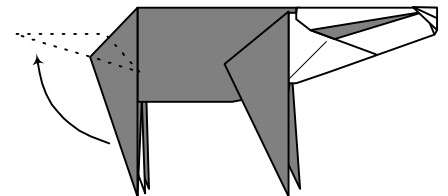

32

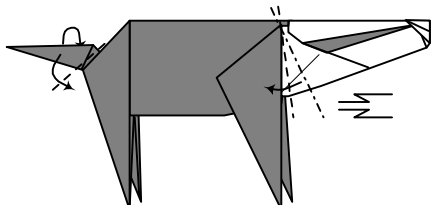

33

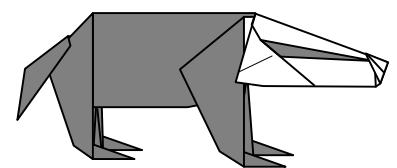
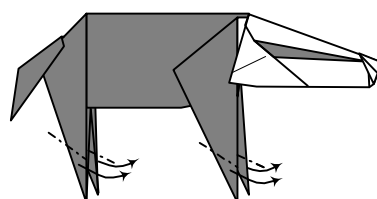

Make 4 inside reverse folds