

Phu Tran Rose



Diagrammed: Phuc Nguyen
v.2

Phu Tran Rose

Designer: Phu Tran
Diagrammed By: Phuc Nguyen
<http://pnpurdueorigami.blogspot.com>
9/28/2005

Recommended Paper Size: 11" x 11" or 25cm x 25cm

1

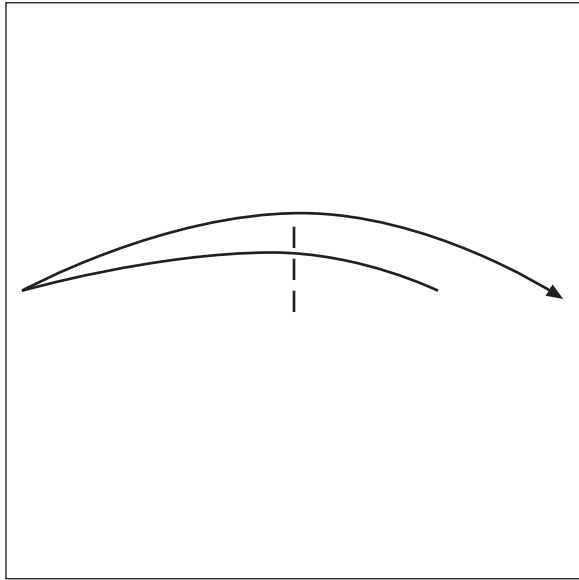

2

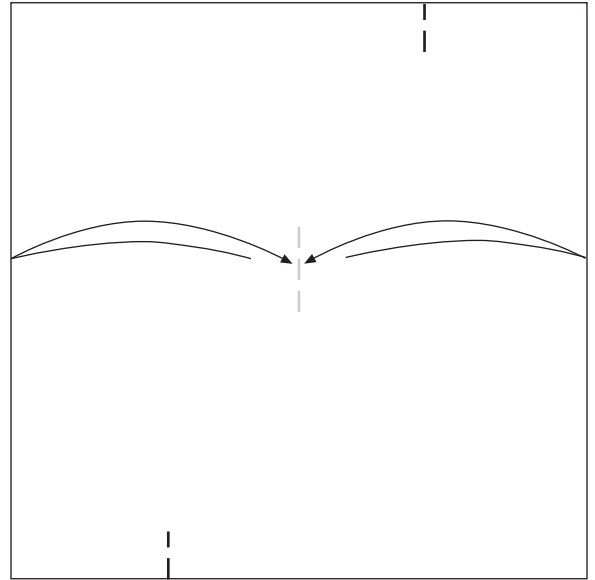

3

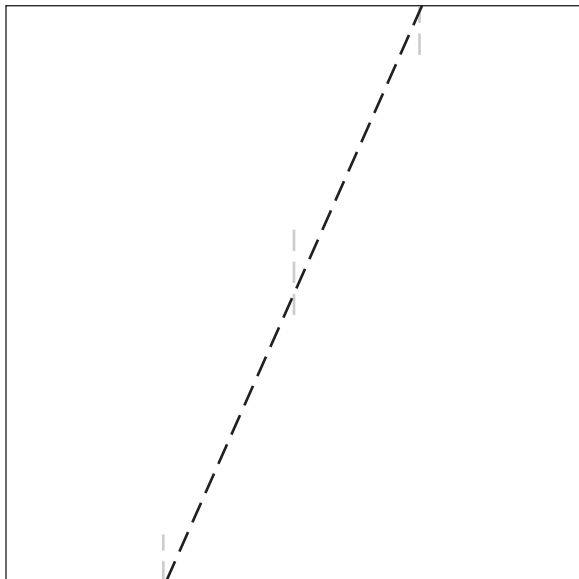

4

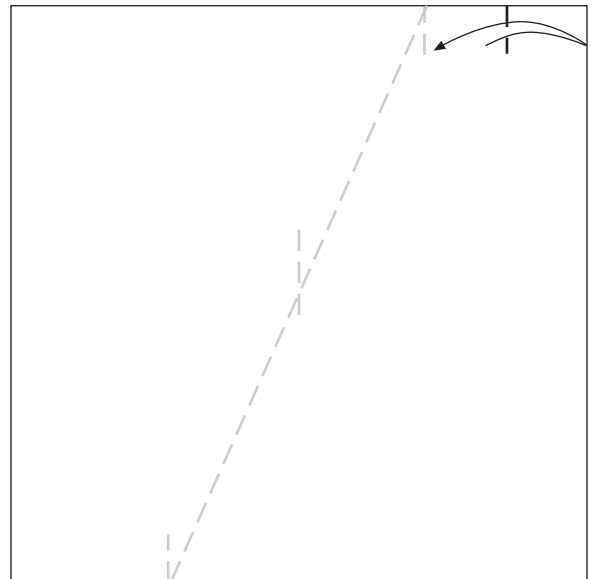

5

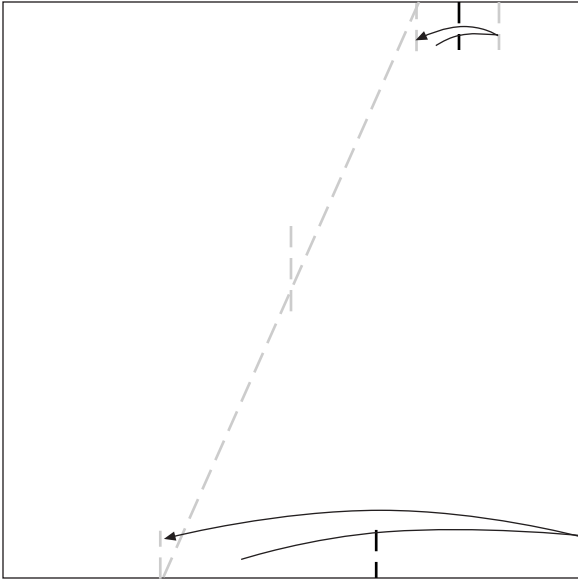

6

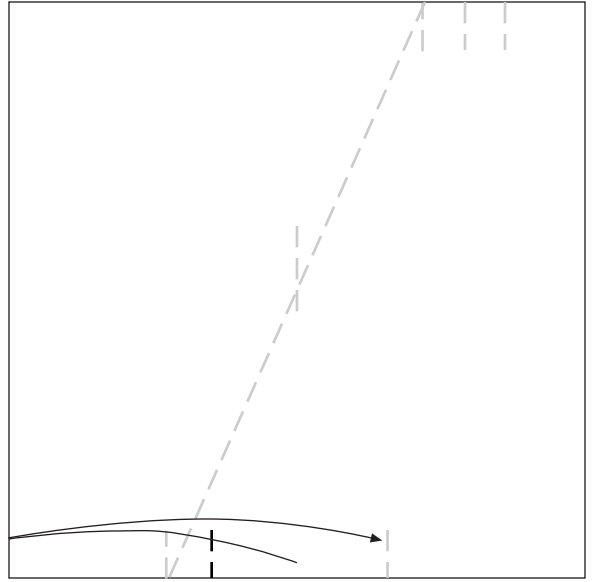

7

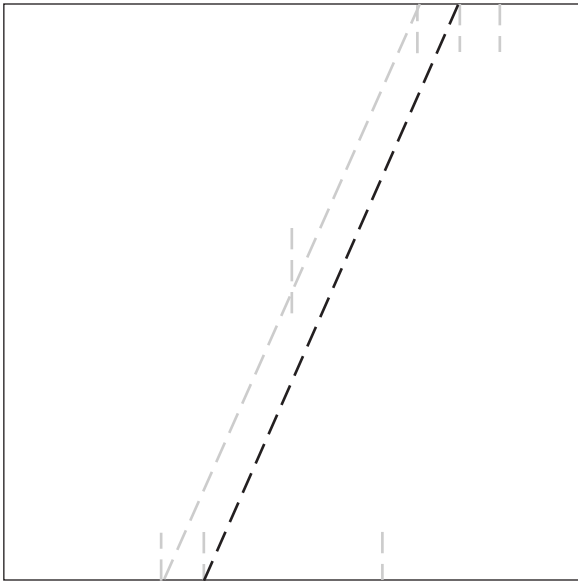

8

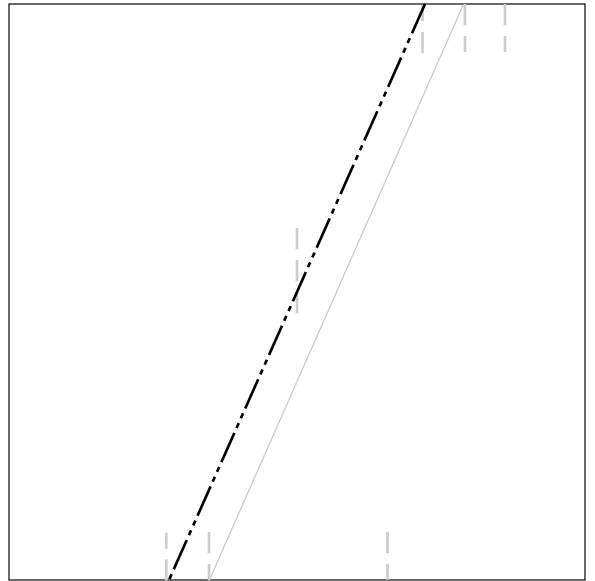

9

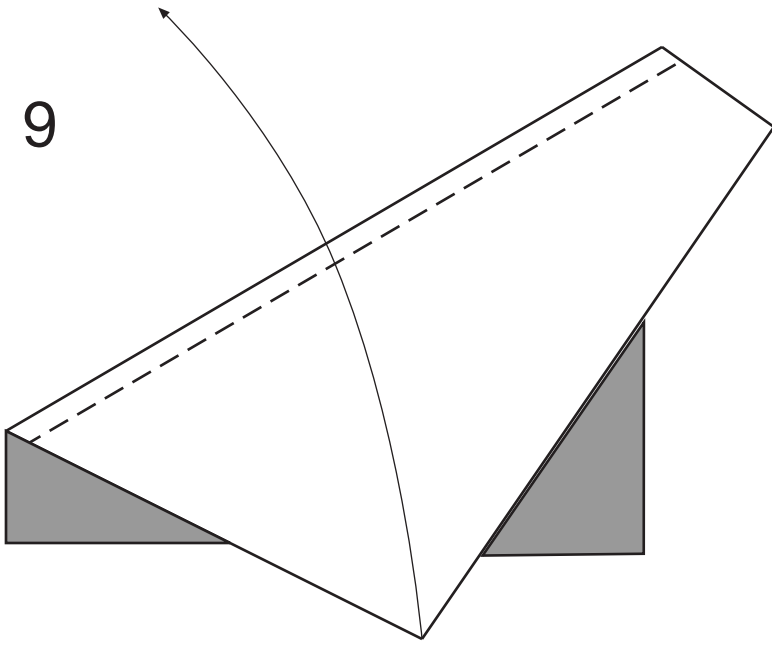

valley fold up the crease made in step 7.
Repeat behind. Using the edge as a guide.

10

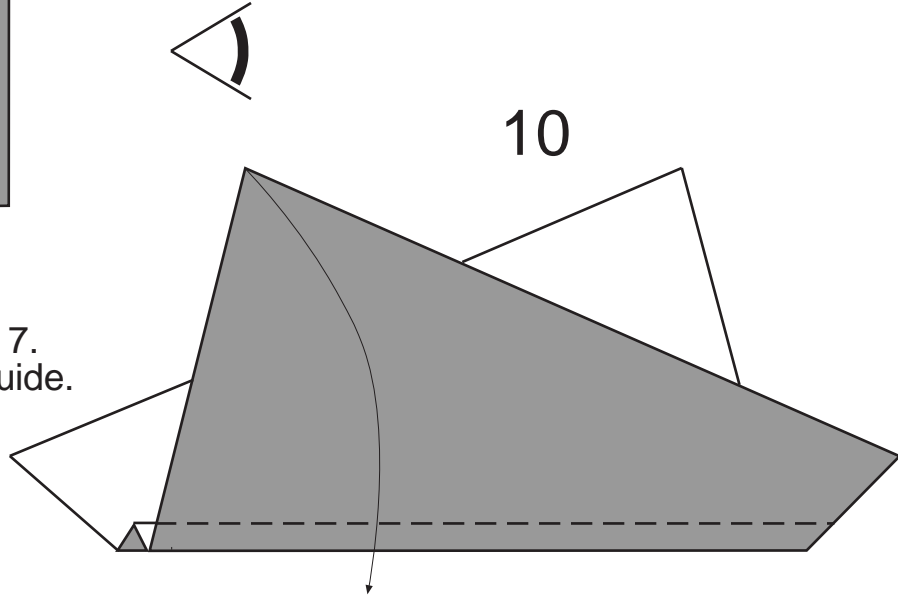

Pleat fold up and down 7 times. Using the
edge as the reference guide. Repeat from
behind. *Suggestion* Match up the folds.
Front and behind.

11

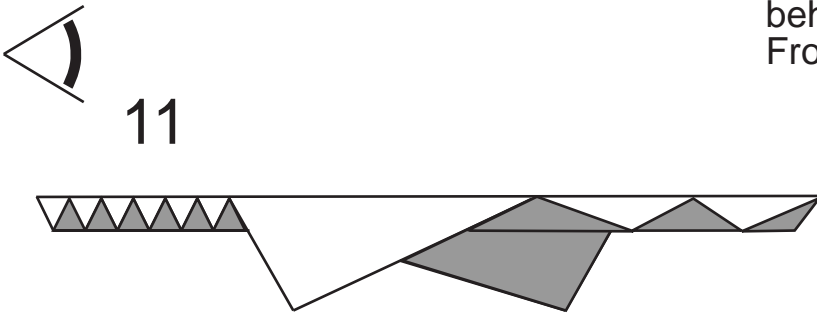

Unfold everything.

12

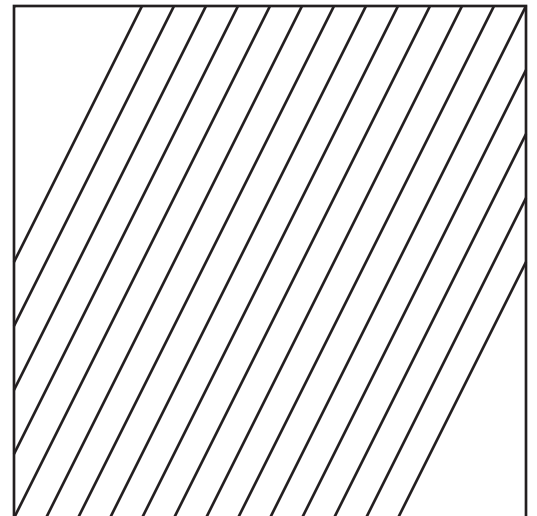

12

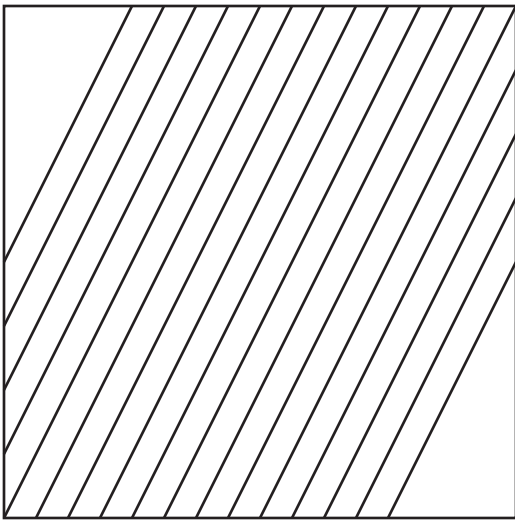

13

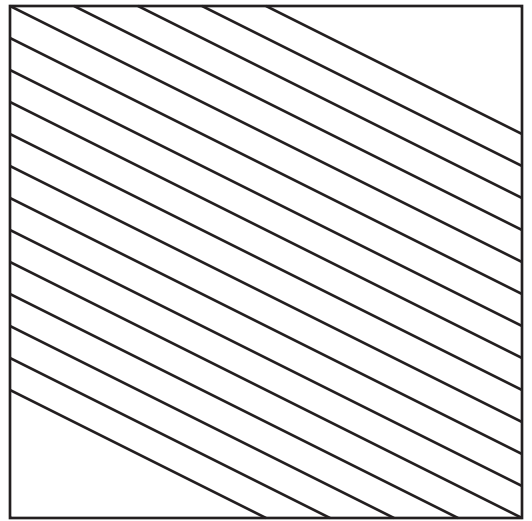

90



Repeat steps 1-11

14

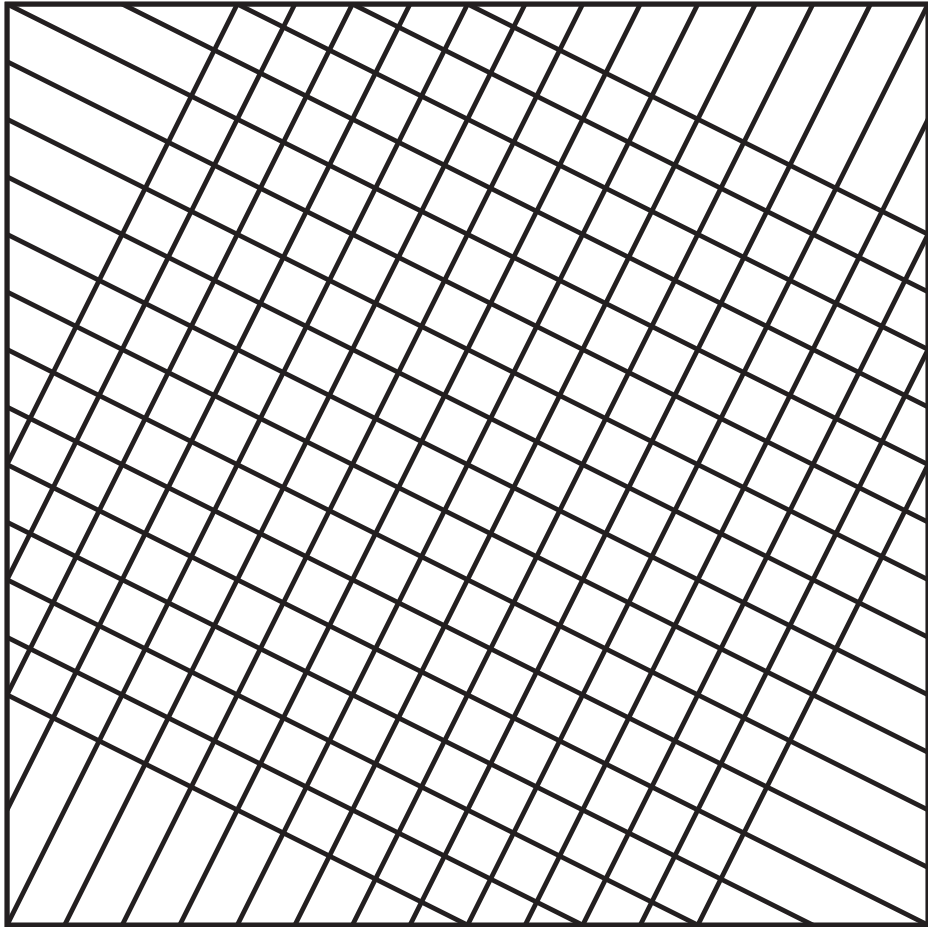

15

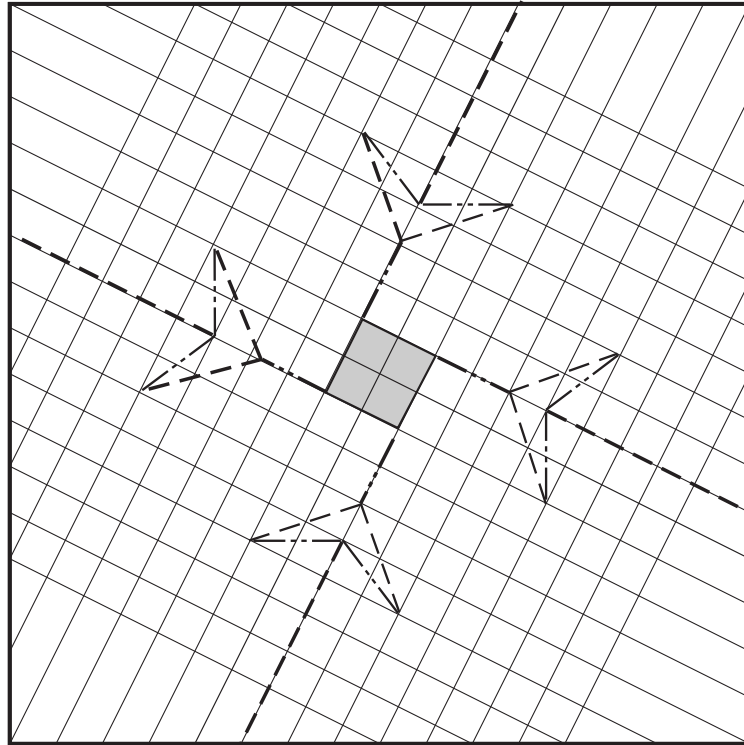

16



in progress...collapse the indicated creases. Do NOT flatten the model.



17

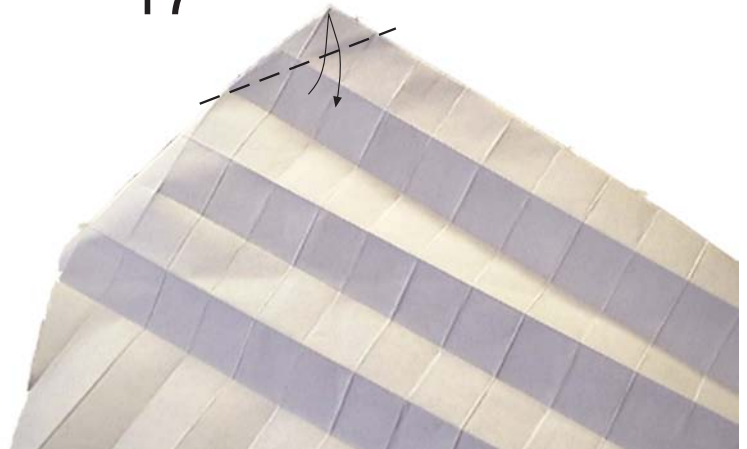

Repeat to other 3.

18

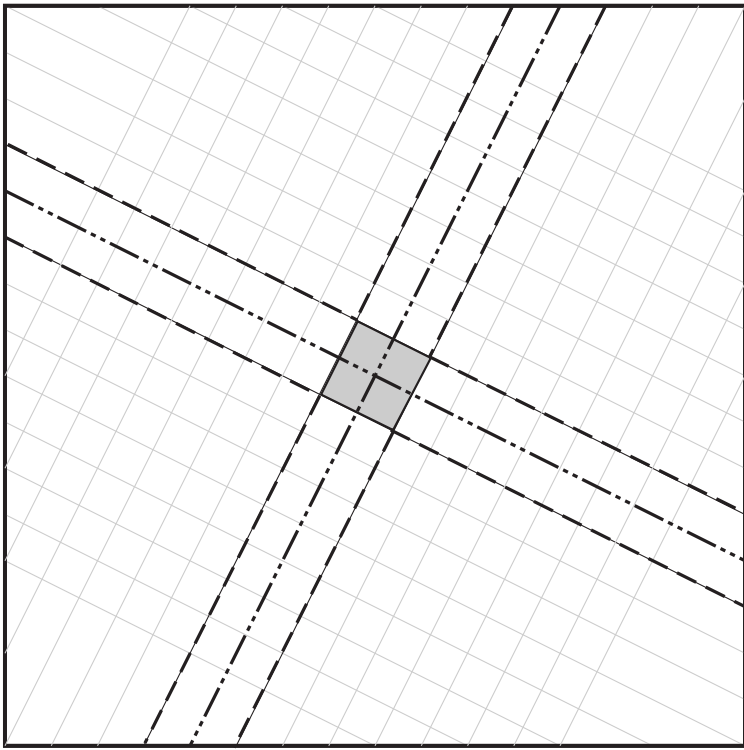

19



20



Swirl fold to the right.

21

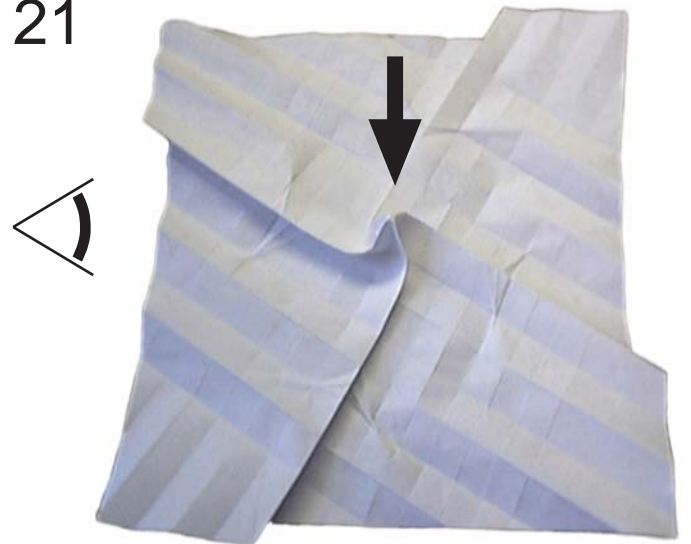

Squash the center

22



23



Repeat to other 3 flaps

24



in progress...add in creases made in step 15. Form the cyclinder

25



Like so. (Upside down view)

26

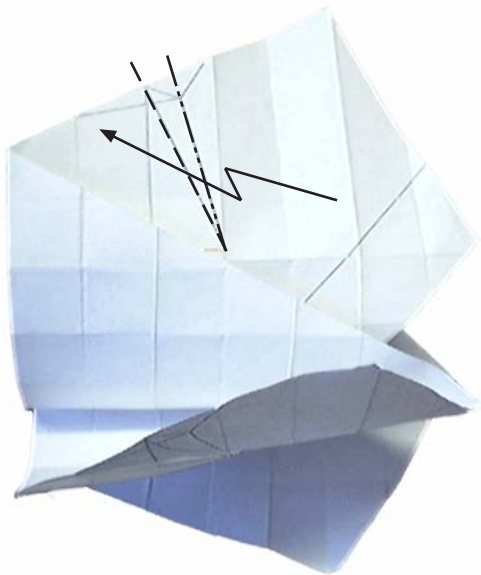

Repeat to other flaps

27

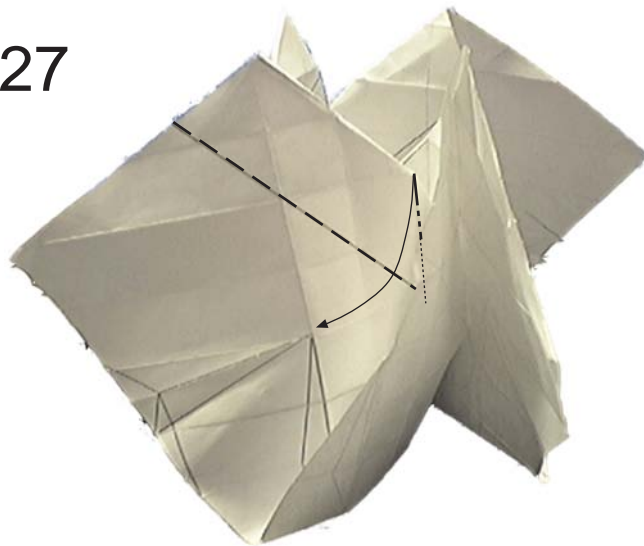

Fold down

28



Result of step 27. Repeat on other flaps.

29



Result of step 27-28.

30

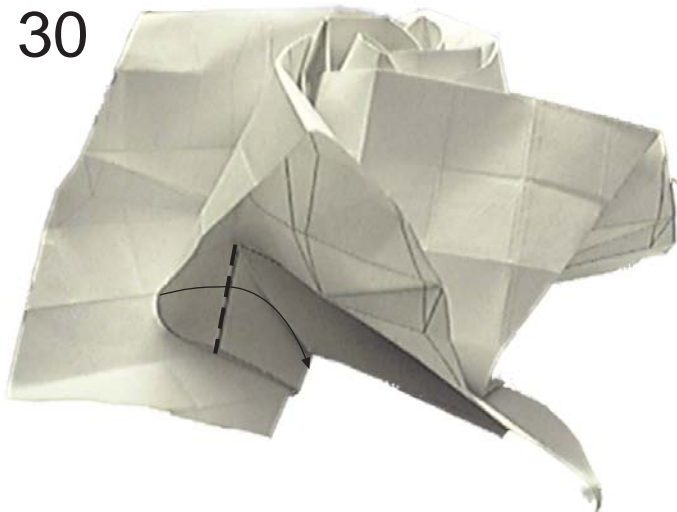

31

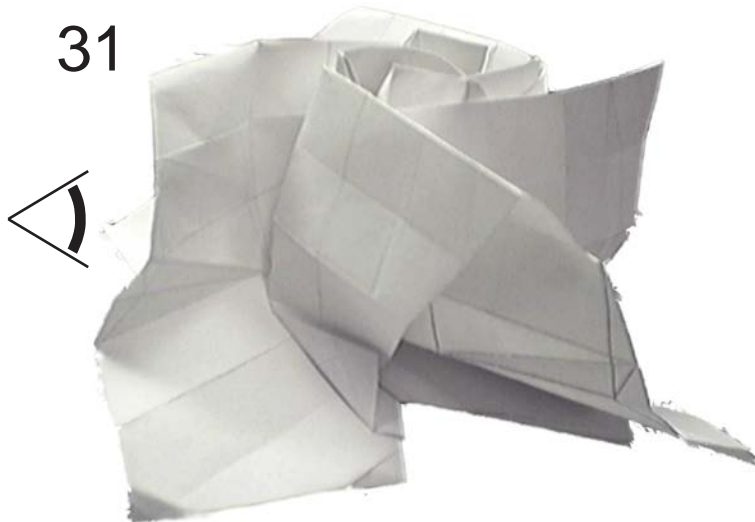

32



Push at the arrow.

33



Collapse and crease the flap.

34



Result of steps 32-33. Repeat on other flaps.

35

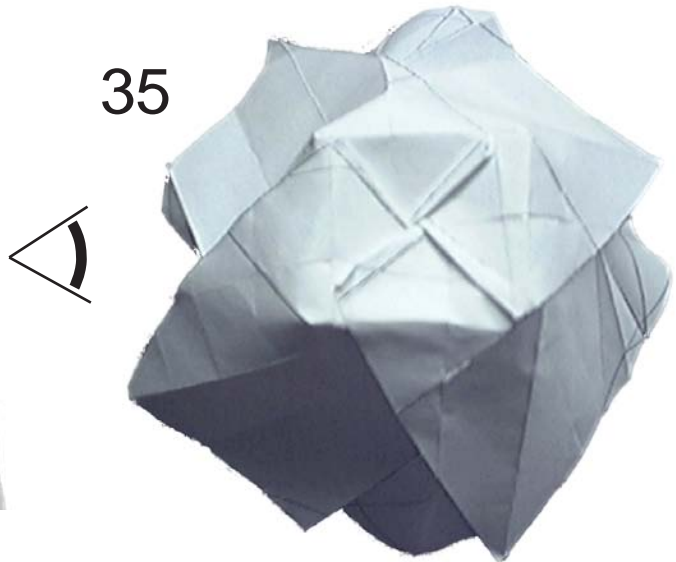

36

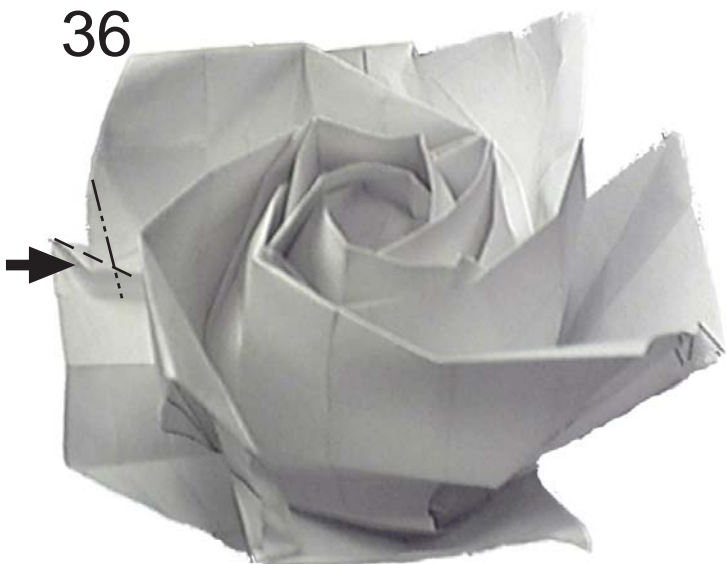

Repeat to all.

37



Release step 36 and form the new crease. Collapse. Repeat to all.

38



39



I suggest pinching this fold then shape. Repeat on all flaps.

