

Escorpión de Fco. Javier Caboblanco (Abril 1996)

Cefalotorax
y patas

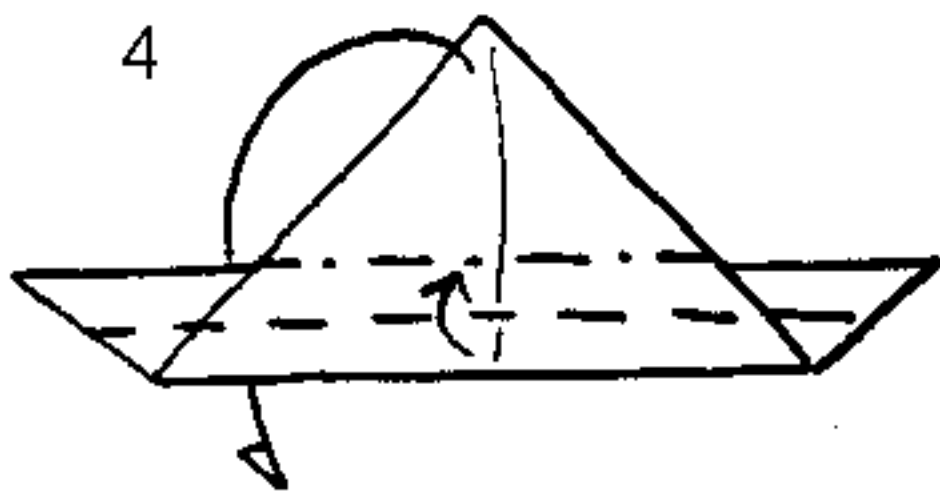

[Hacer 4 piezas como esta]

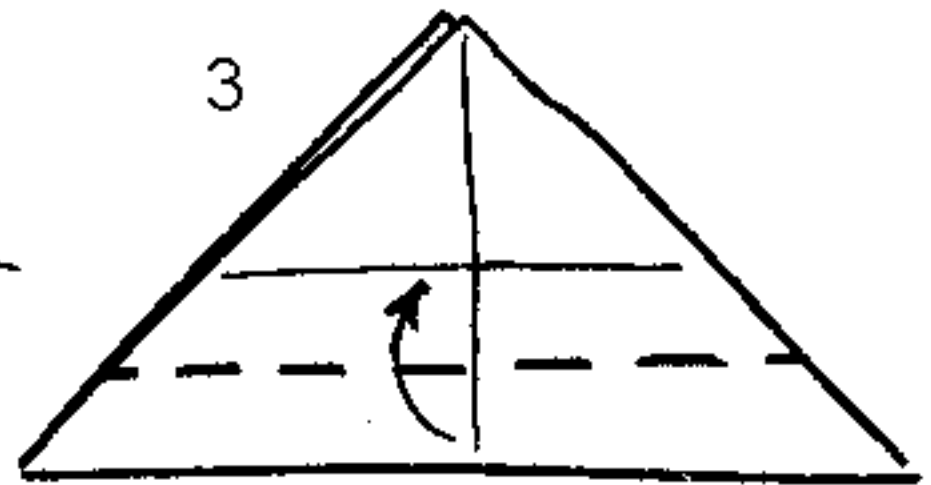
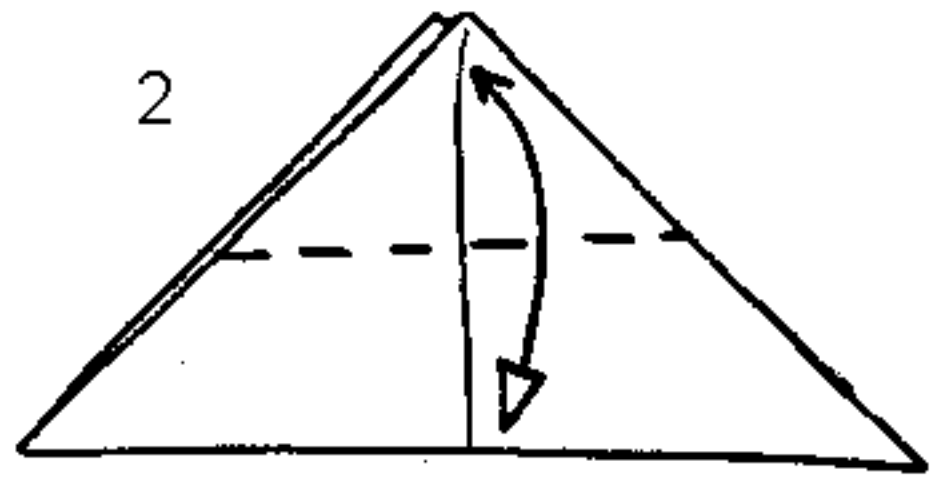
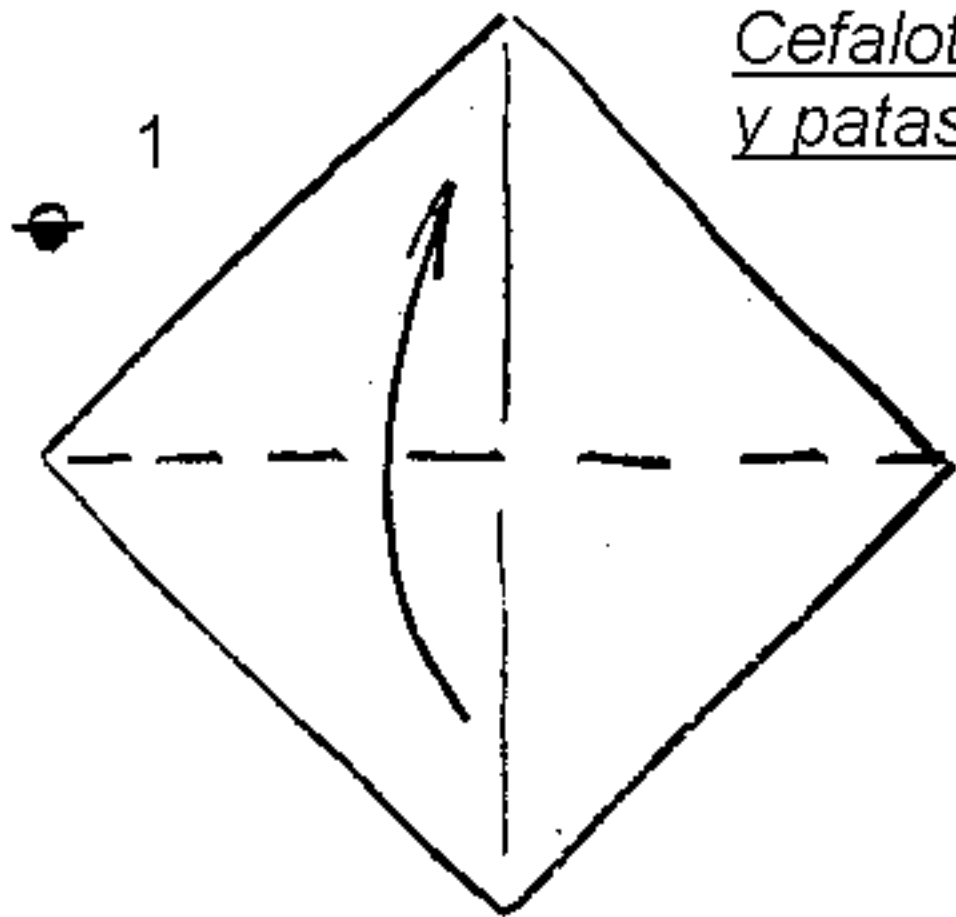
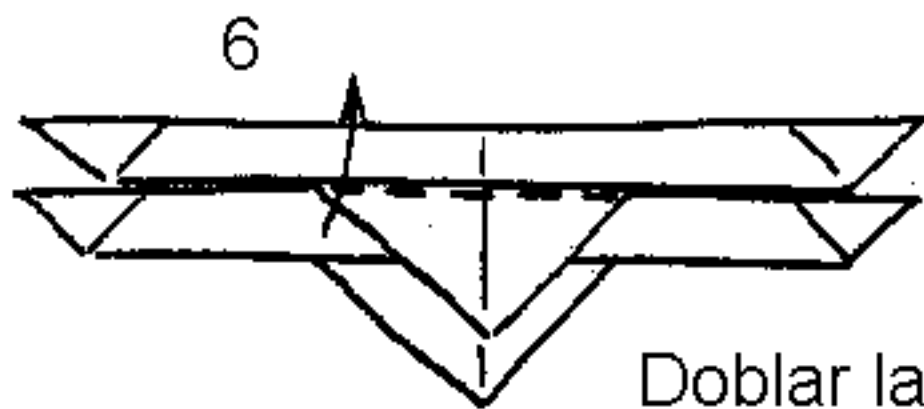
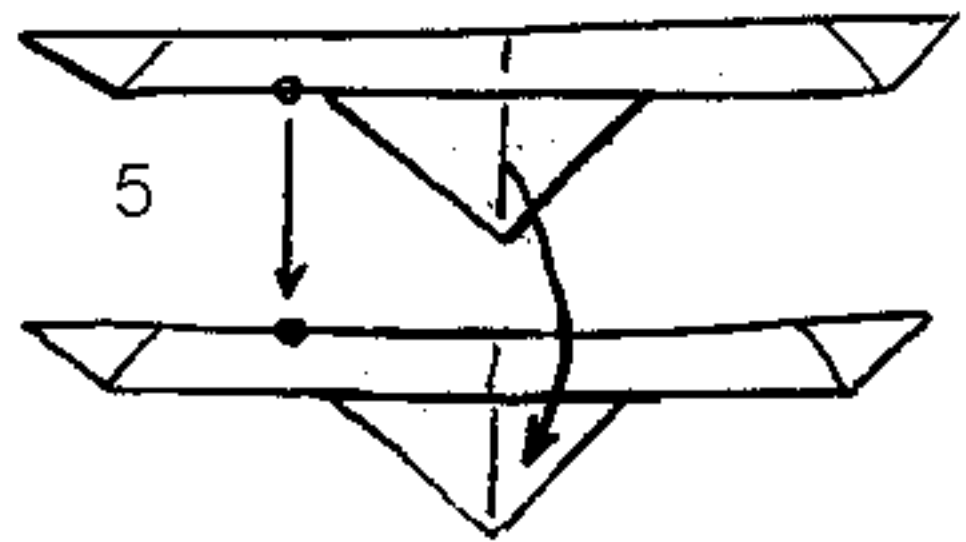

Doblar las dos
piezas

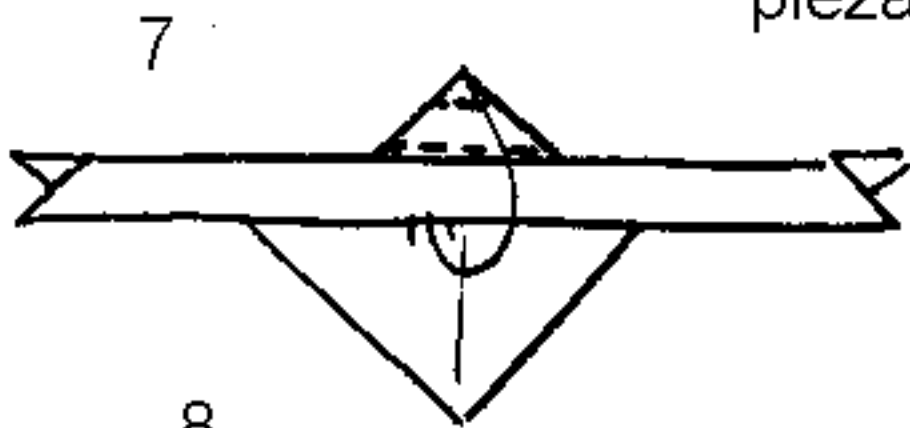

Vista
inferior

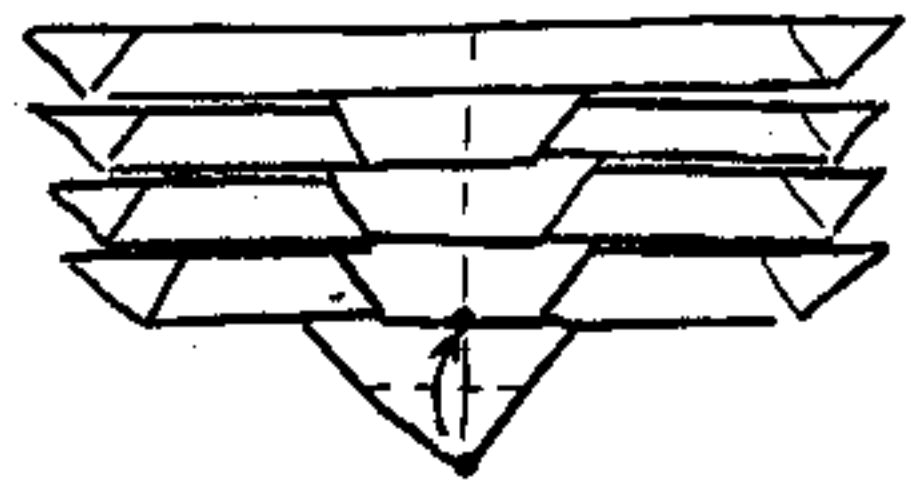
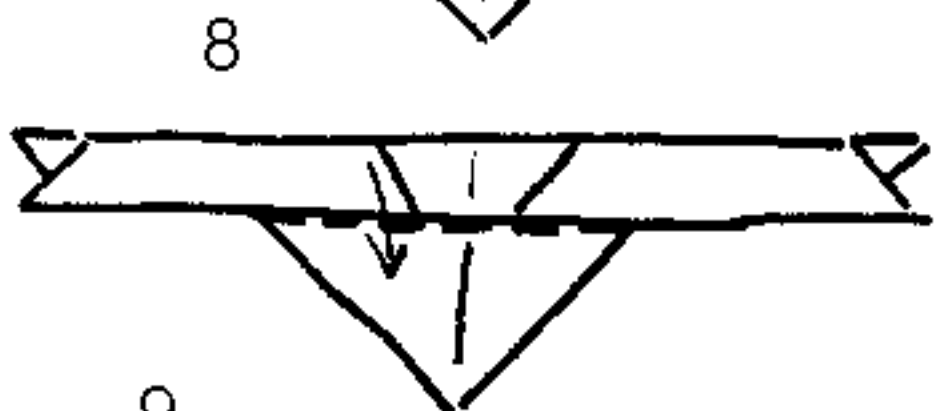

Vista
superior

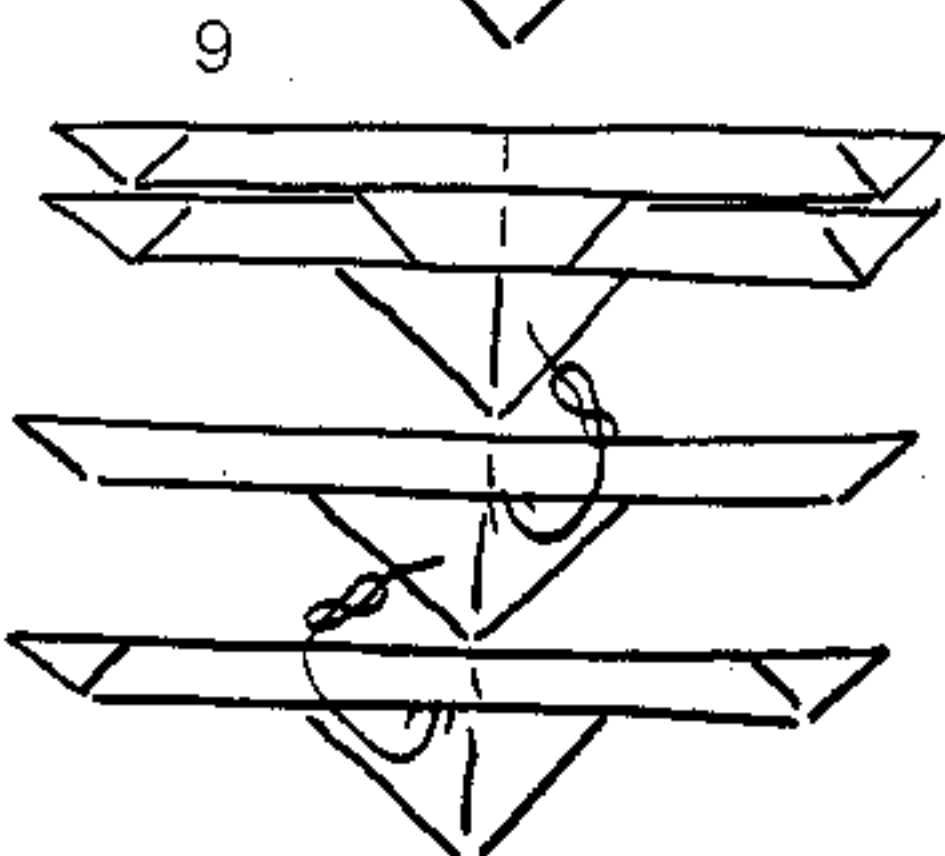

10

COLA

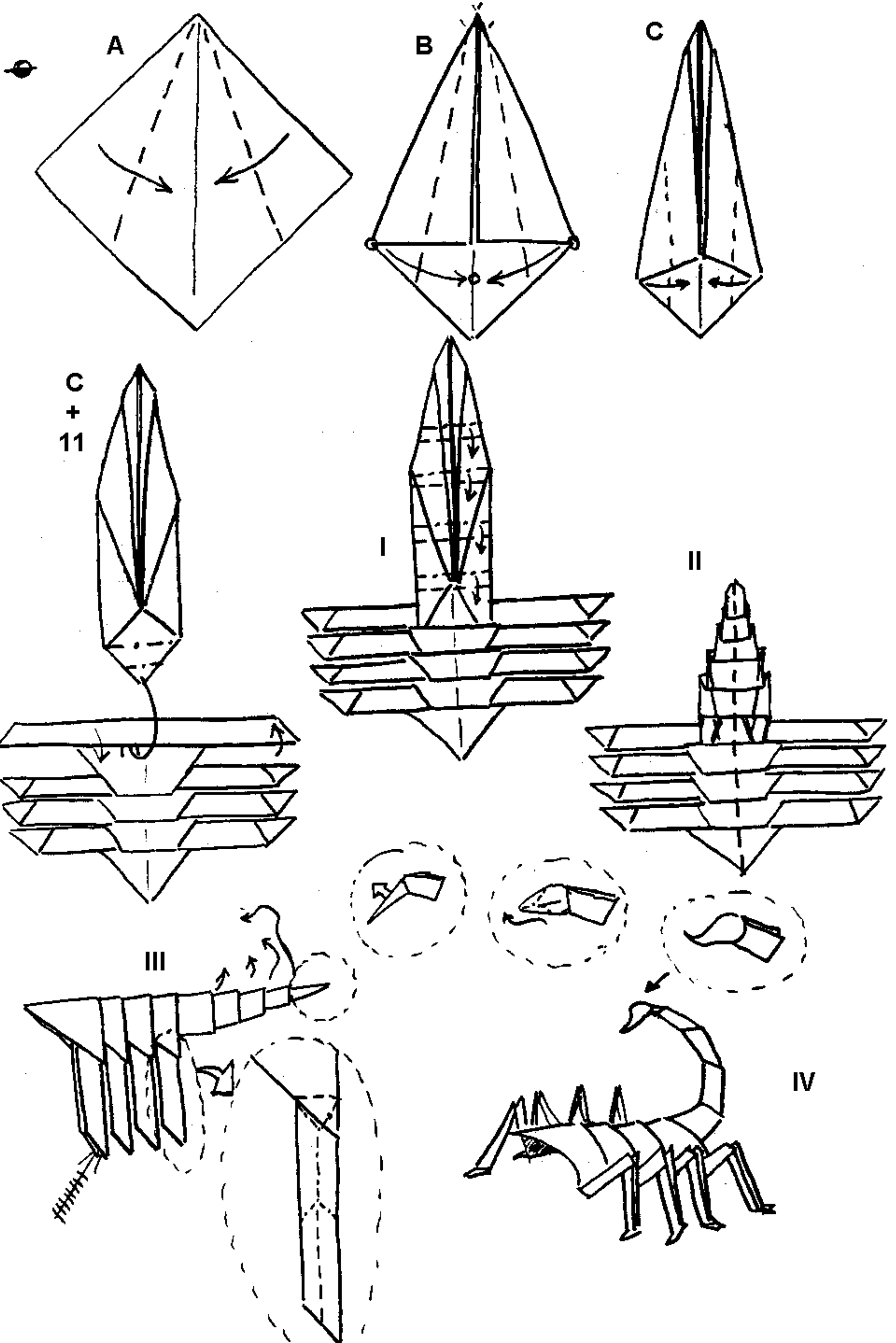

PINZAS

- Izquierda

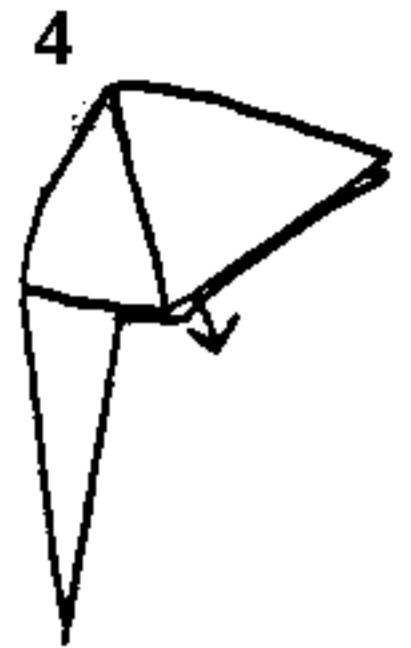
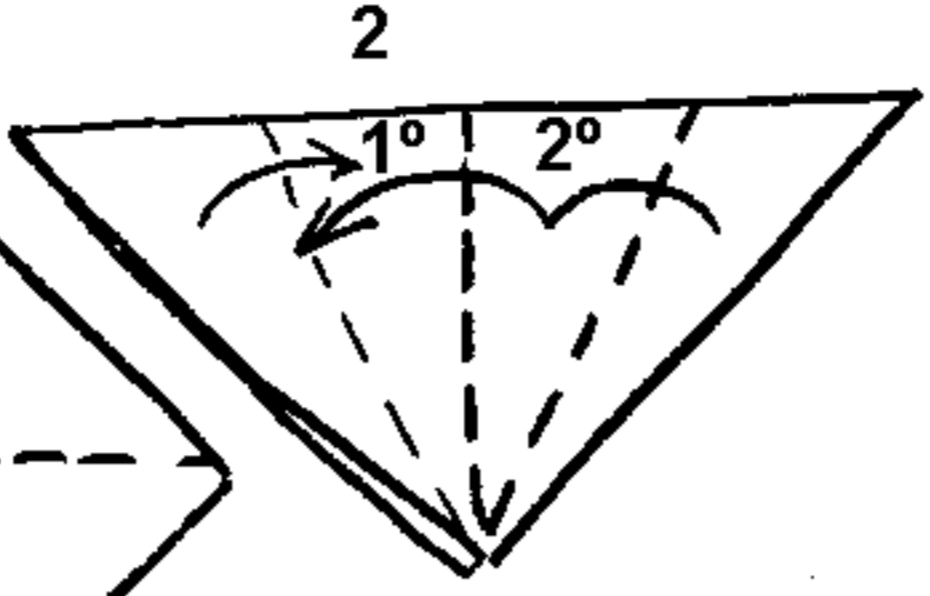
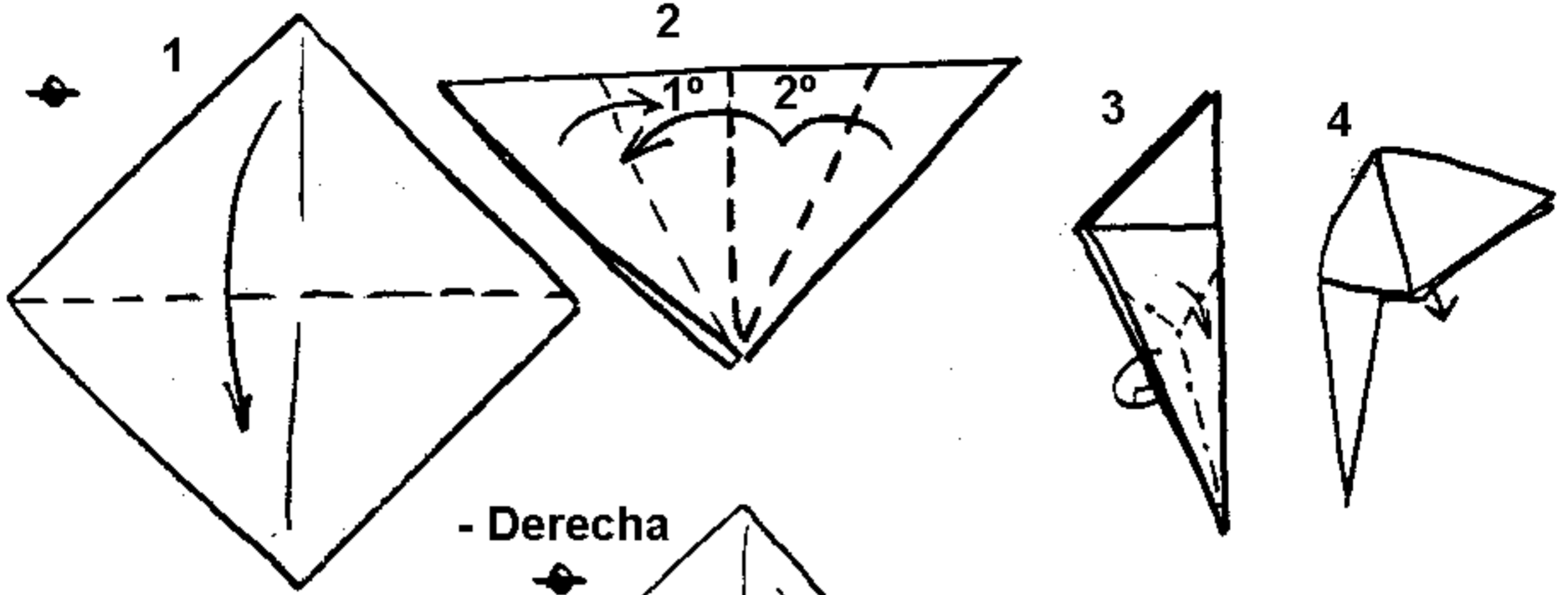

- Derecha

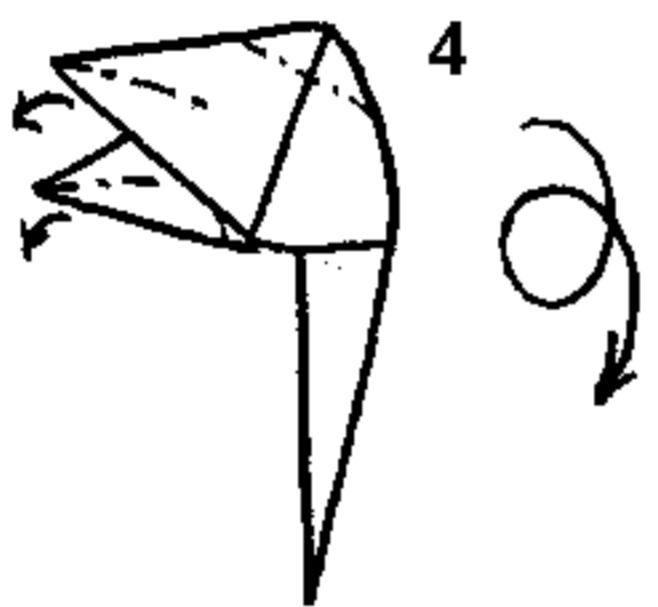
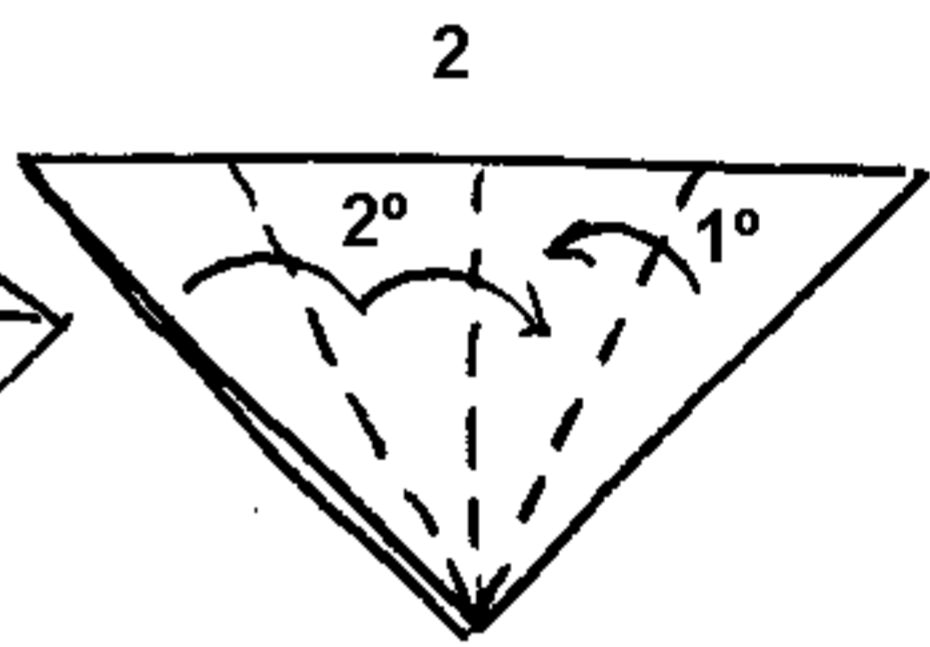
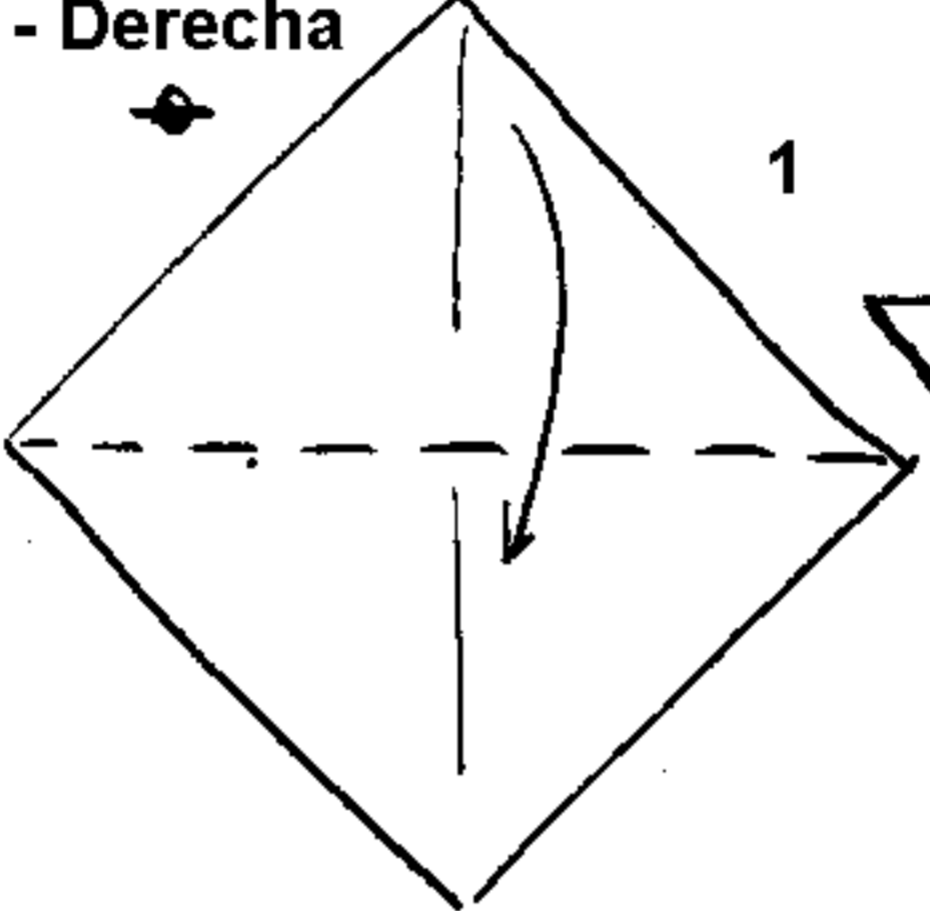

ENGARCE DE LAS PINZAS AL CUERPO

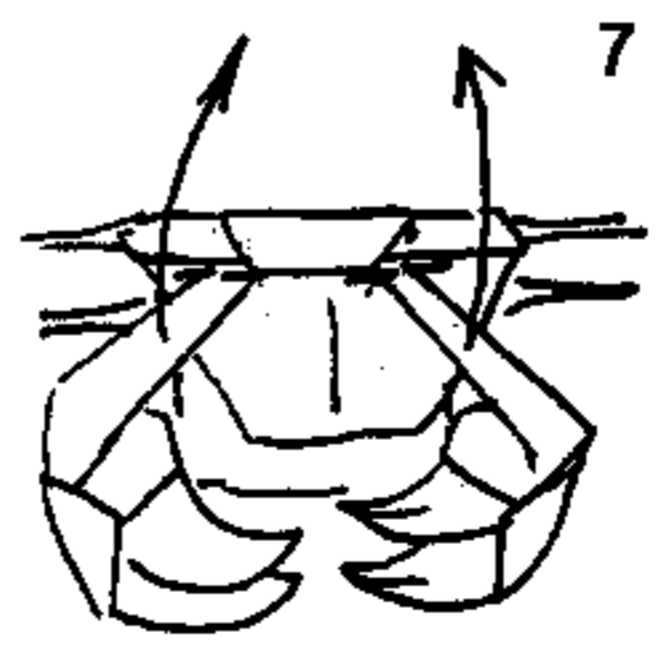
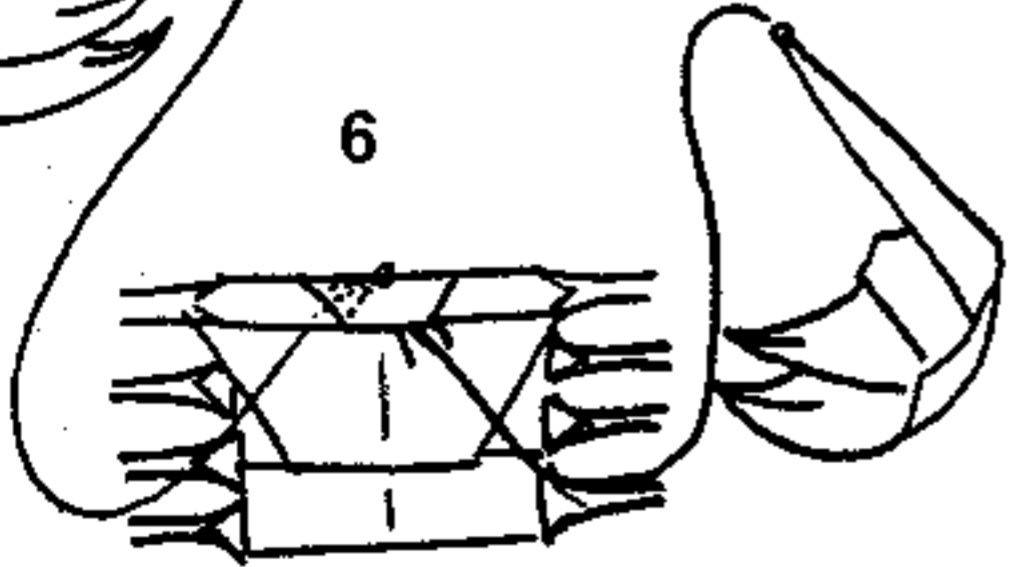
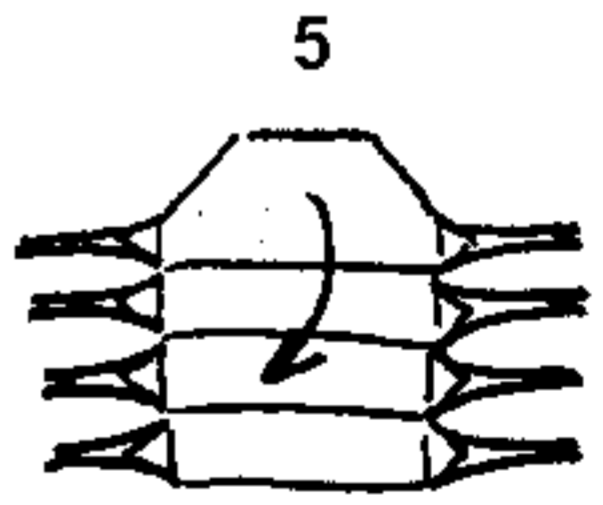

8

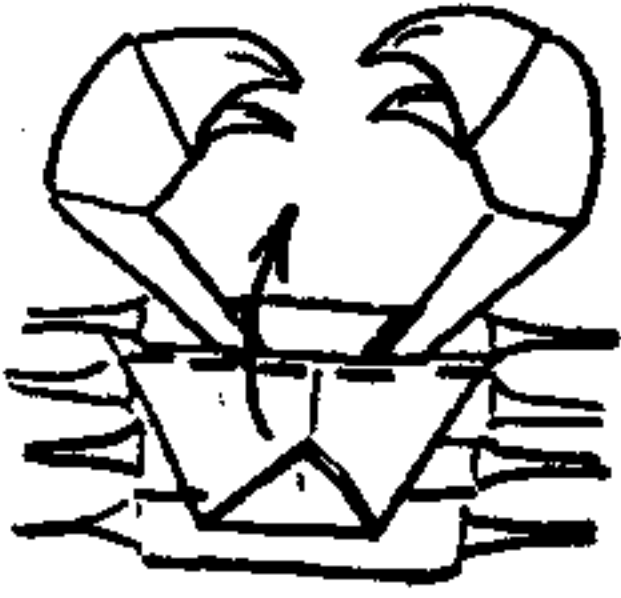

9

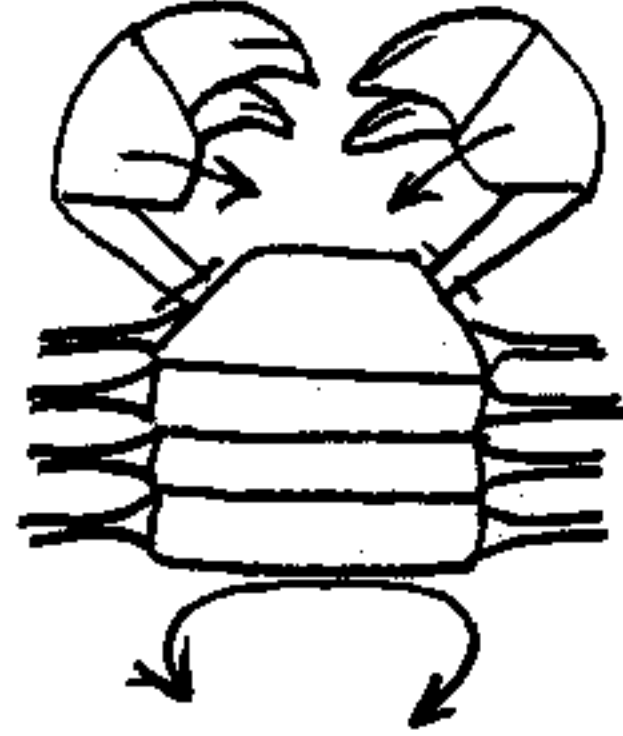

CURVAR EL CUERPO

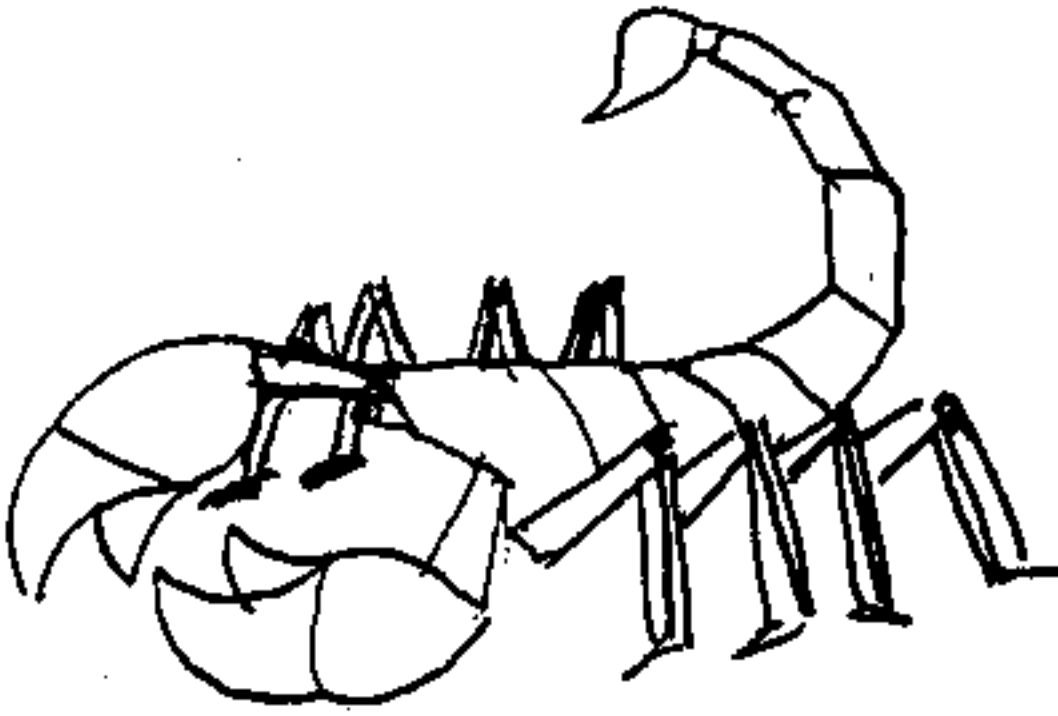

**FIGURA MODULAR
FORMADA CON SIETE
CUADRADOS DE PAPEL
(PAPIROPIEZAS)**

