

① WHITE SIDE UP

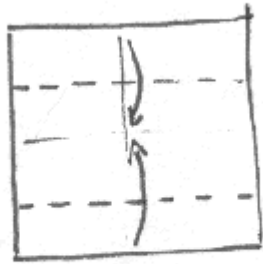

②

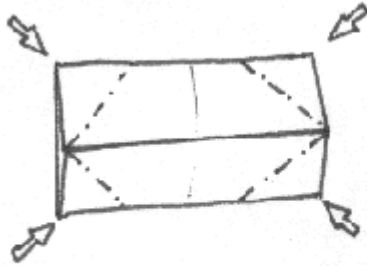

③

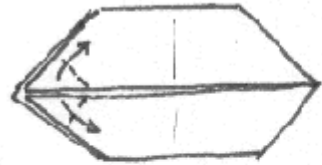

④

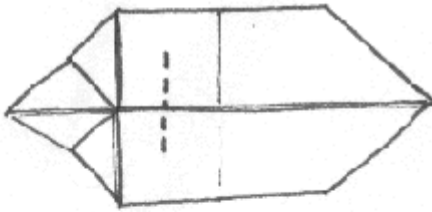

CREASE

⑤

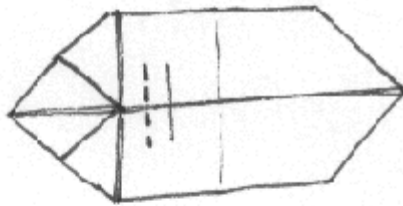

CREASE

⑥

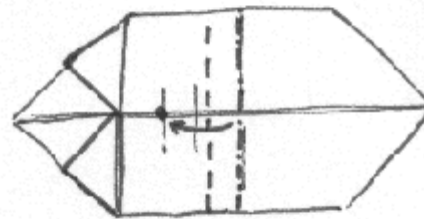

⑦

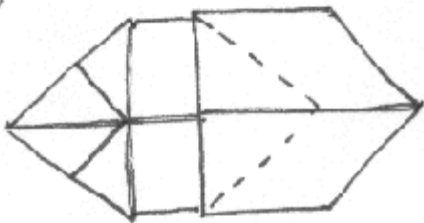

CREASE, TURN OVER

⑧

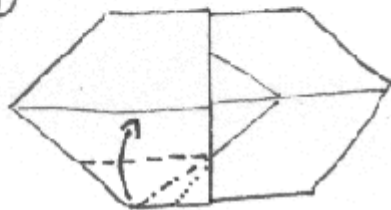

FOLD TO CENTRE LINE

⑨

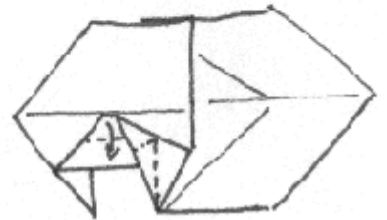

⑩

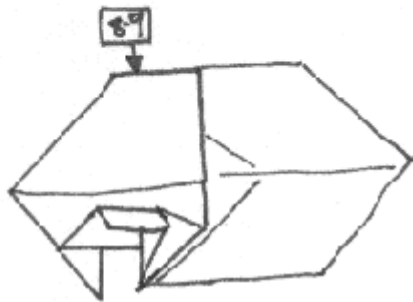

REPEAT STEPS 8-9 ON TOP

⑪

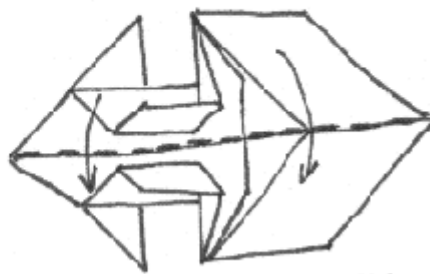

FOLD MODEL IN HALF

⑫

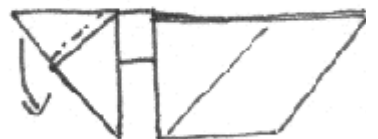

⑬



REVERSE FOLDS TO FORM REAR LEGS & TAIL

⑭

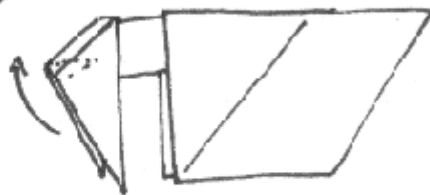

⑮

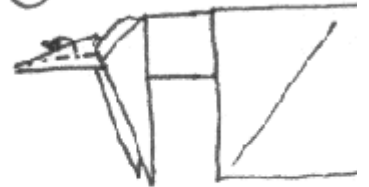

NARROW TAIL

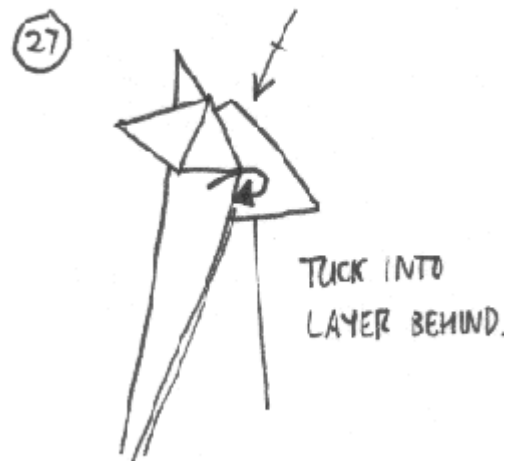
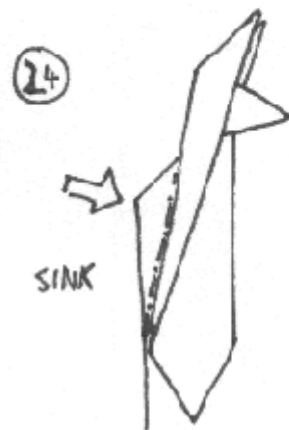
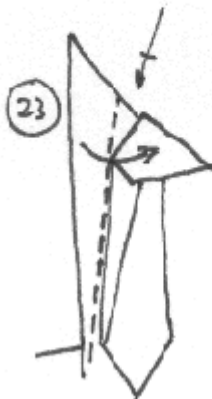
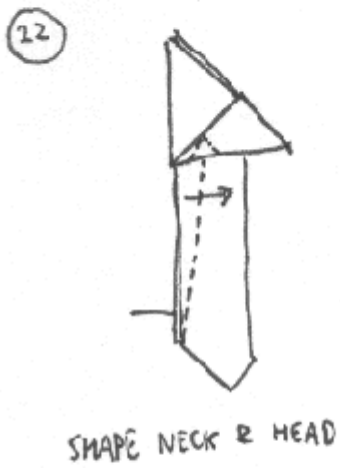
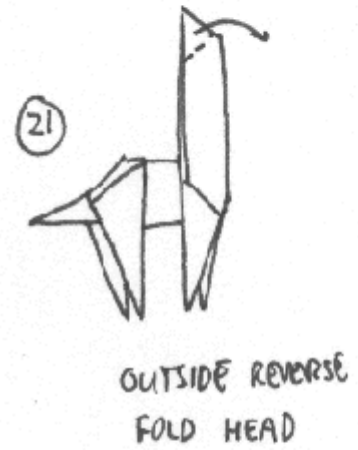
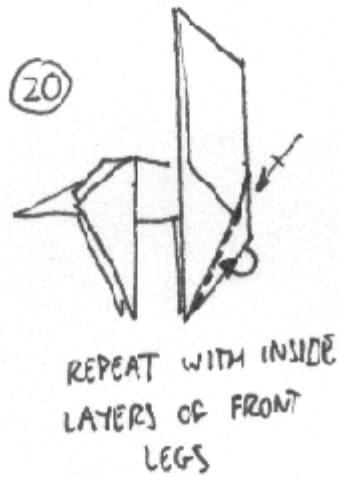
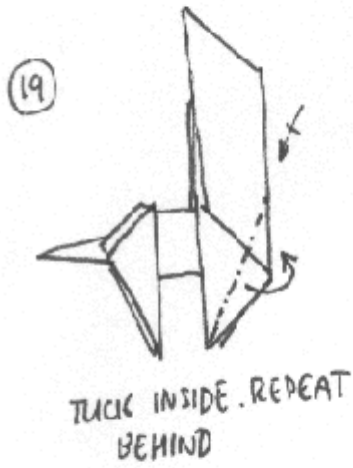
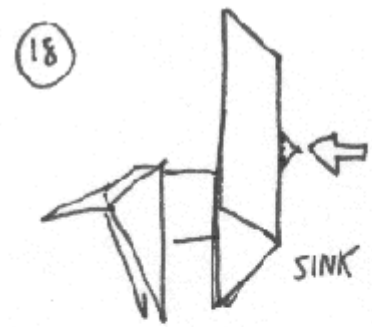
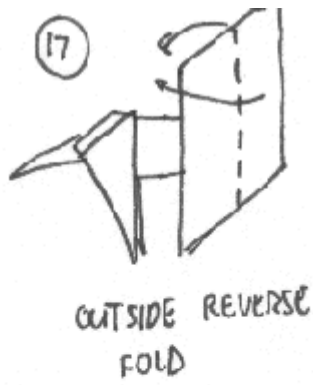
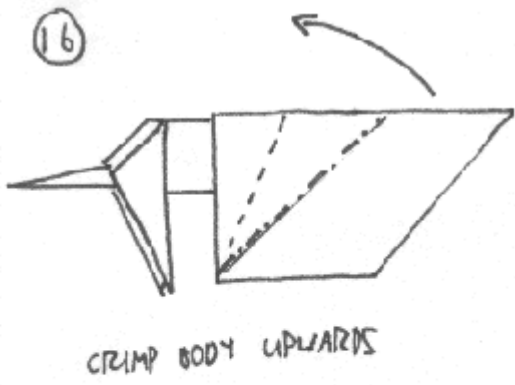

28



...LIKE SO

29

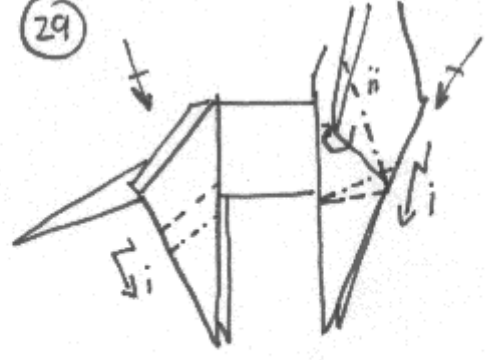

i SHADE LEGS
 ii TUCK INSIDE

30 FINISHED GIRAFFE

