

PEGASO/PEGASUS (Marzo,2004)

Autor/Author: Angel Soto (airsoto@yahoo.com)
Diagramas/diagramed by: Angel Soto

1. Formar base preliminar. (fold nreliminar base)

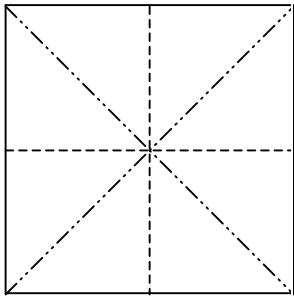

2. Pliegues en valle para formar base pájaro. (Make valley folds to center line. Repeat behind)

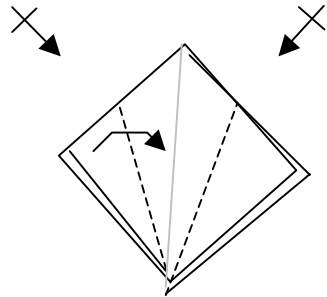

3. Formar base pájaro. (fold bird base)

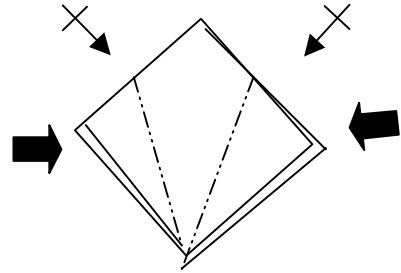

4.

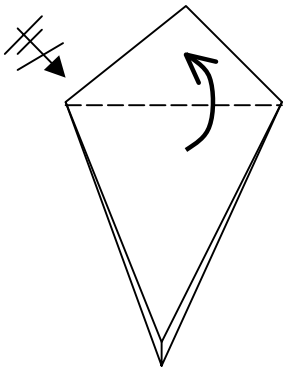

5.

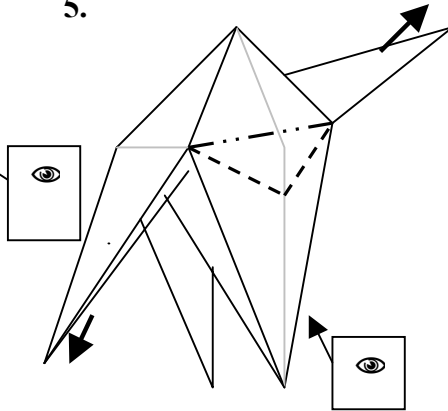

6.

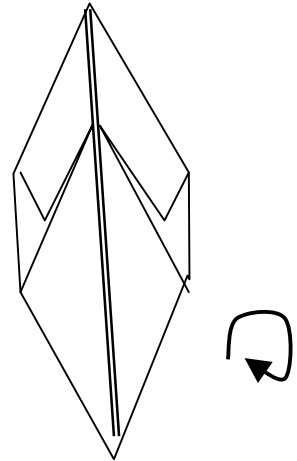

7.

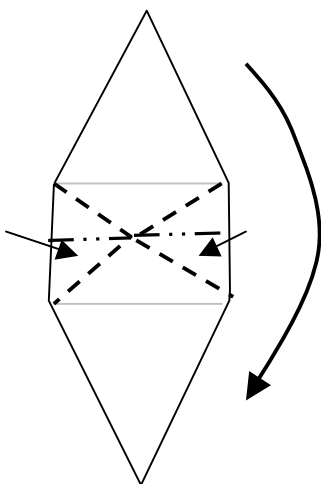

8. Subir la punta de abajo (fold the lower point)

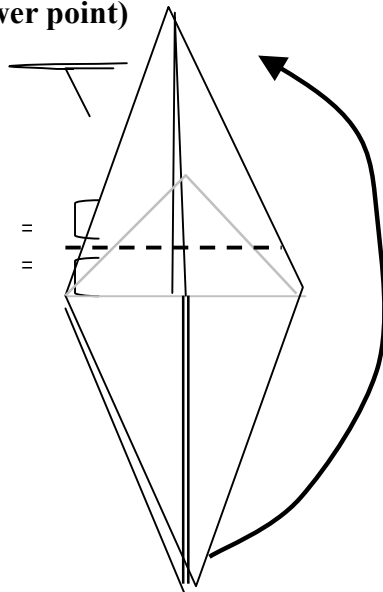

9.

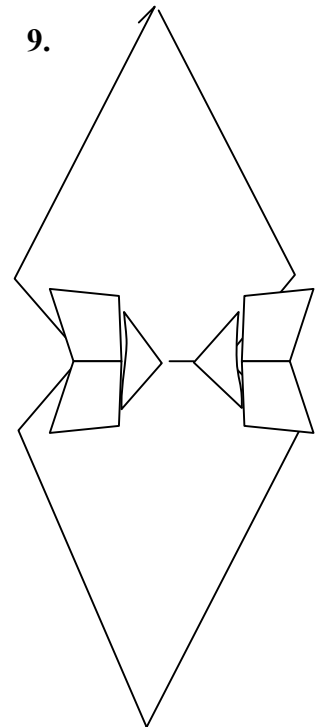

10.

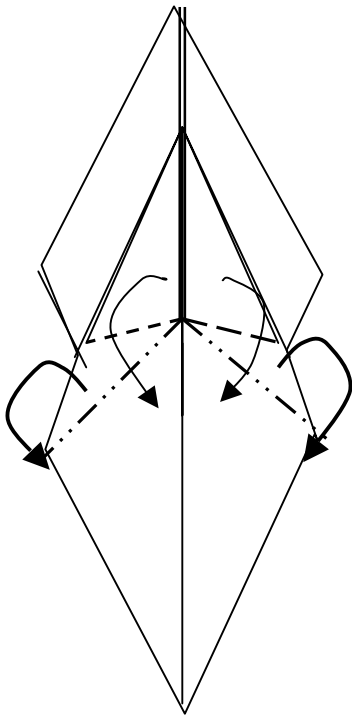

11.

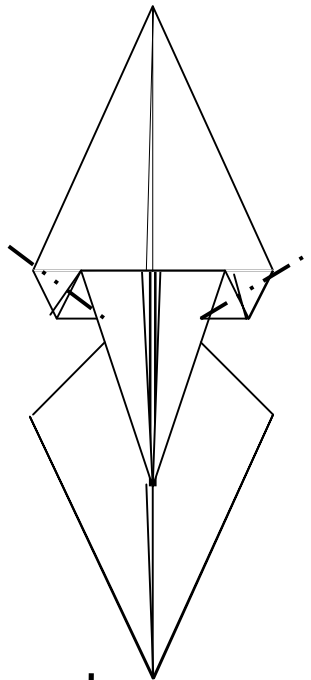

12.

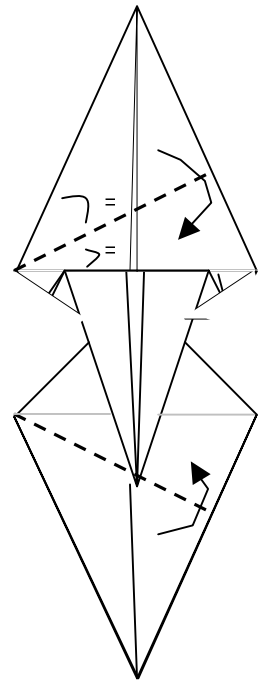

13.

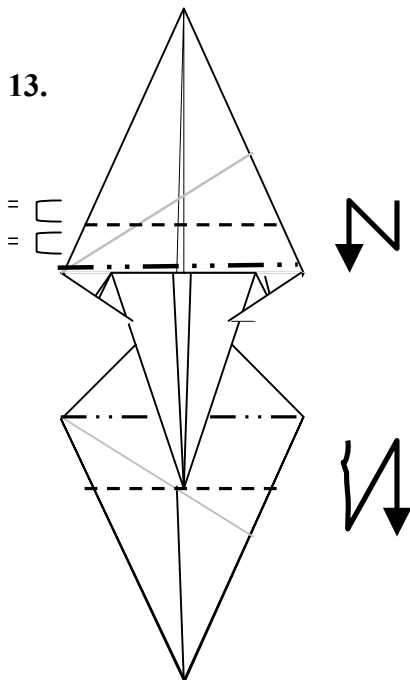

14. Doblar en monte y girar modelo.
(mountain fold along centre line. Mountain folds on the four points to make the legs)

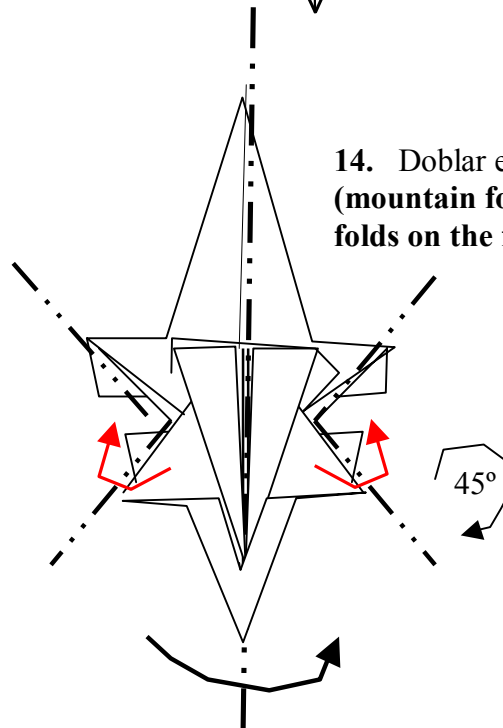

15. Pliegues en monte para adelgazar la punta
(Mountain fold, repeat behind)

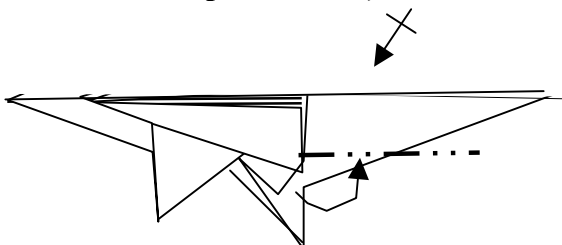

16. Abrir la punta para formar las alas. (Open the wings using the pocket. Repeat behind)
See details in step 16 a

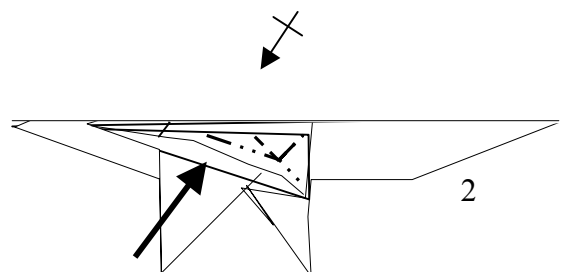

16 a:

Abrir ala por el bolsillo interior y aplastar por base, dando forma a las ala. **(Open the pocket and squash the wing base. Repeat behind)**

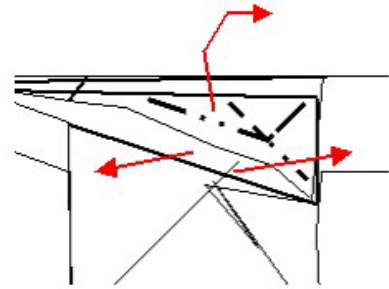

17. Dar forma a las alas.

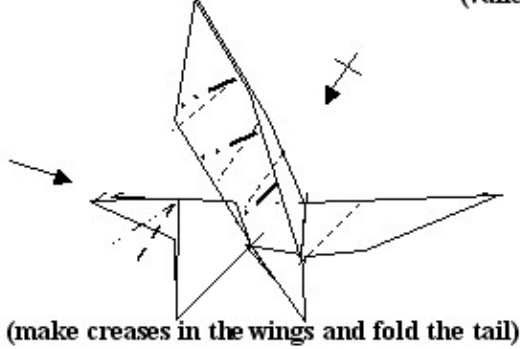

(make creases in the wings and fold the tail)

18. Pliegue invertido para formar la cabeza. Hundido en el cuello (valley fold to make head; sink fold)

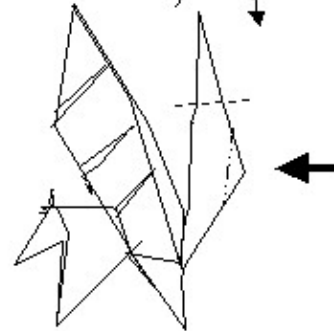

19.

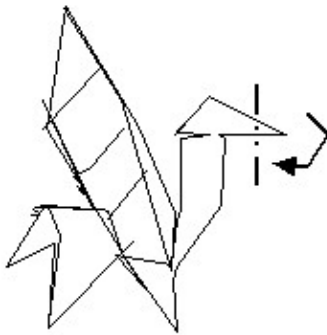

20. PEGASO TERMINADO (PEGASUS FINISHED)

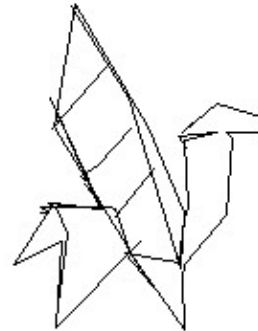

*Modelo dedicado a mi abuela.
Dedicated to my grandmother.*