

CACHALOTE

Por: Daniel F. Naranjo V.

dfnaranjo@hotmail.com

Esta hermosa ballena destaca por su robusta cabeza. Puede alcanzar entre los 15 y 18 metros de longitud. Un noble animal, con pocos enemigos naturales. Este gigante del océano tiene entre sus principales depredadores a su pariente cercano la orca, que en grupos de diez o doce le dan cacería.

A partir de la otra figura, la ballena azul (aún no diagramada) surgieron la idea y los diagramas para esta.

Hoja cuadrada, puede ser de dos colores dando como resultado una ballena como la de la foto.

Una hoja cuadrada de 15 cms produce una figura de 14 cms de largo. Nivel: intermedio simple.

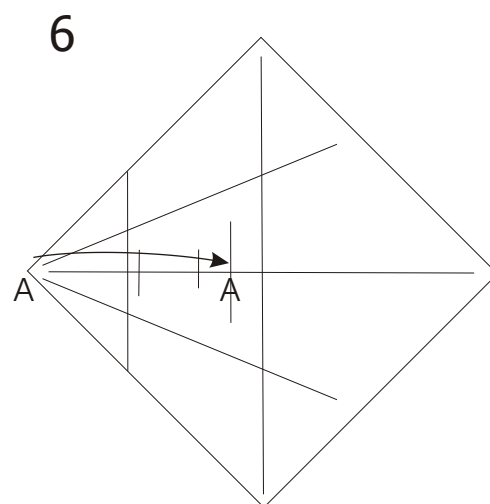
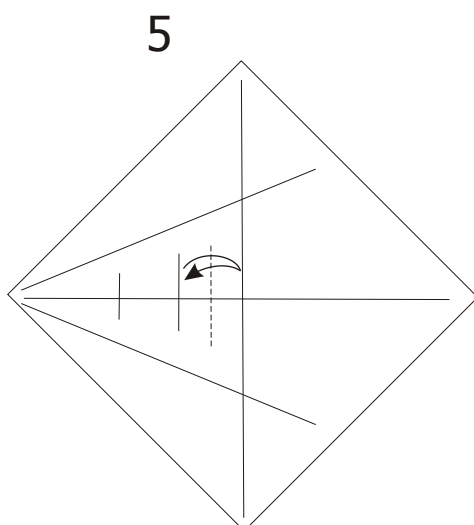
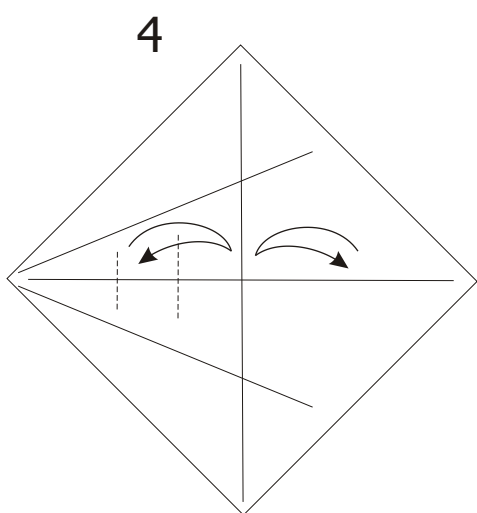
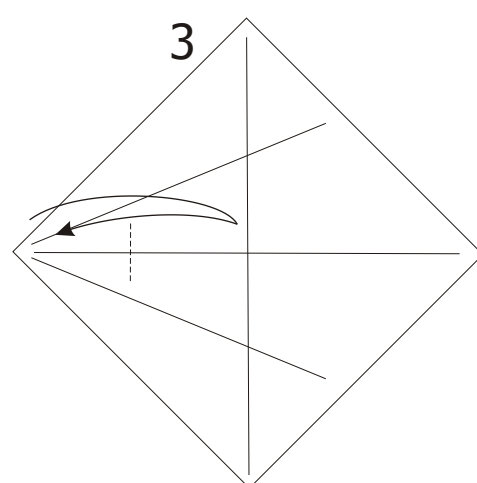
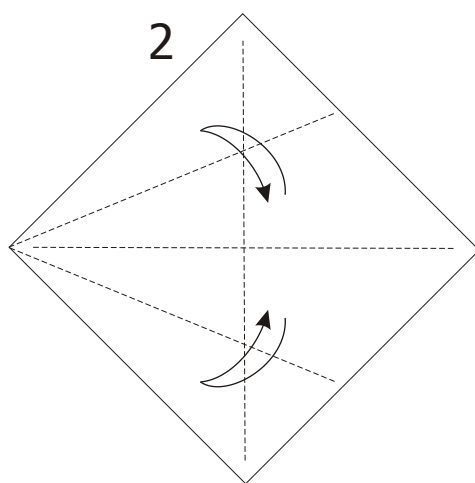
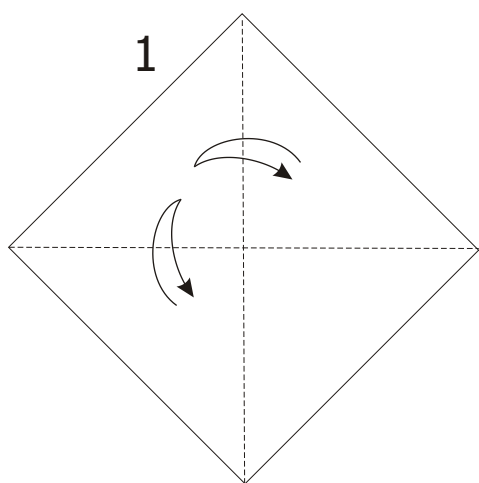

Unimos las dos partes marcadas como A

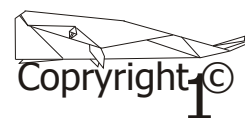

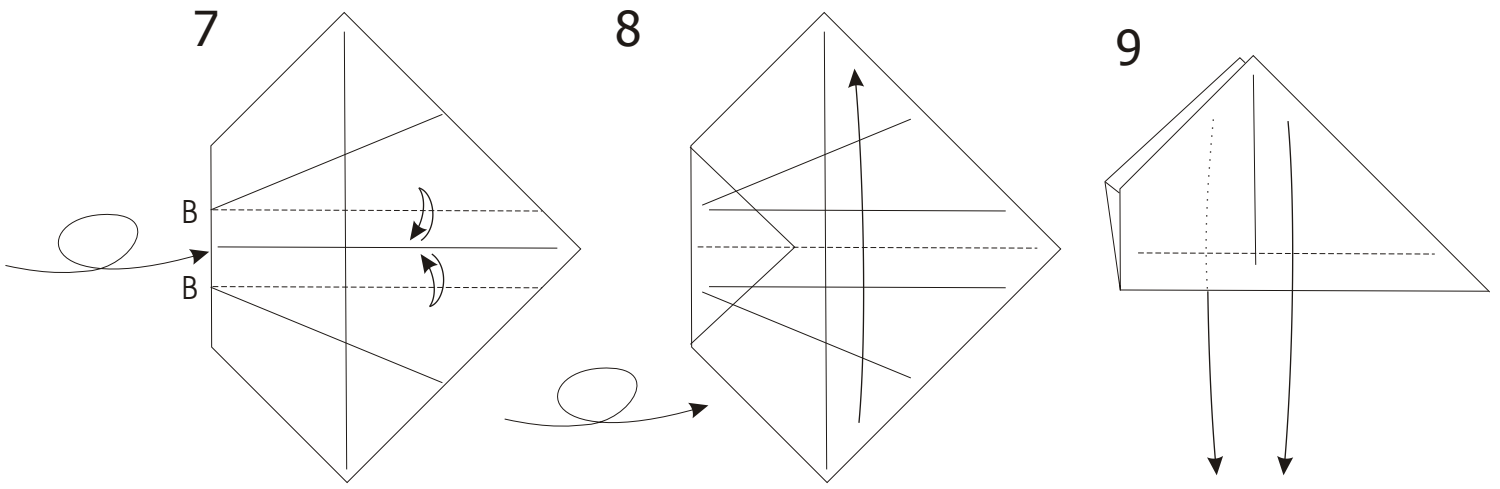

Marcamos los puntos B y por ellos las paralelas a la diagonal.

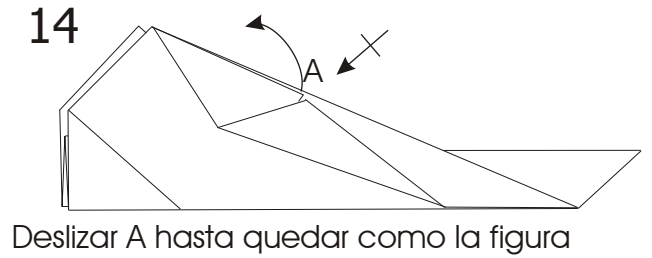
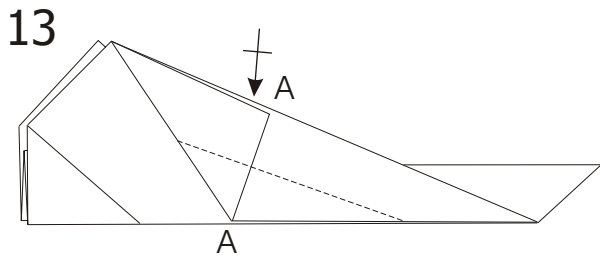
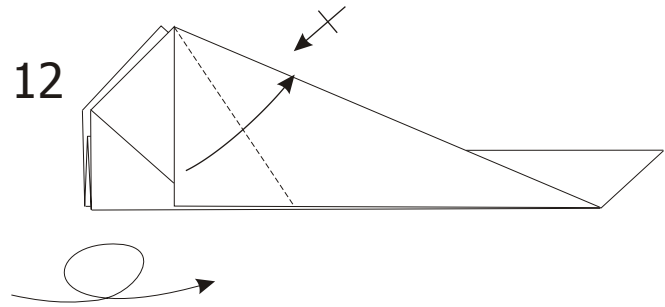
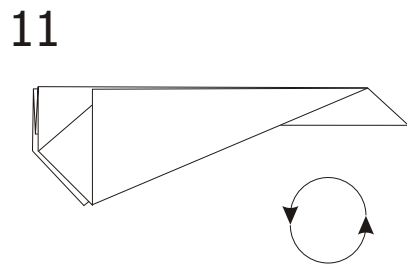
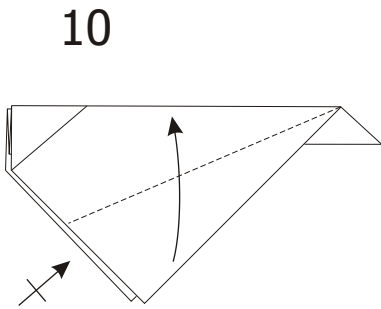

Deslizar A hasta quedar como la figura

Unimos las dos partes marcadas como A

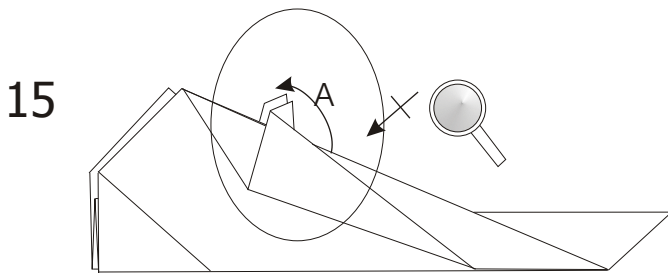

Deslizar hasta quedar como la figura

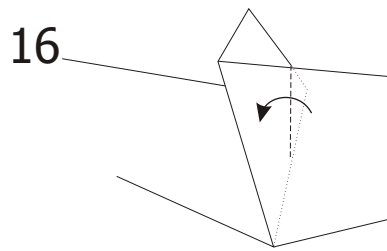

Realizar este dobléz en la parte interior, por los dos lados

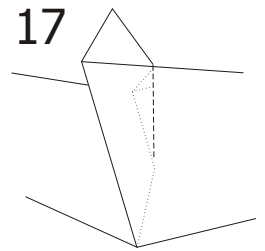

18

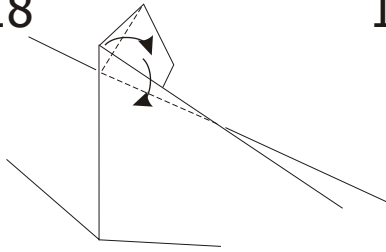

19

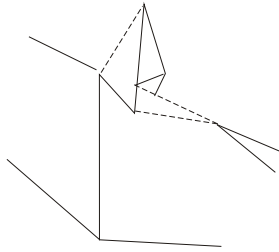

20

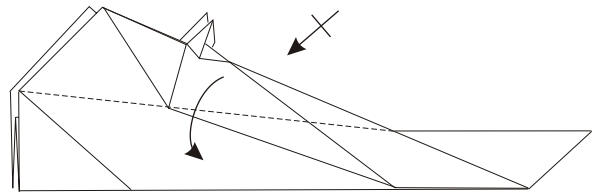

21

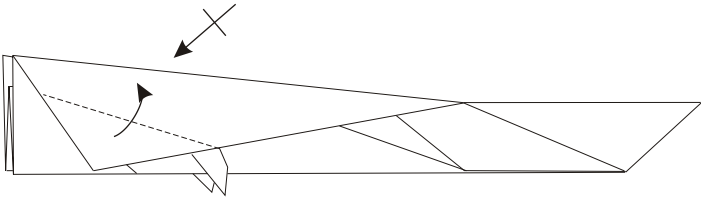

22

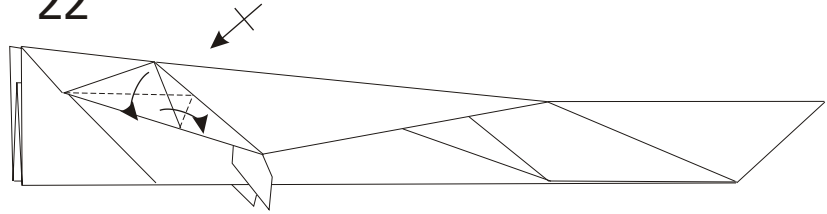

23

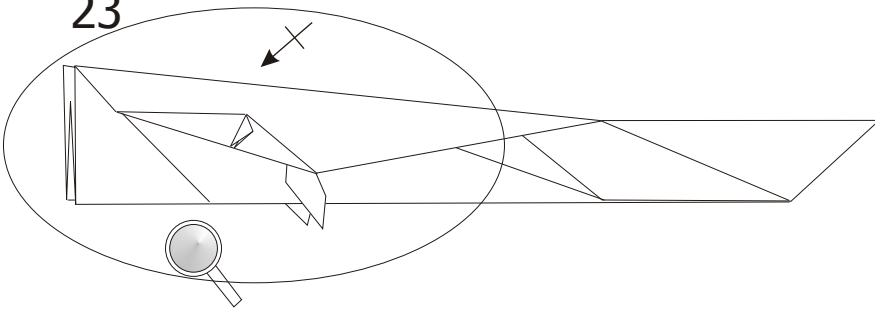

24

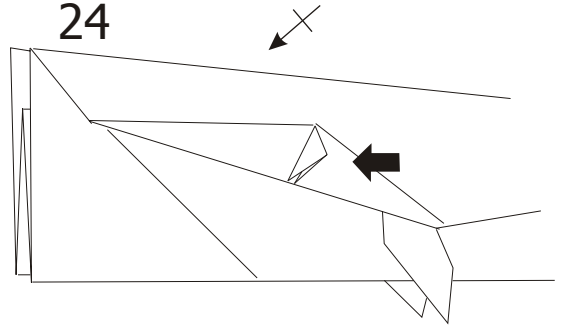

25

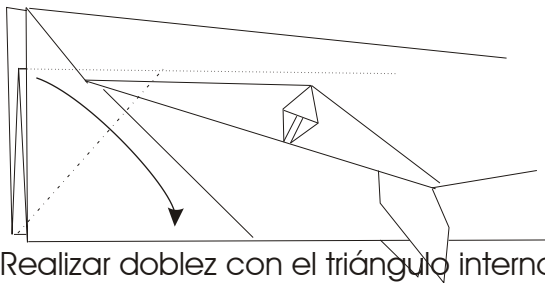

Realizar dobléz con el triángulo interno...

26

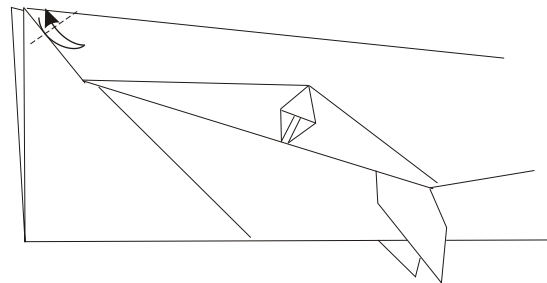

27

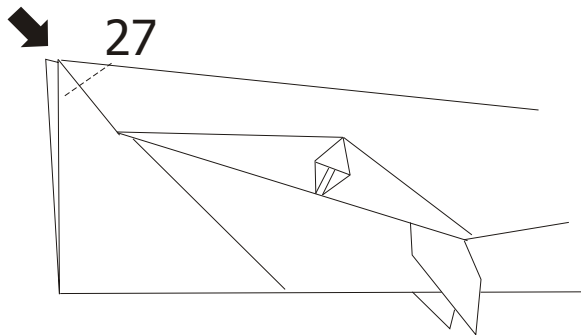

28

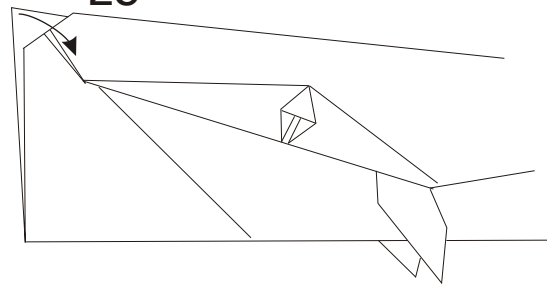

Introducir en este lado



29

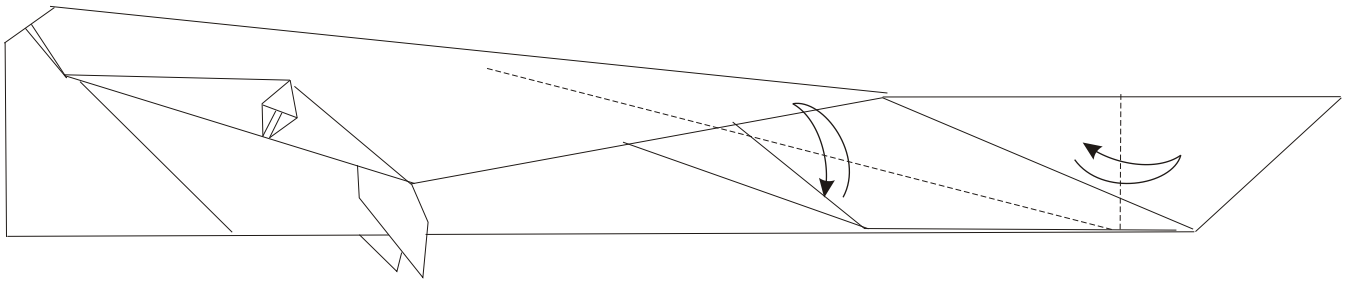

30

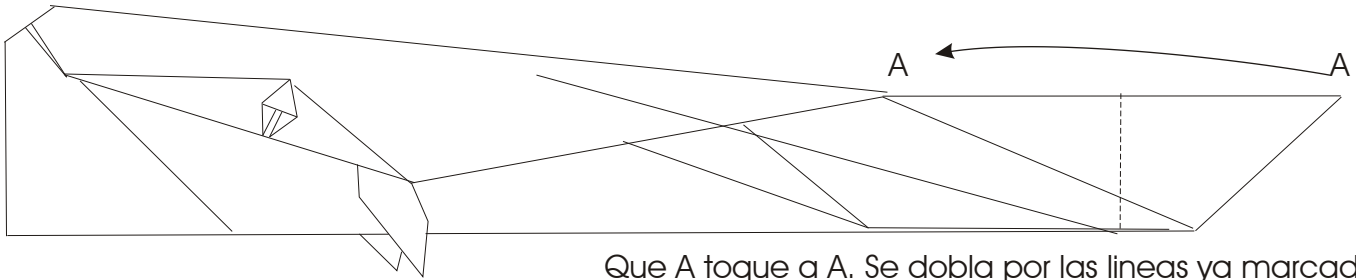

Que A toque a A. Se dobla por las líneas ya marcadas...

31

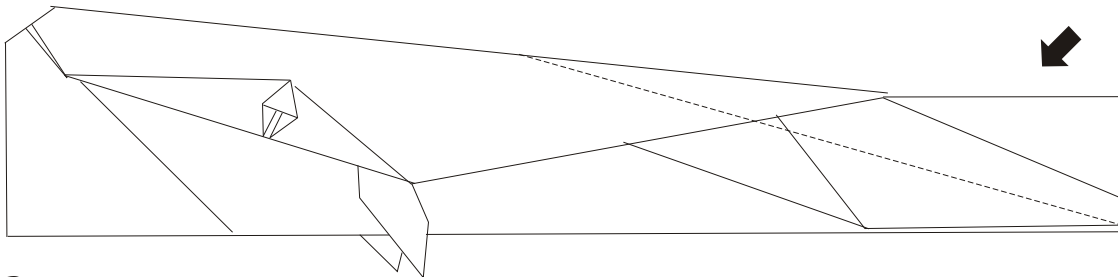

32

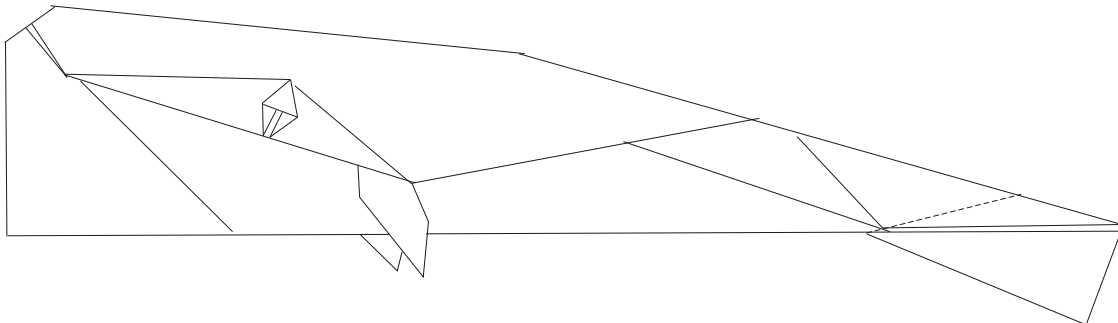

33

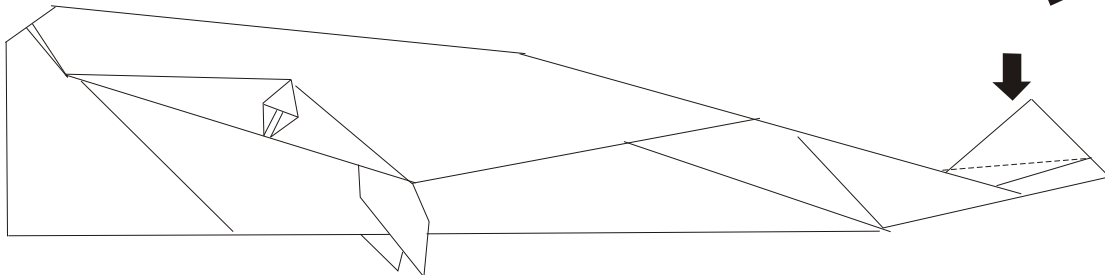

34

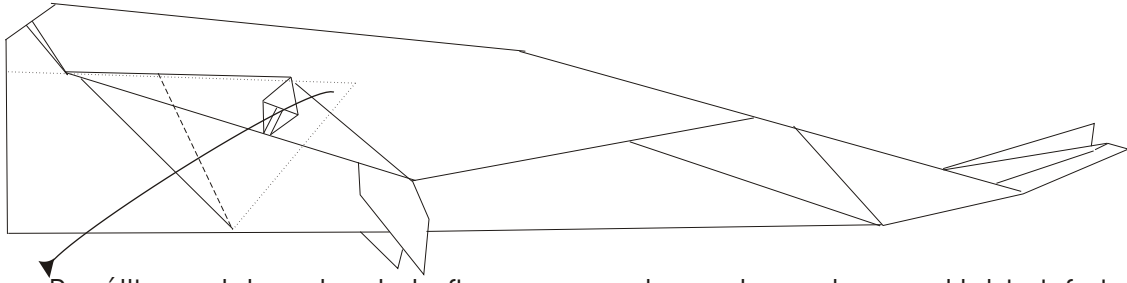

Por último, del centro de la figura sacar el papel para hacer el labio inferior.

35

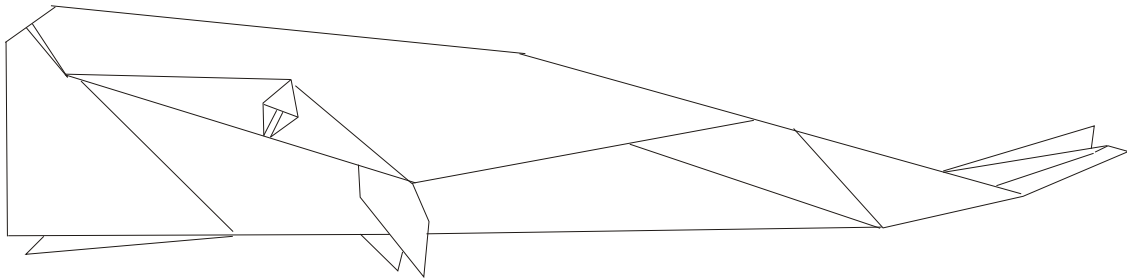

Es posible dar un poco de forma y enrollar la cola...
Con eso el cachalote queda terminado...

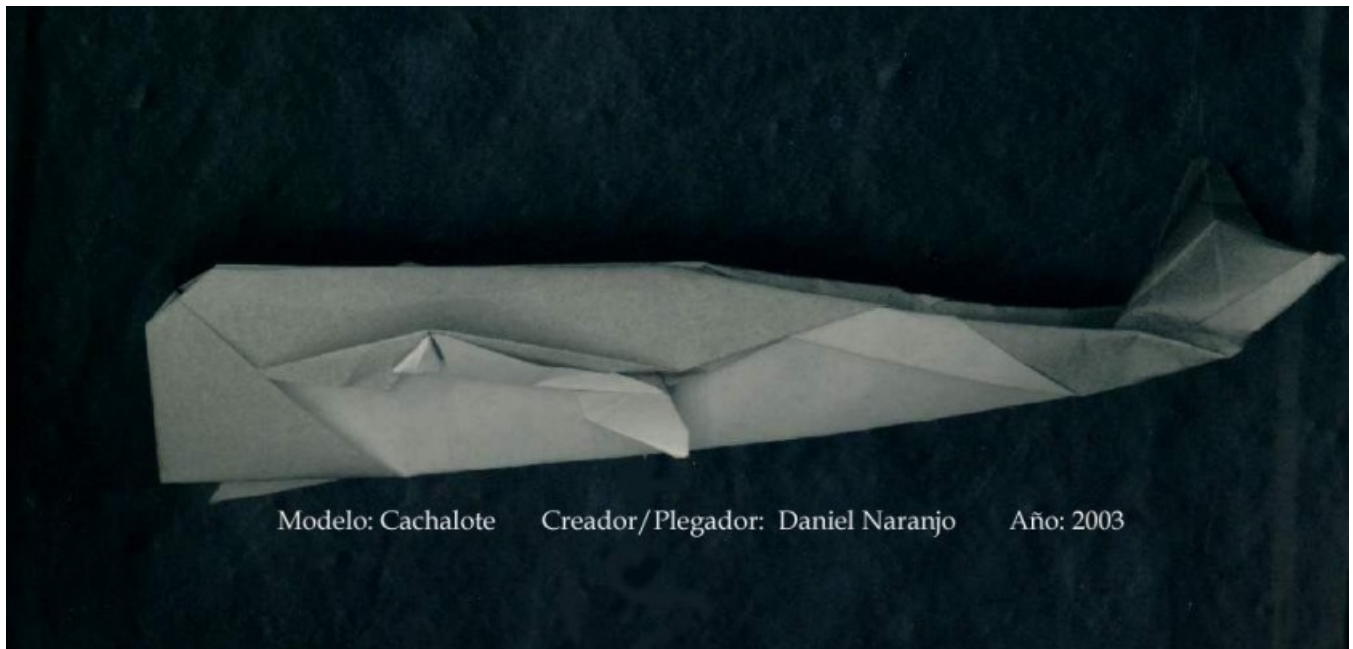

Modelo: Cachalote Creador/Plegador: Daniel Naranjo Año: 2003

