

料理長のお薦め品

EUNIAKY KAWAHATA  
ワニ (その1)

作・図 川畑 文昭

≒ 2/3 ㊦

MUY BUENO 10.

3D

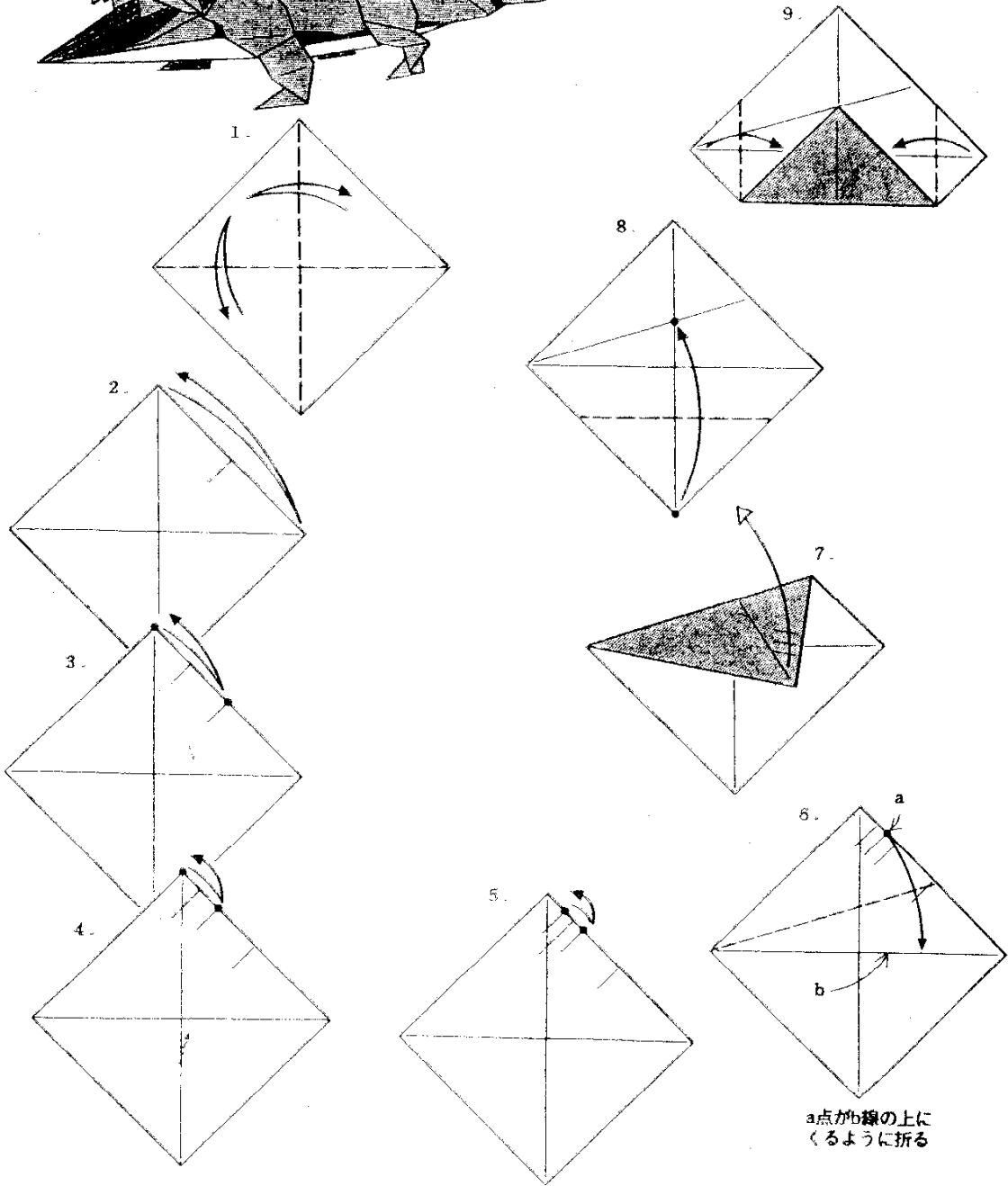
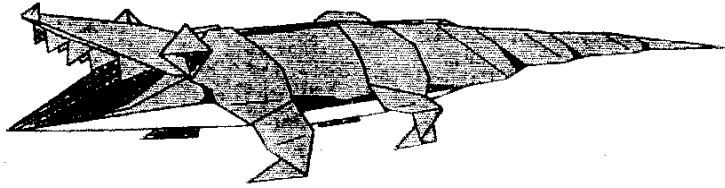
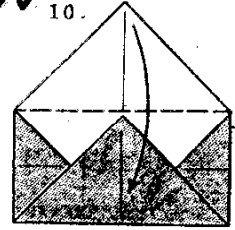

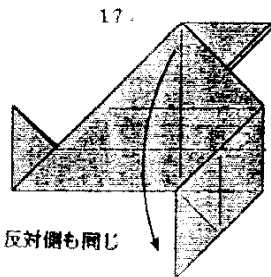
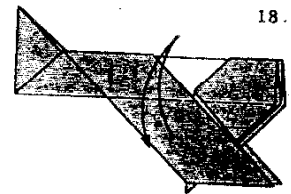
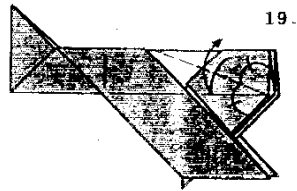
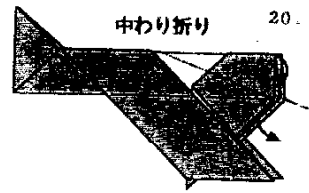
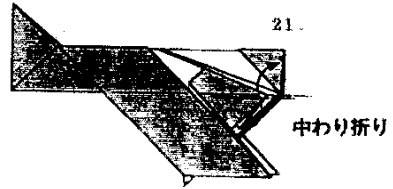
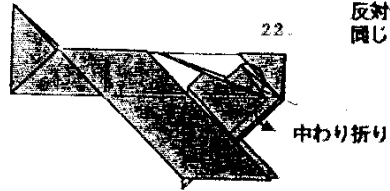
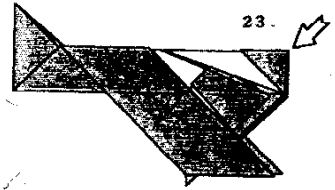
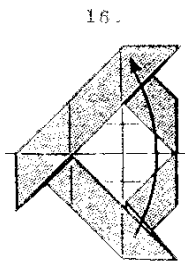
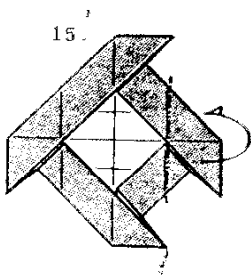
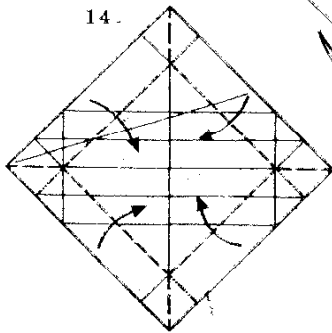
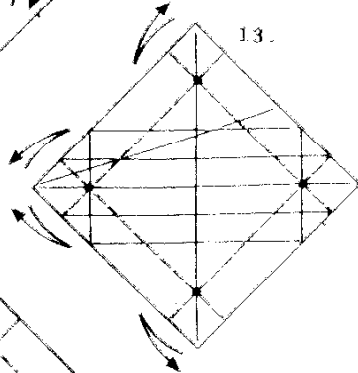
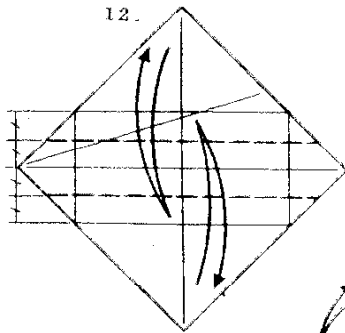
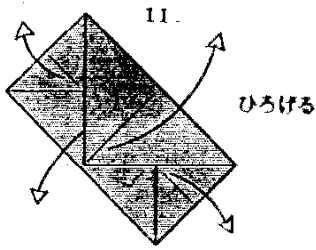

反対側も19~22までと同じに折る

中わり折り

中わり折り

中わり折り

反対側も同じ

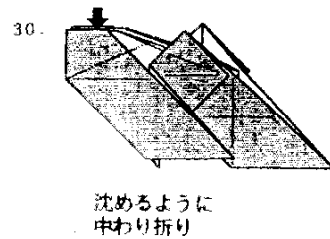
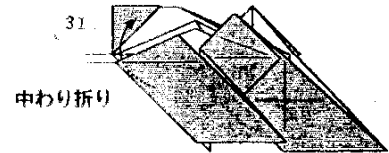
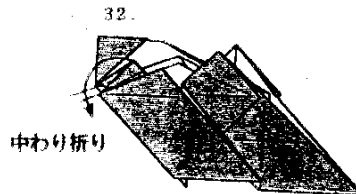
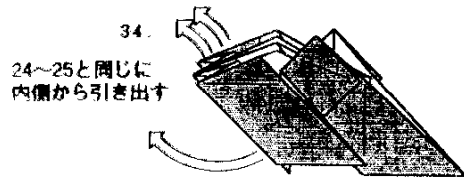
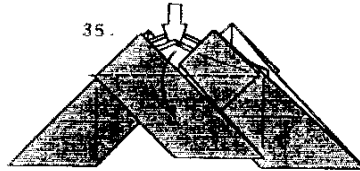
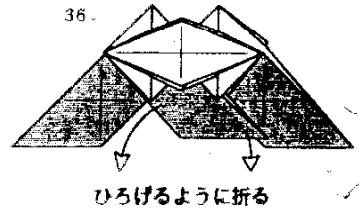
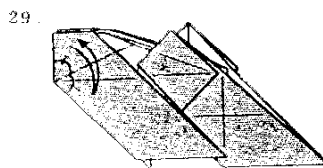
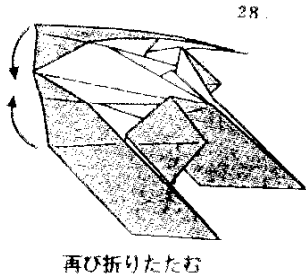
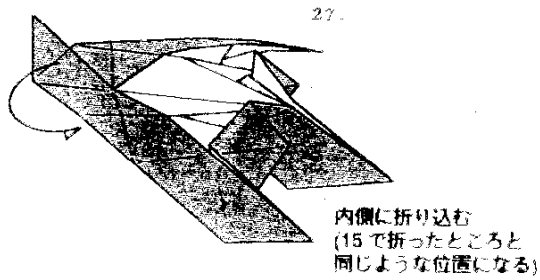
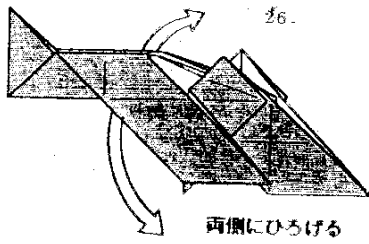
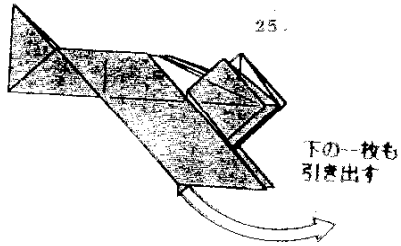
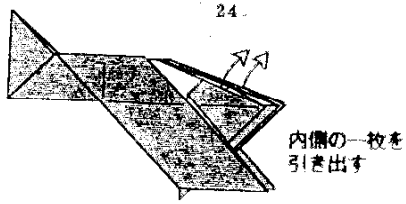

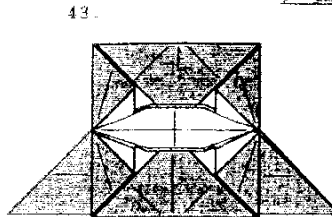
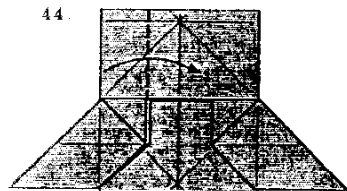
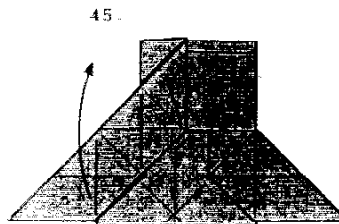
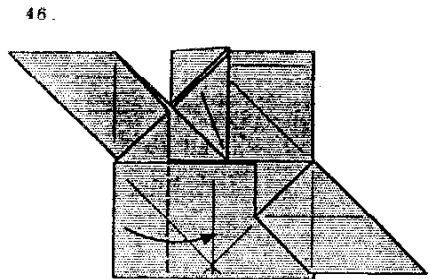
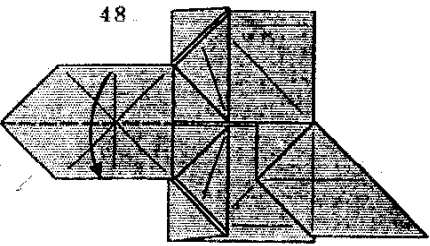
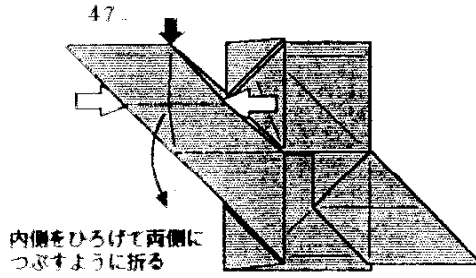
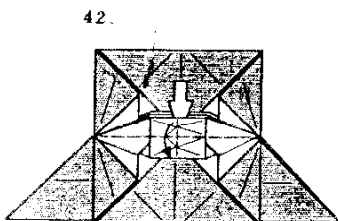
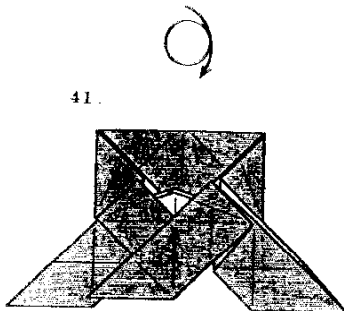
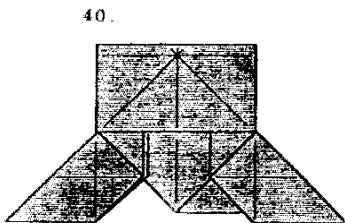
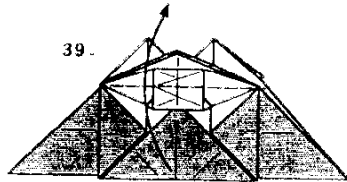
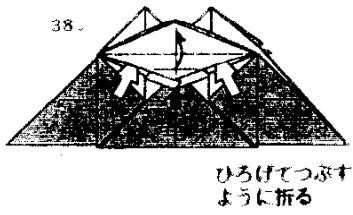
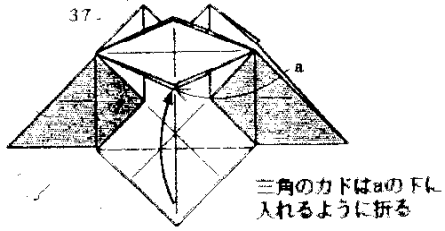

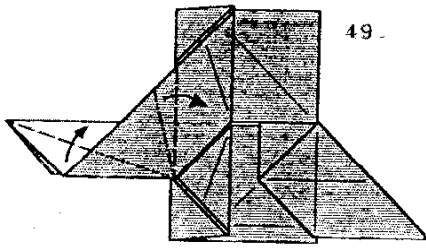

49.

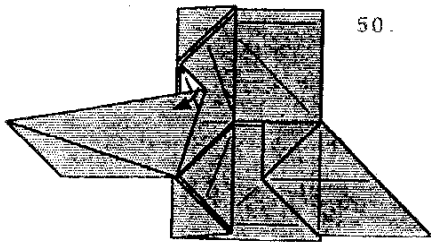

50.

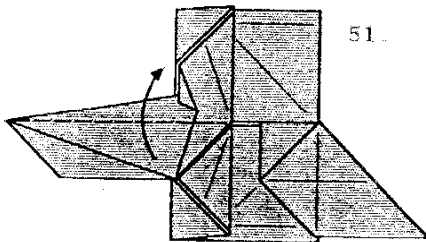

51.

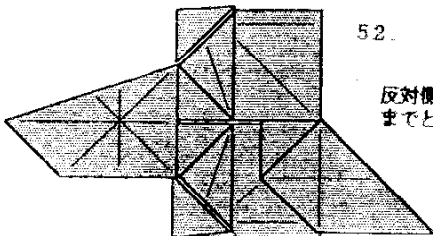

52.

反対側も48~51  
までと同じに折る

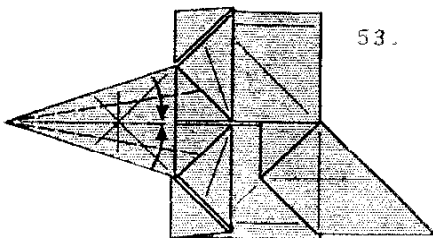

53.

右側も59~62と  
同じに折る

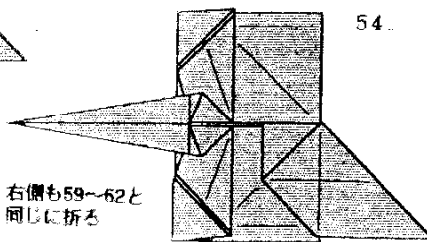

54.

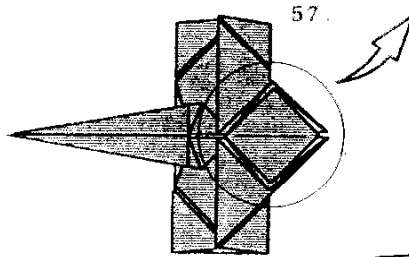

57.

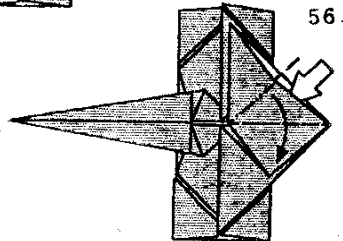

56.

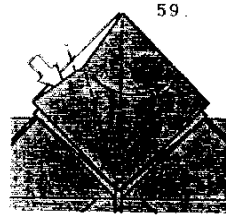

59.

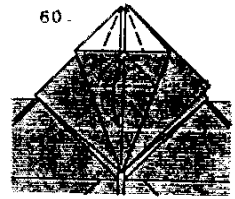

60.

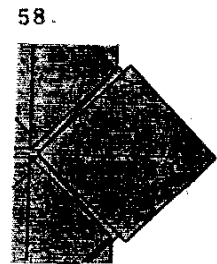

58.

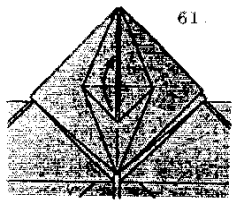

61.

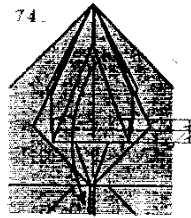

74.

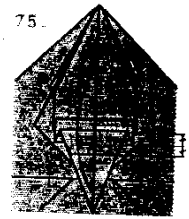

75.

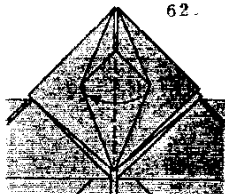

62.

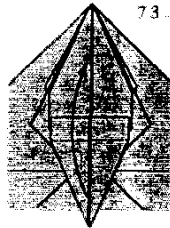

73.

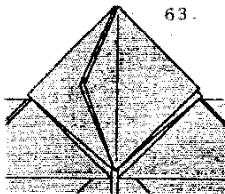

63.

右側も44~46の  
手順で折る

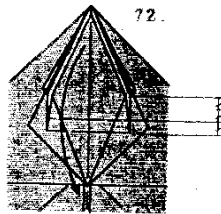

72.

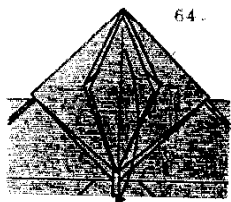

64.

下の方に  
大きく引き下げる

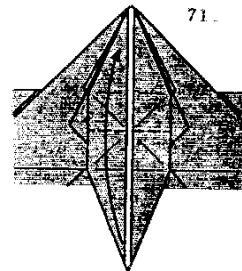

71.

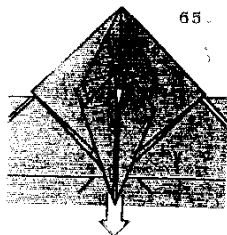

65.

途中の図

右側も66~69と  
同じに折る

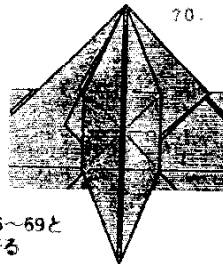

70.

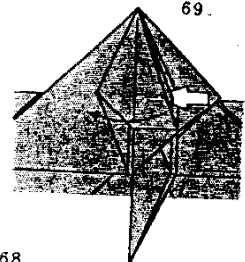

69.

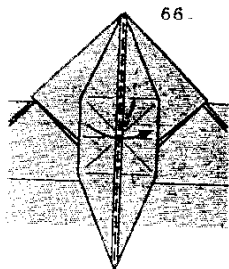

66.

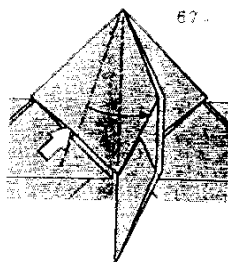

67.

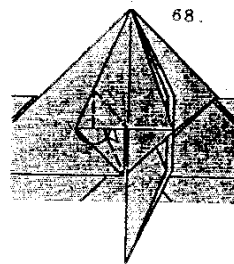

68.

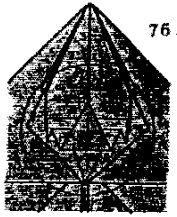

76.

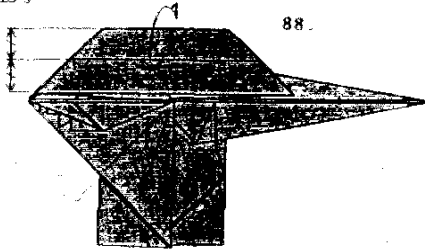

88.

以下次号

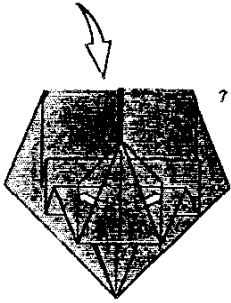

77.

裏面から  
ずらすように  
して引き出す

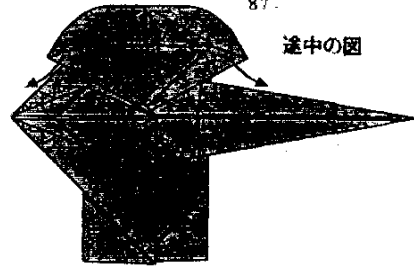

87.

途中の図

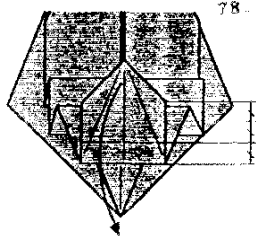

78.

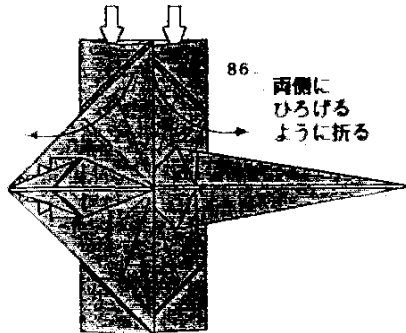

86.

両側に  
ひろげる  
ように折る

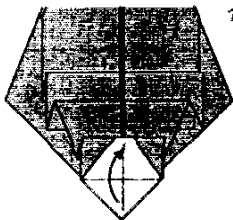

79.

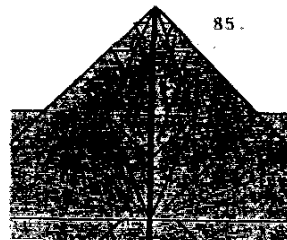

85.

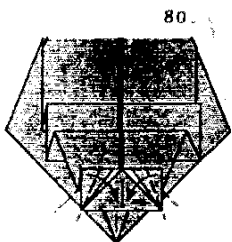

80.

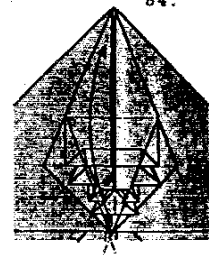

84.

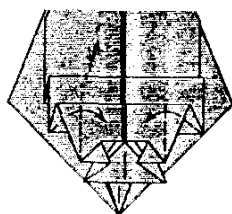

81.

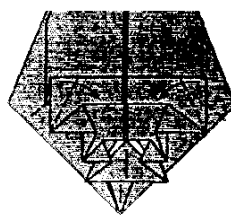

82.

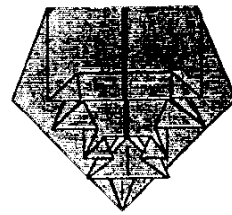

83.

# 料理長のお薦め晶

## ワニ その2

作・図 川畑文昭

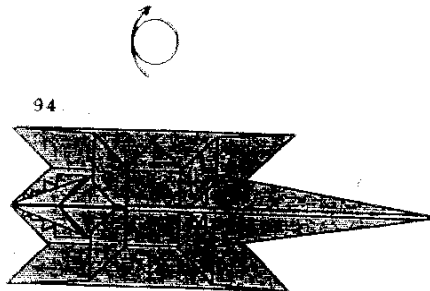
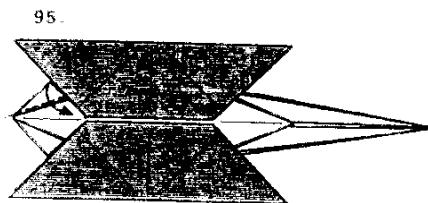
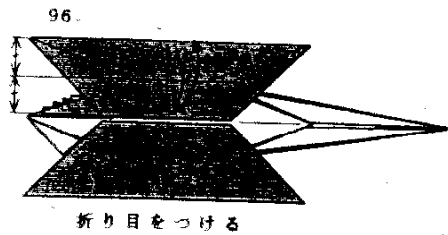
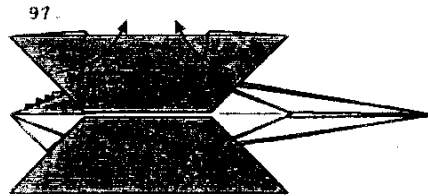
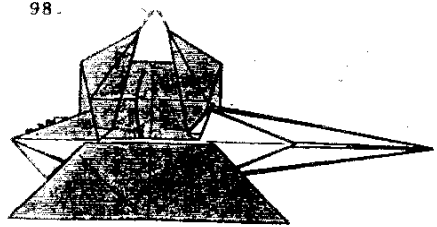
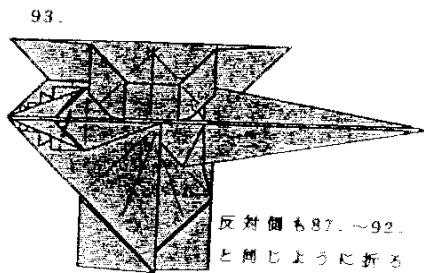
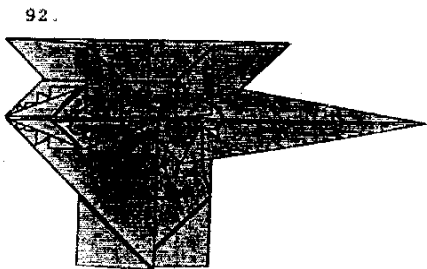
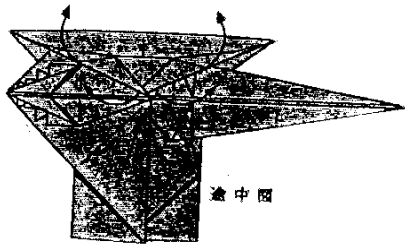
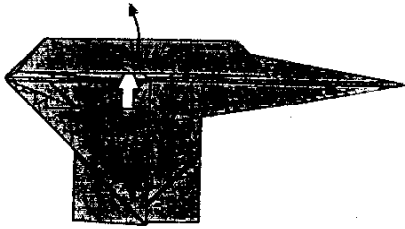



99.

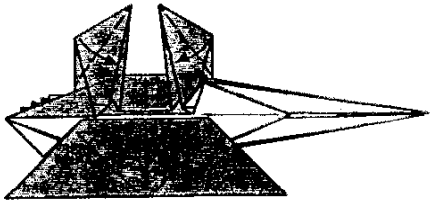

108.

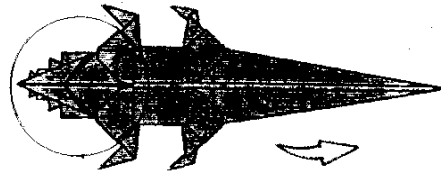

100.

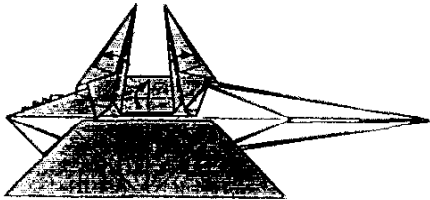

107.

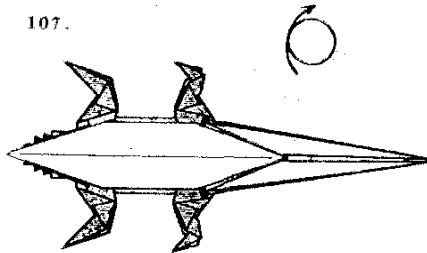

101.

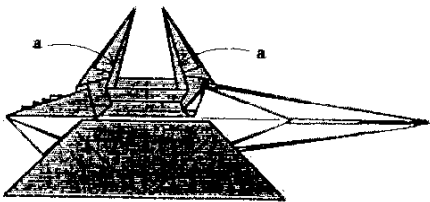

106.

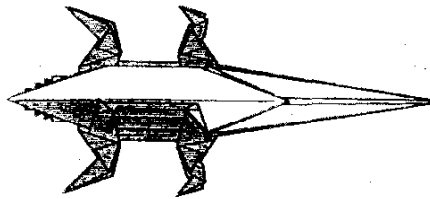

a の部分を下に入れる

反対側も105.と同じ

105.

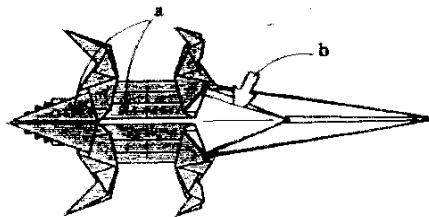

102.

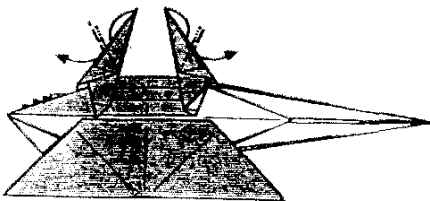

a の部分を b の中に入れる

中わり折り

104.

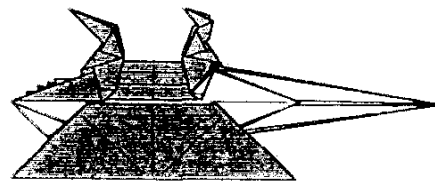

反対側も95.~103.までと同じように折る

103.

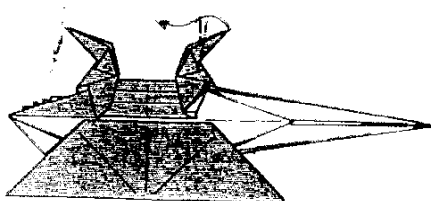

中わり折り

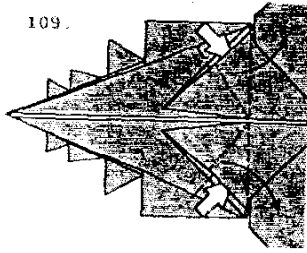

109.

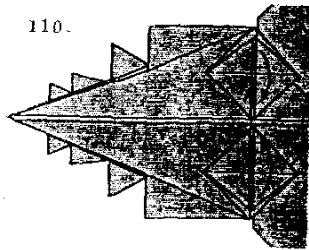

110.

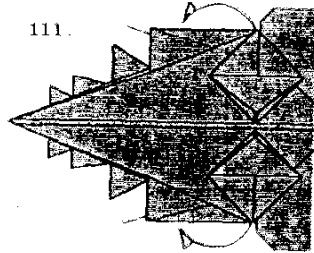

111.

内側の一枚を中わり折り

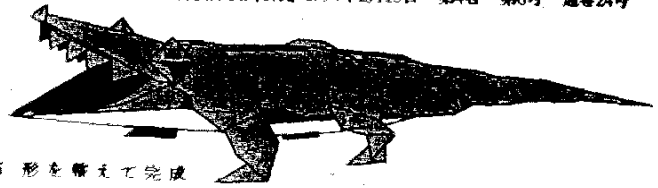

115 形を整えて完成

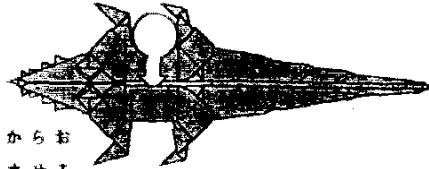

114.

背中のすきまからお  
なかをふくらませる

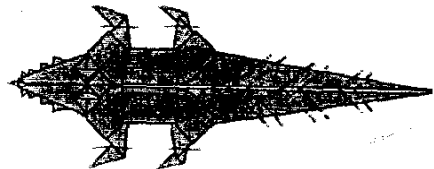

113.

足と尾を折る

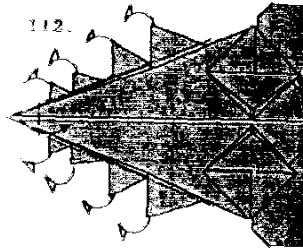

112.

## 第二回折り紙の科学と科学的折り紙国際会議

折り紙が、幾何学や代数学と深い関わりがあることに、関心をお持ちの方はこの探偵団新聞の読者の中にもかなりの数おられることだろう。折り紙が数学理論や工学の分野に入り込んだり、逆に科学や数学が折り紙のアートに新しい手法を切り開いたりしている。近年のこのような状況を背景として、1989年12月にイタリアのフェラーラで第一回目の国際会議が開催された。そして、本年11月に「第二回折り紙の科学と科学的折り紙国際会議」が日本で開催されることとなった。

滋賀県大津市に設立された新しいかたちの造形大学を目指す成安造形大学が、この会議を企画・主催して行われる。世話人としては「三浦折り」で知られる三浦公亮東京大学名誉教授やイタリア在住の物理学者藤田文章教授らがあたる。

会議のテーマは多岐にわたるが、例えば  
・折り紙の数理的な、あるいはコンピューターによるデザイン

・自然の形態あるいはその形成と折り紙の関わり

・折り紙とインダストリアル・デザイン

など「折り紙の科学と科学的折り紙に関する、研究あるいは作品」ということになりそうだ。また、この会議の開催に当たり、主催者側では発表希望者を募集している。近日中に正式な案内状が発行される予定であるが、基本的な内容を以下に記しておこう。

場所：成安造形大学

開催期日：11月29日から12月2日

研究発表は、いわゆる講演形式のもとテーブルセッション（自由形式）の二本立て。

発表希望者は、発表内容の要約2ページ（図を含む）を会議事務局に4月30日までに送る。なお、発表内容は提出者のオリジナルに限るが、既発表のものでも良い。希望者は下記に葉書で資料を請求して欲しい。

〒520-02

滋賀県大津市仰木町 成安造形大学「折り紙の科学会議」事務局