

# Eagle (version 2006)

Model created by **Nguyen Hung Cuong**  
Diagrams produced by **Andrey Ermakov**

Recommended size **50-50 cm**

**25.05.2008**

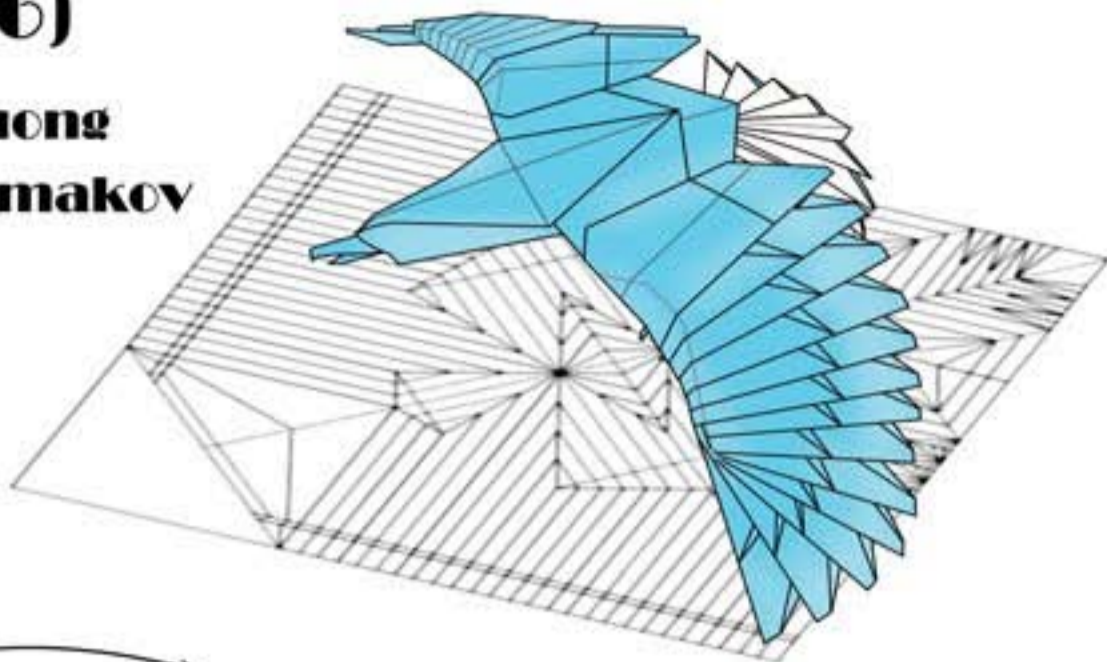

**1**

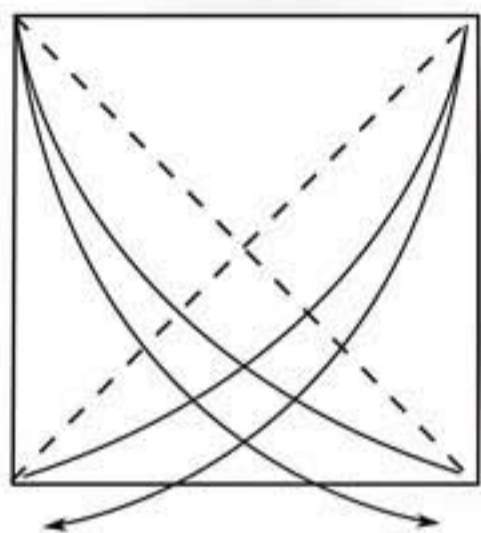

**2**

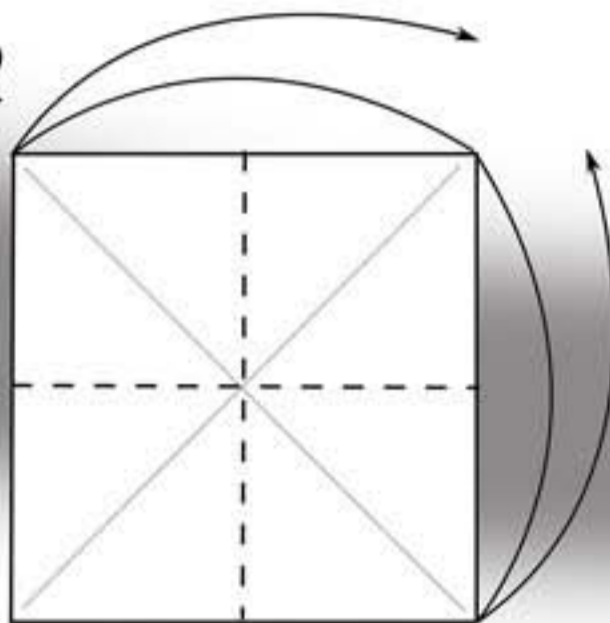

**3**

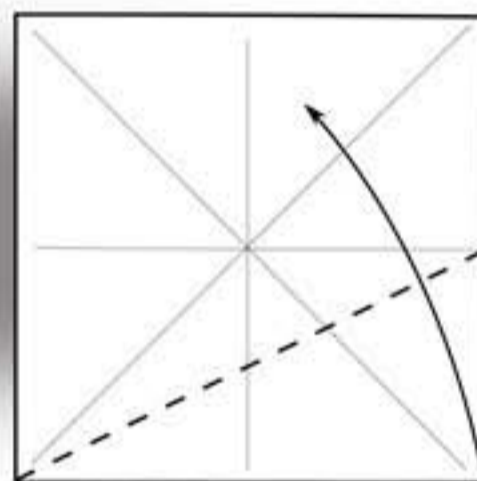

**6**

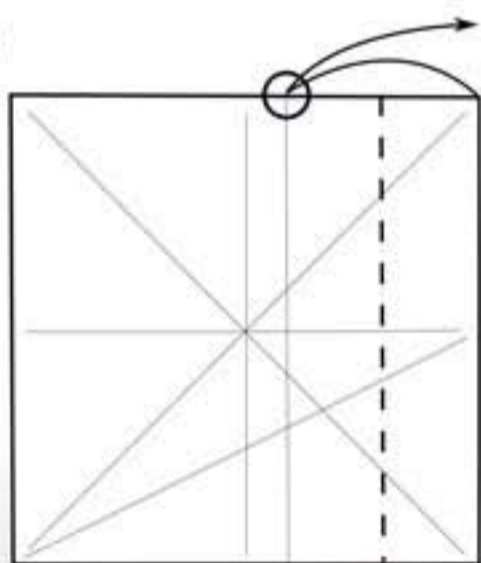

**5**

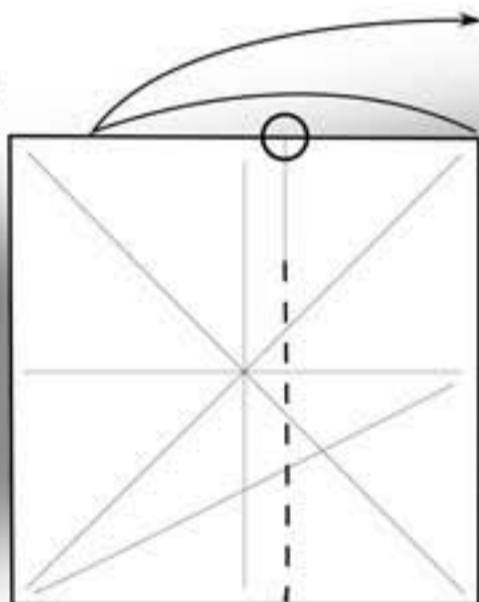

**4**

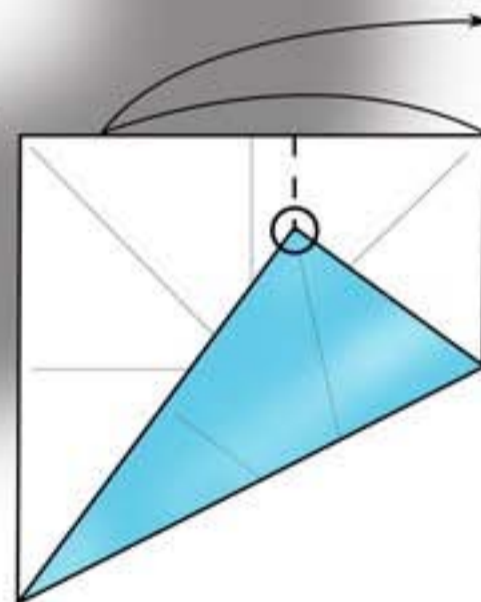

**7**

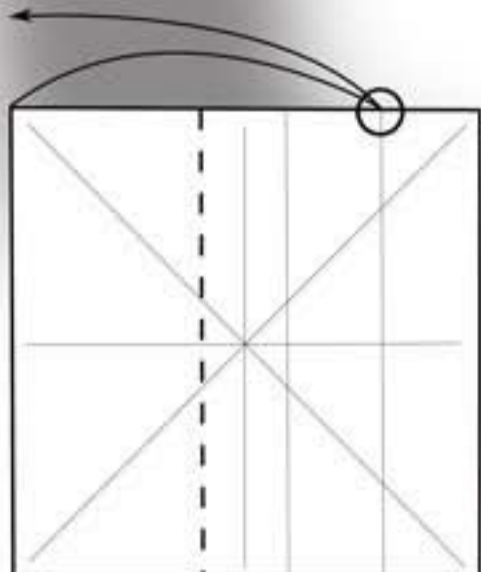

**8**

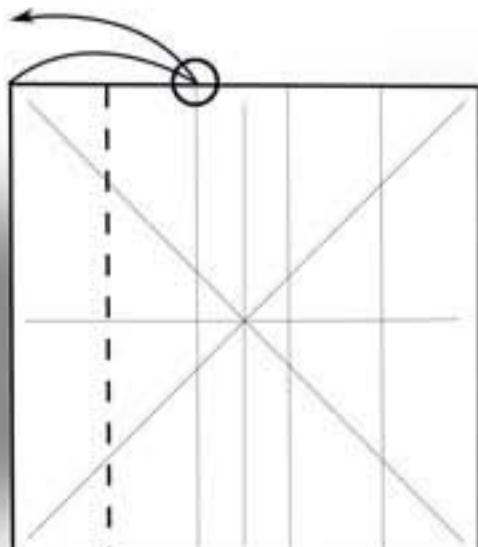

**9**

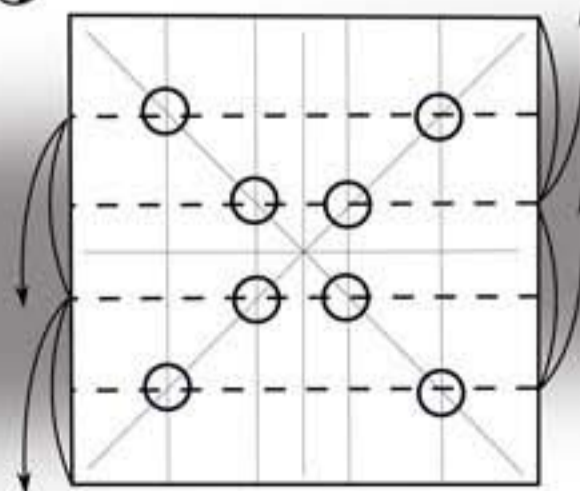



**17**

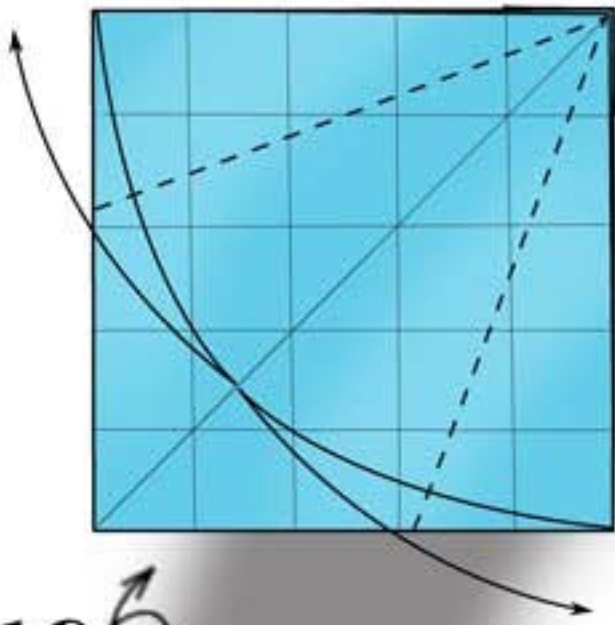

**19**



**18**

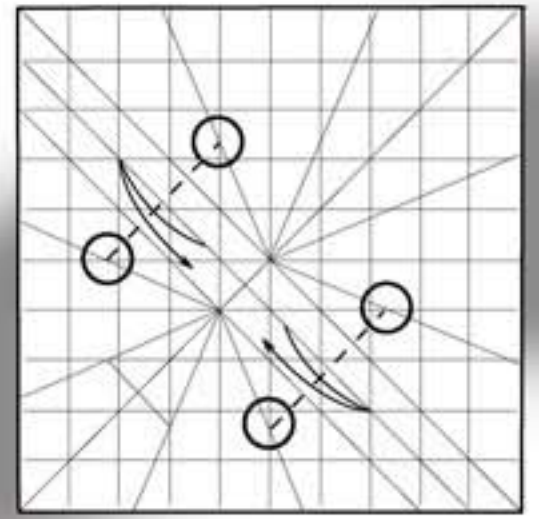
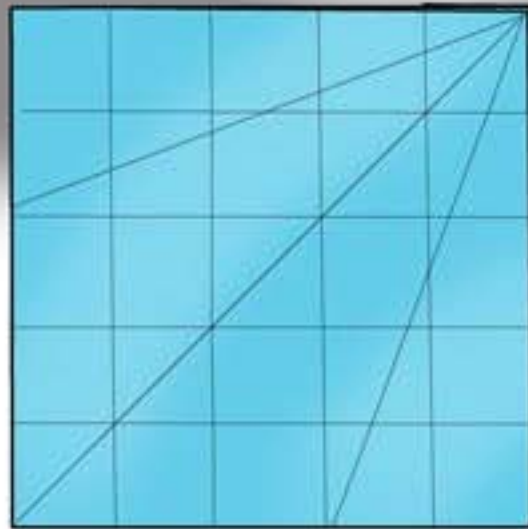

**assemble the model using the existing crease lines**

**16** ↺

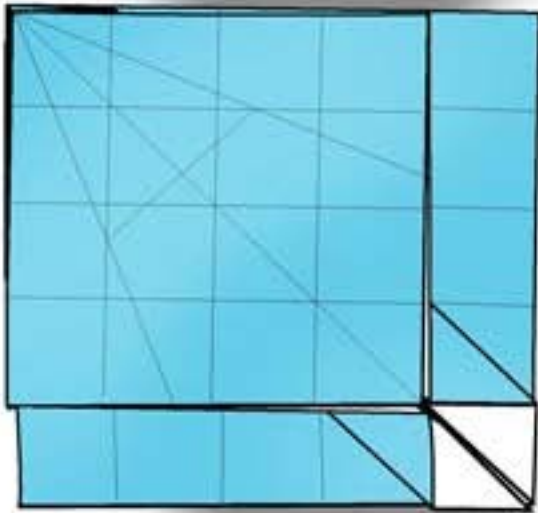

**13**

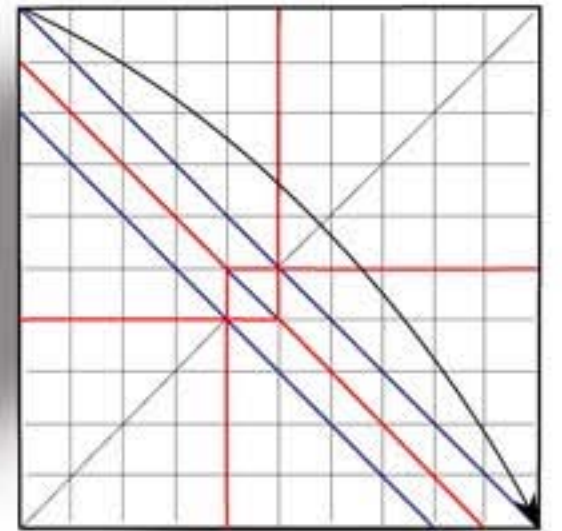

**15**

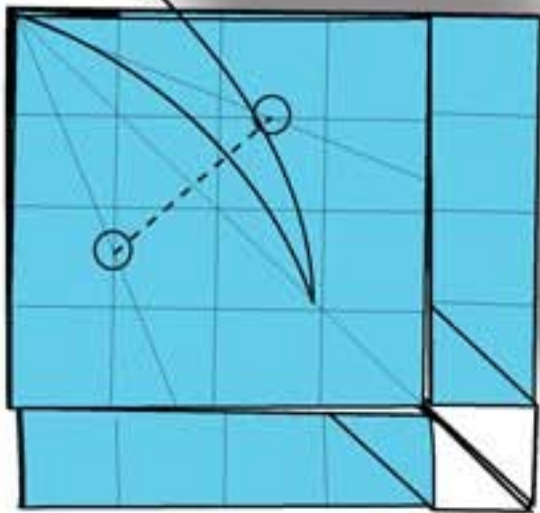

**14**

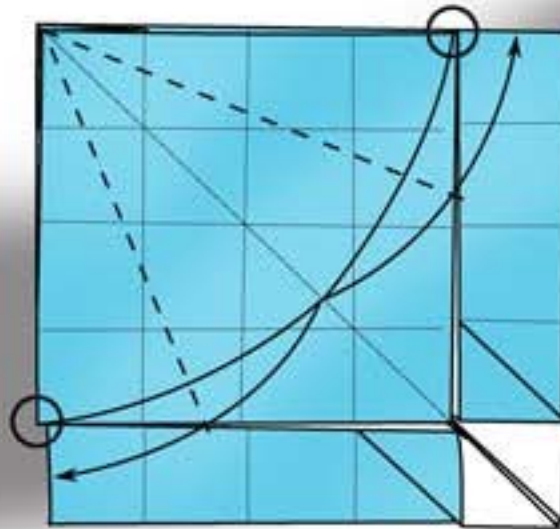

**12**

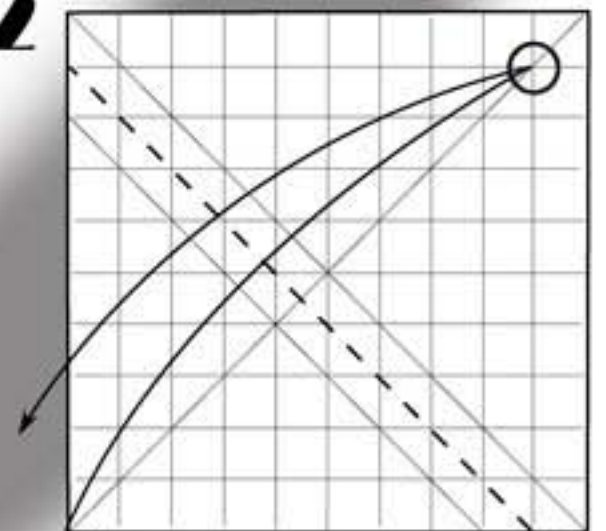

**10**

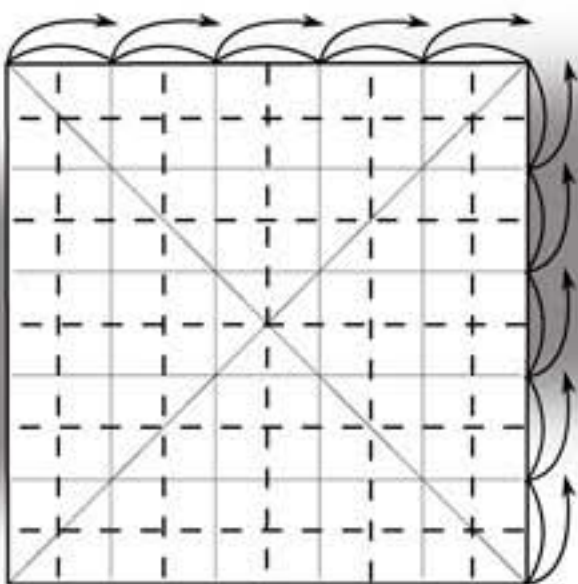

**11**

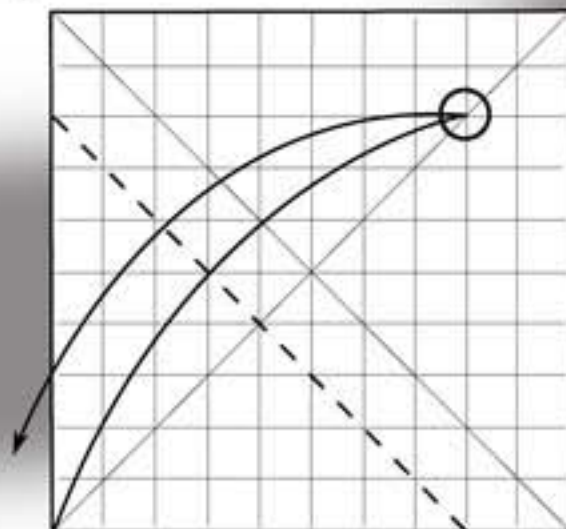



**20**

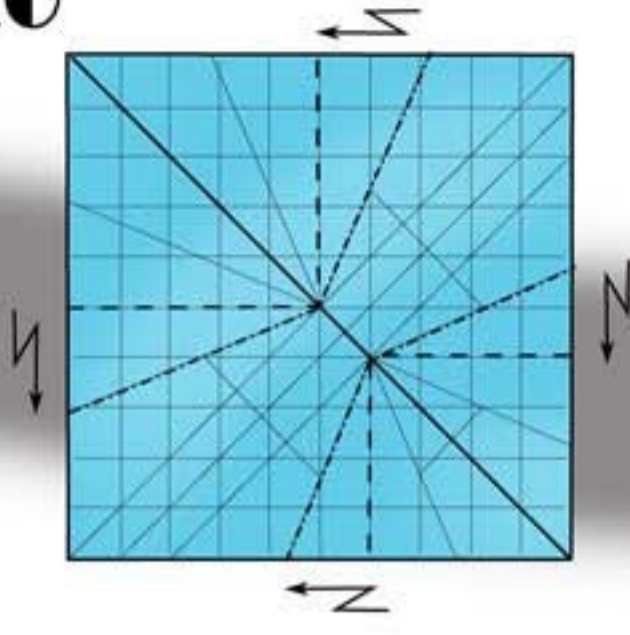

**21**

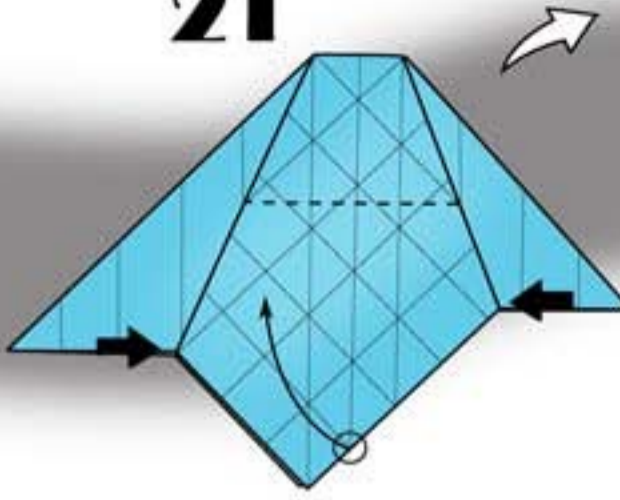

**22**

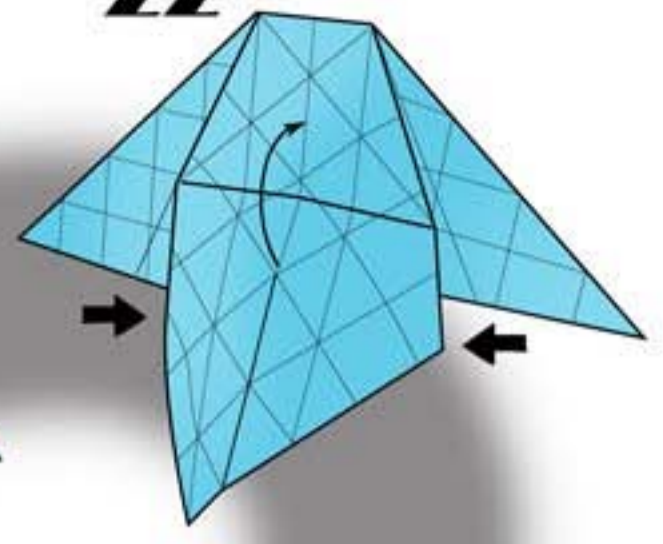

**23**

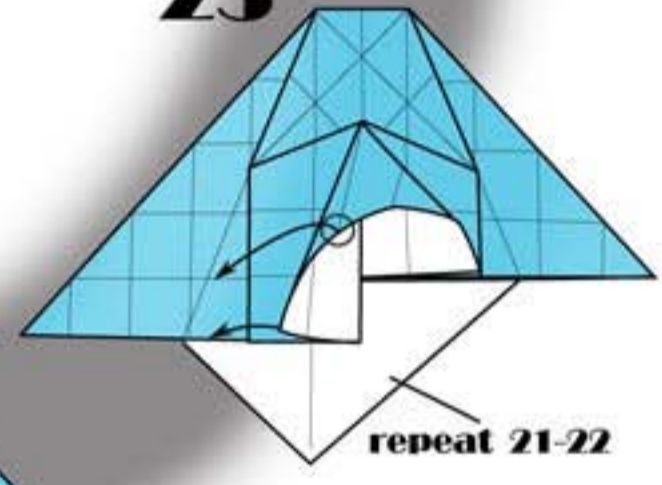

**24**

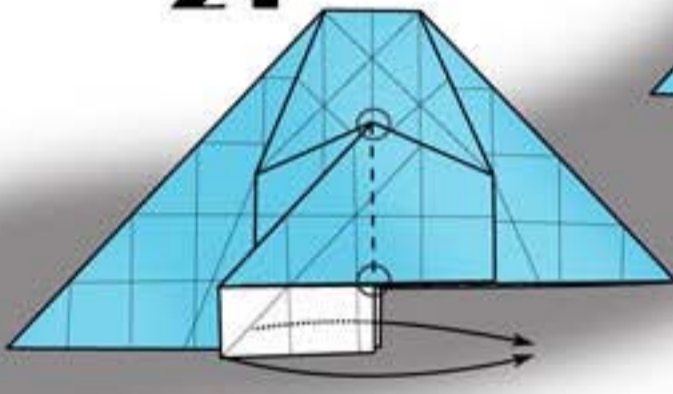

**25**

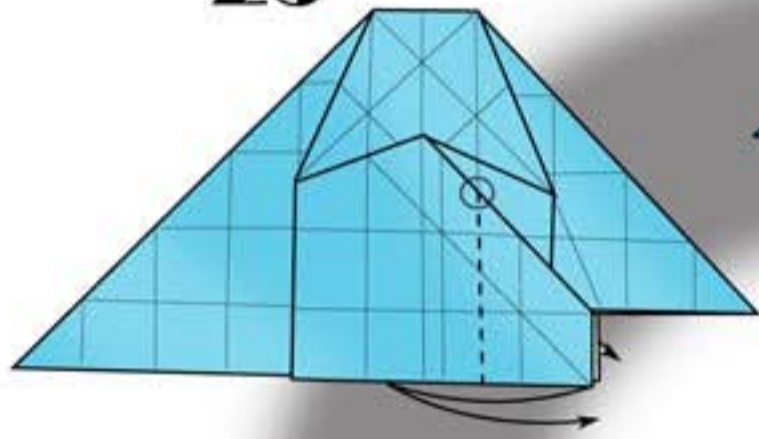

**31**

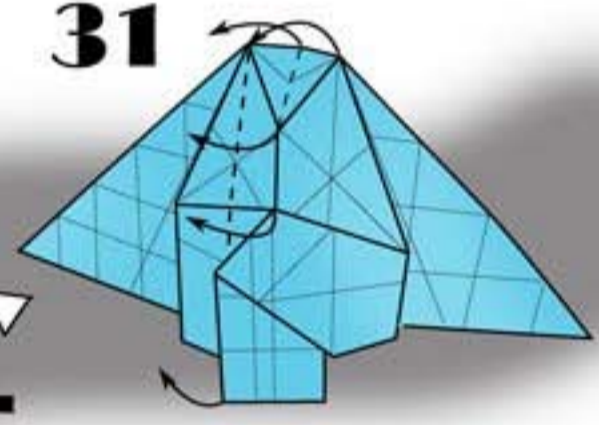

**26**

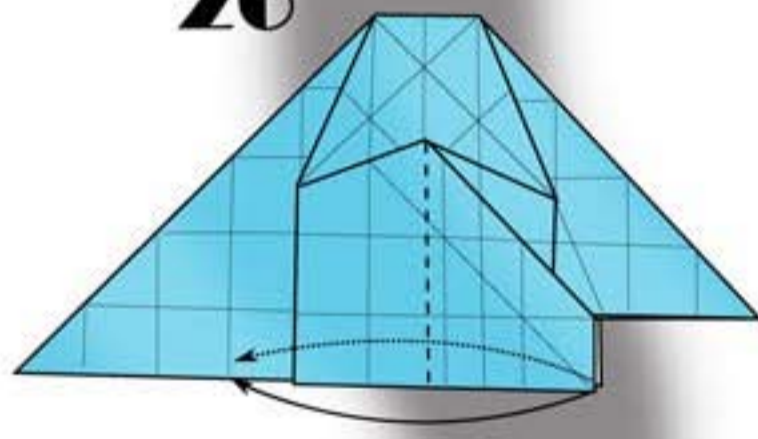

**30**

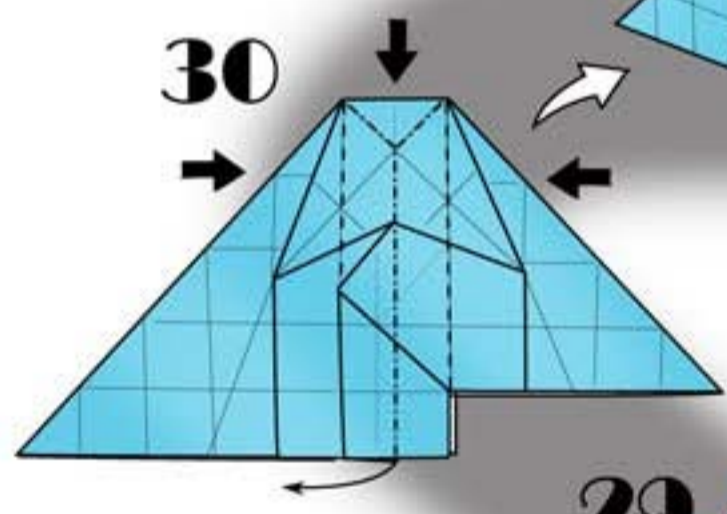

**29**

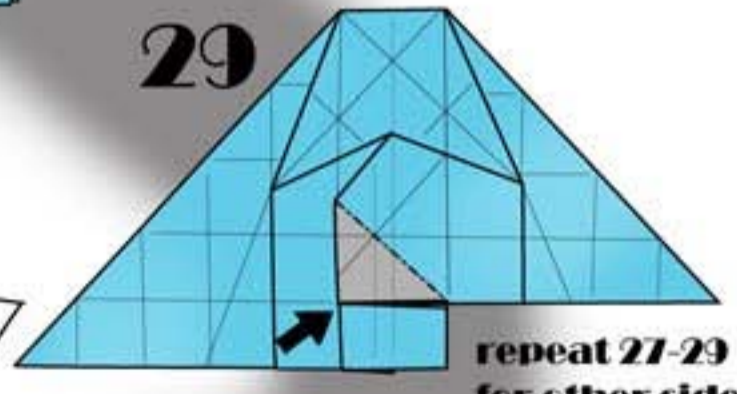

**27**

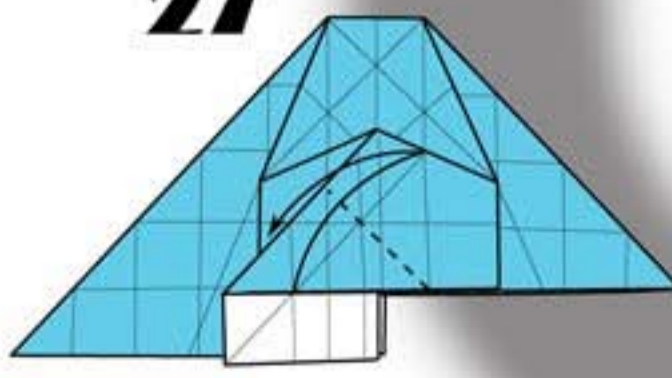

**28**

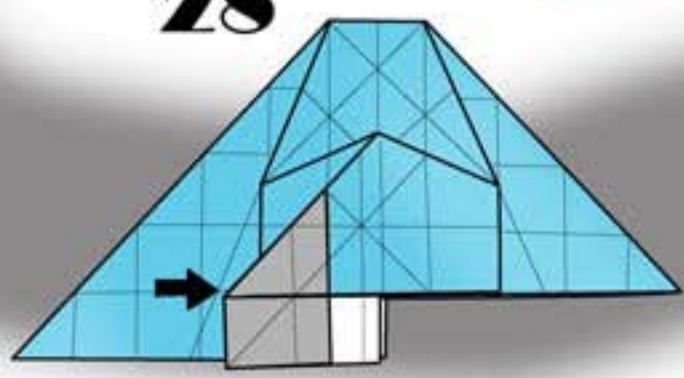

repeat 27-29 for other side



**39**

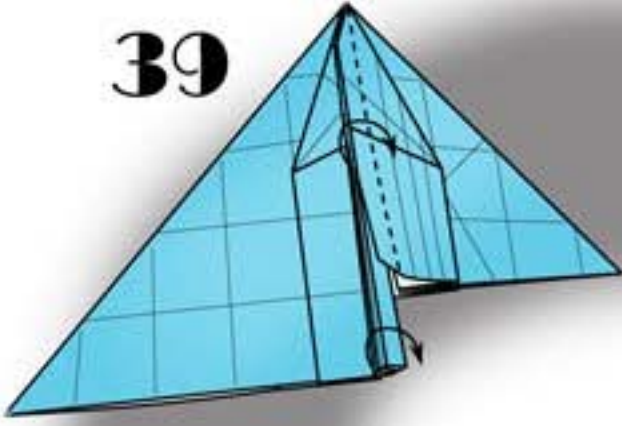

**40**

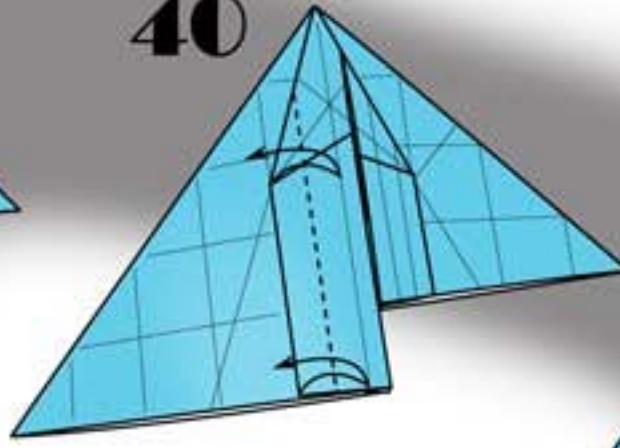

**41**

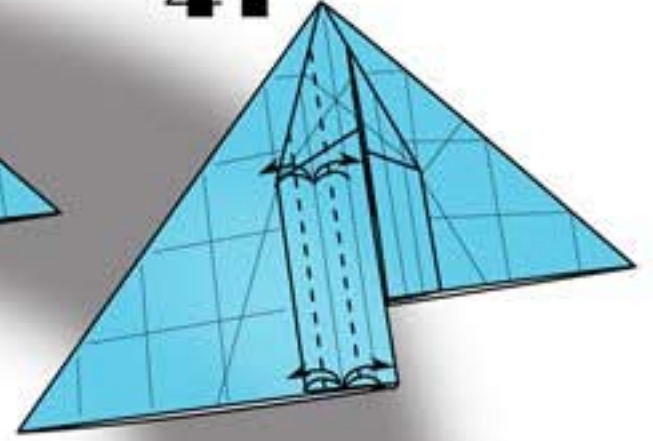

**38**

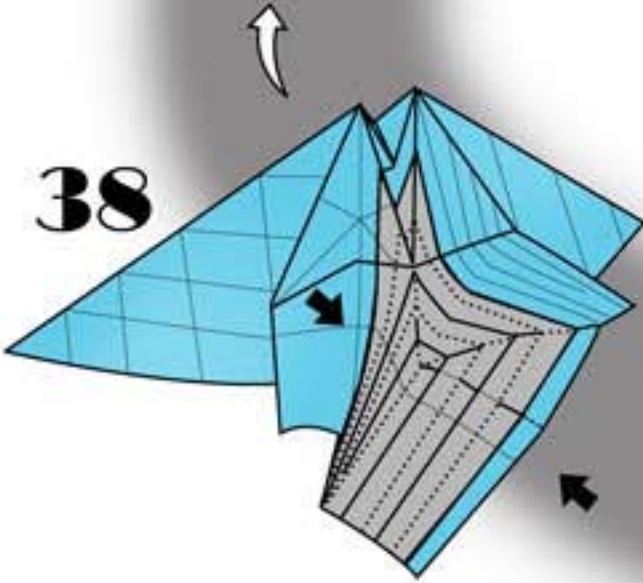

**37**

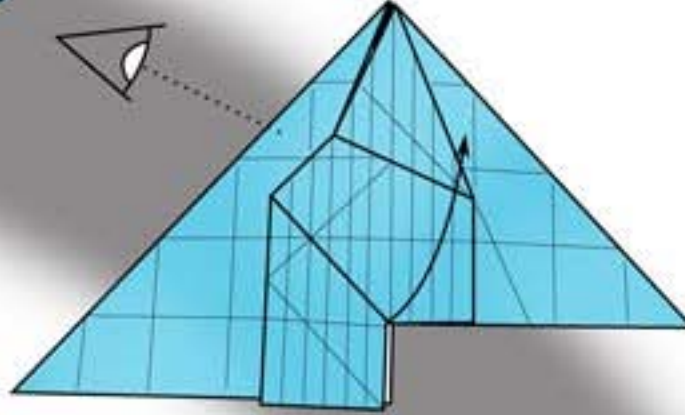

**42**

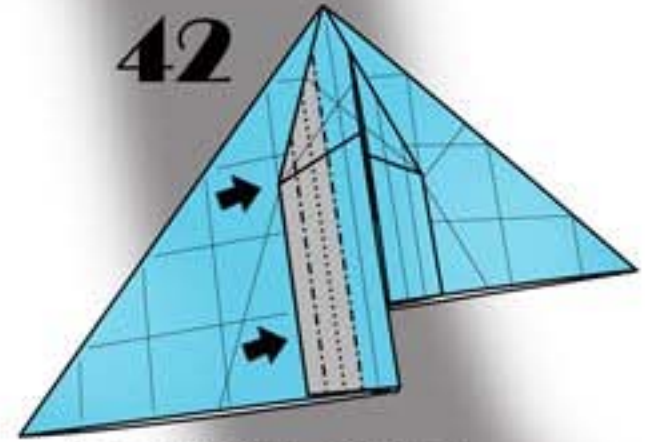

**repeat 35-42 for other side**

**32**

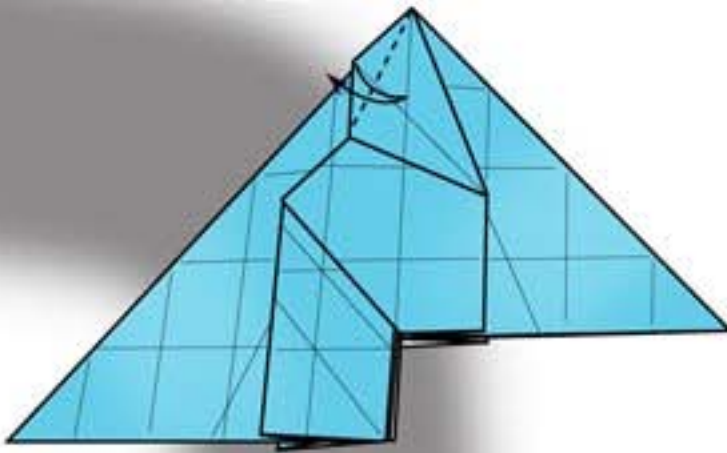

**36**

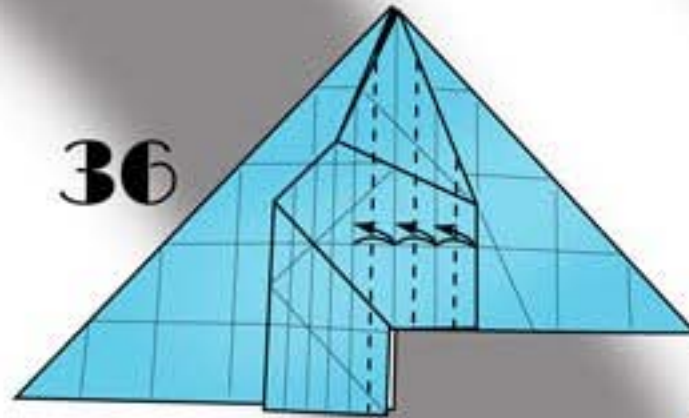

**35**

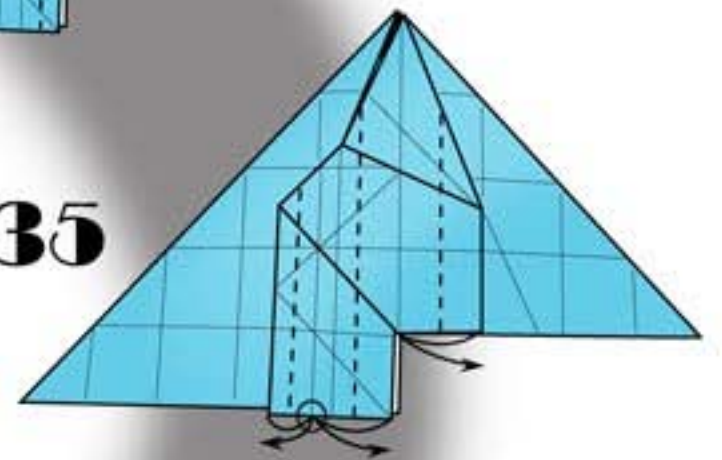

**33**

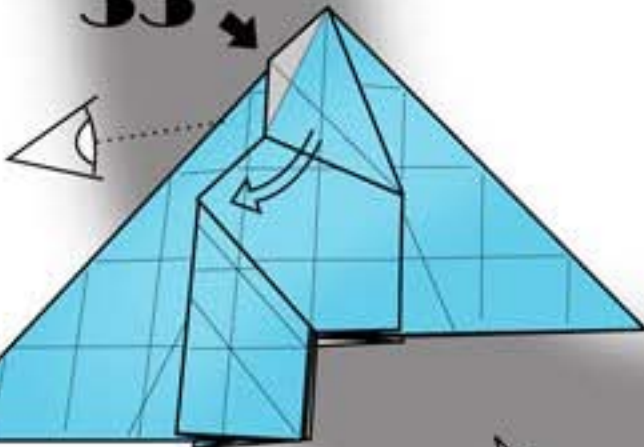

**34**

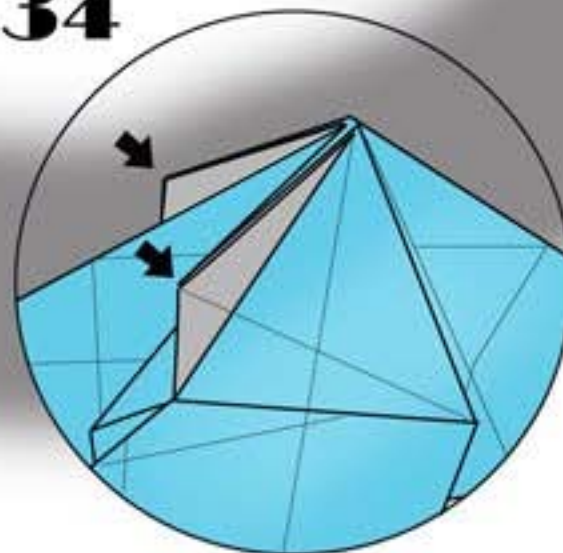



50

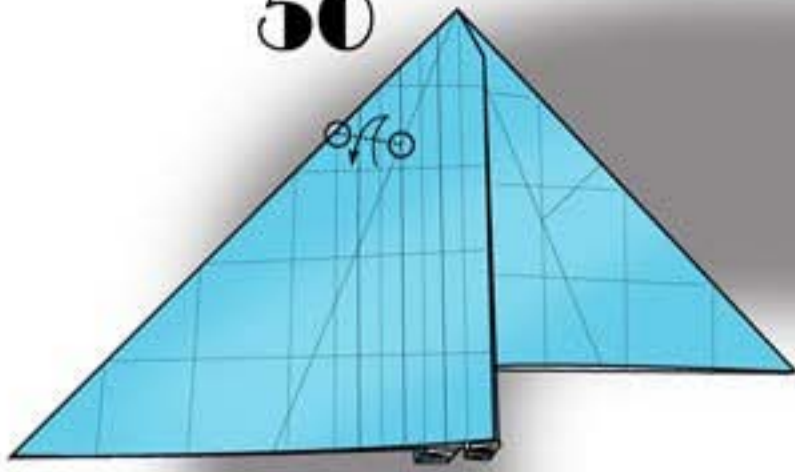

51

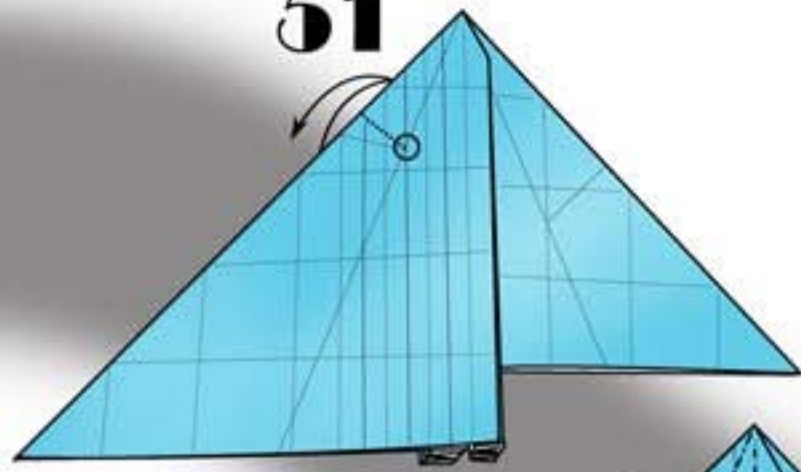

49

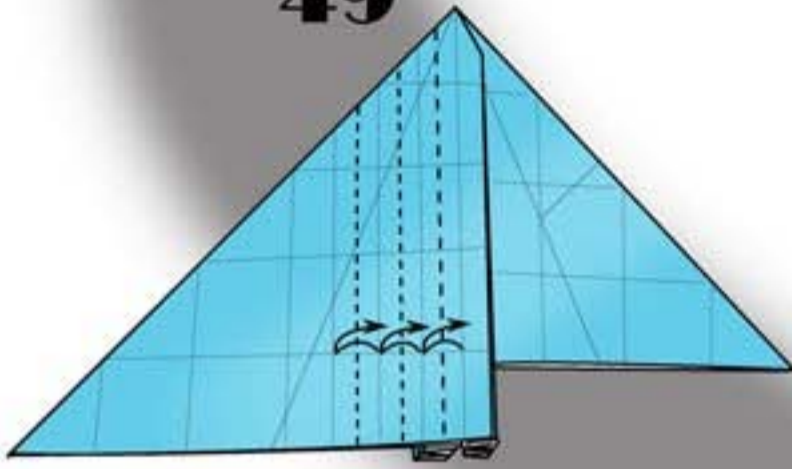

52

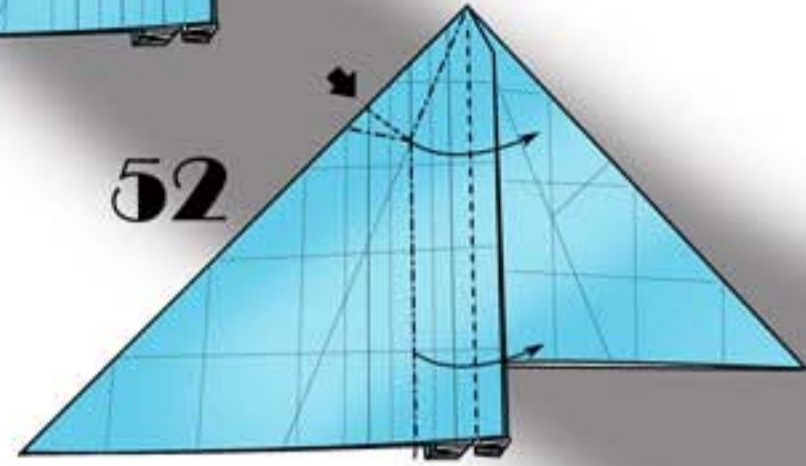

48

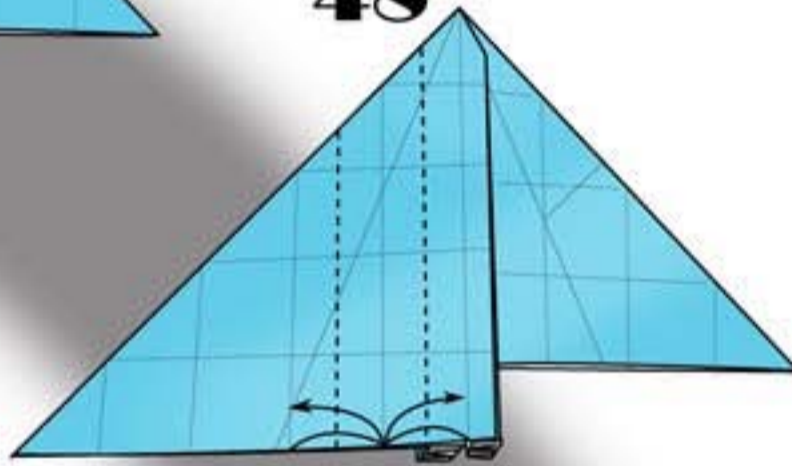

43

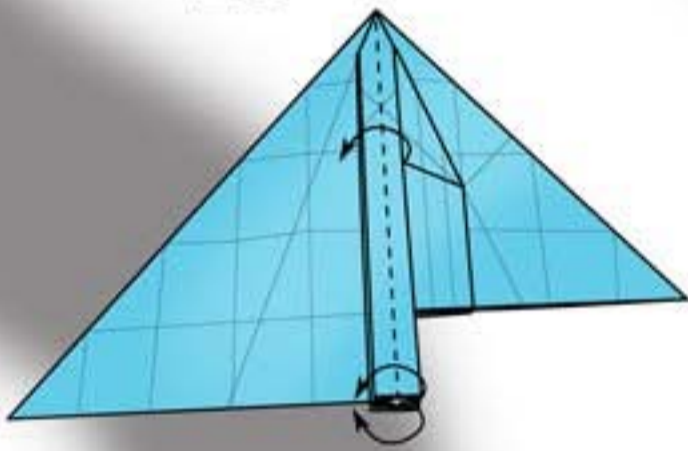

47

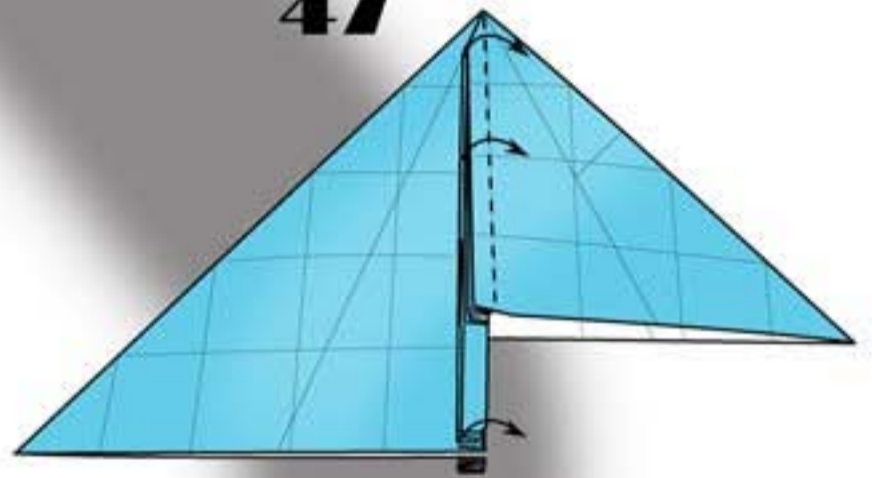

44

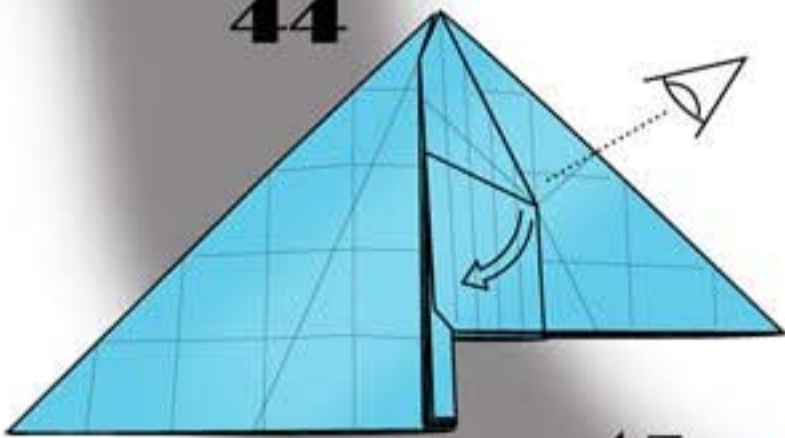

46

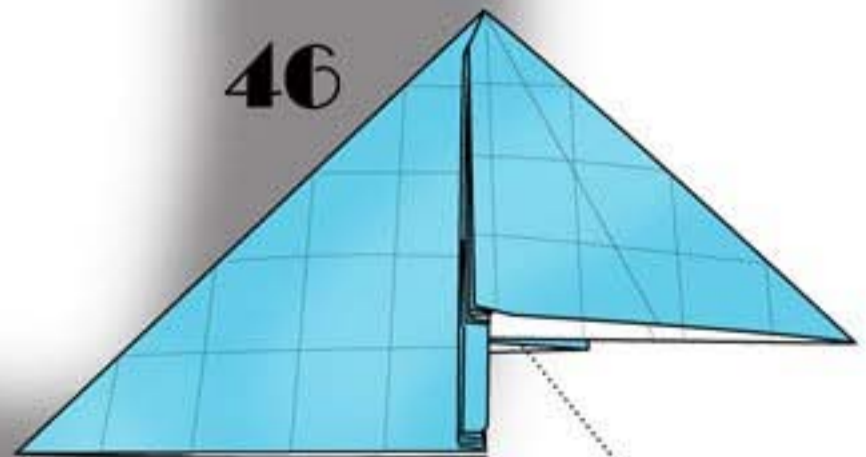

45

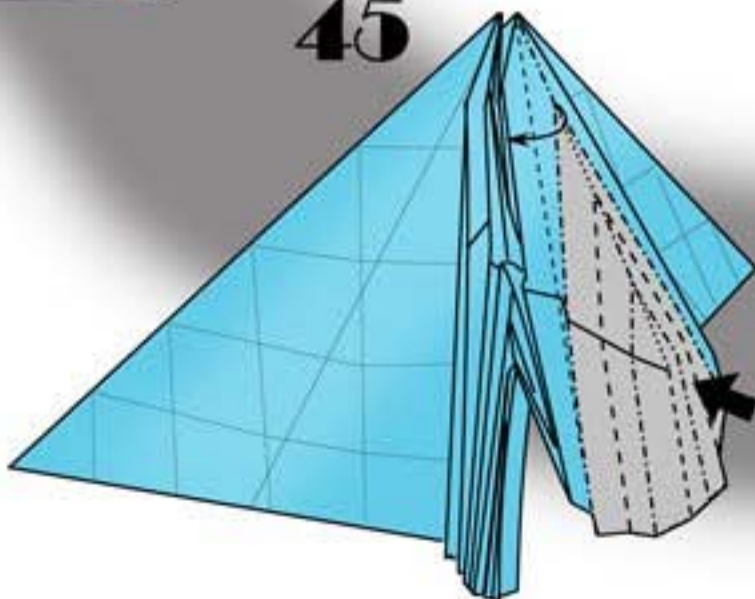

repeat 44-45



59

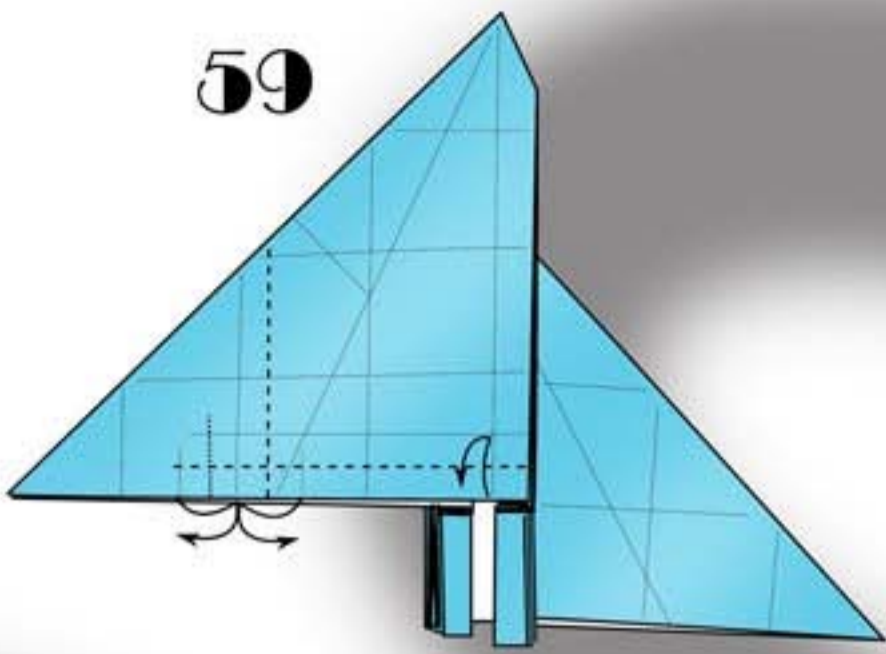

60

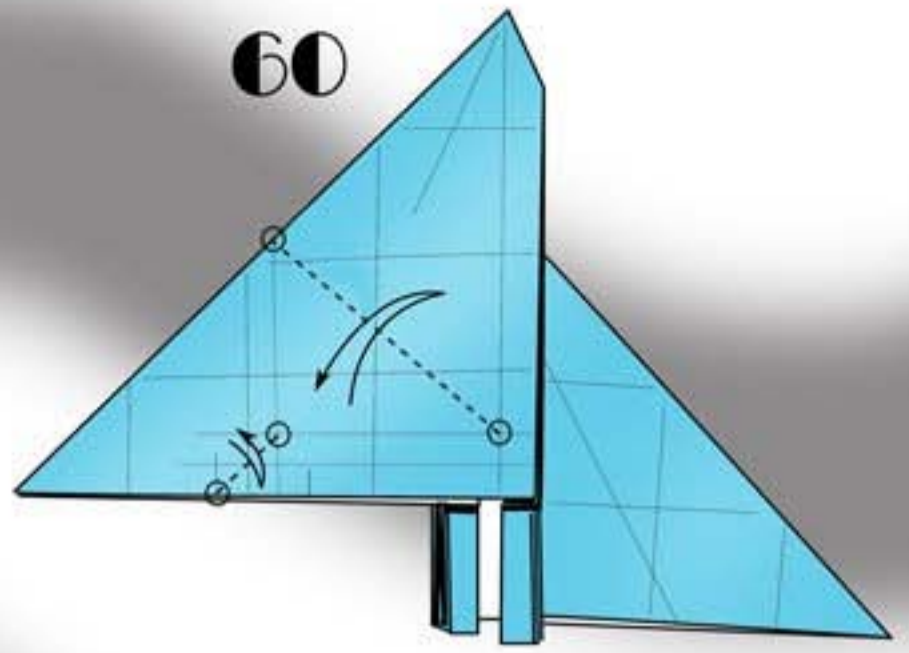

53

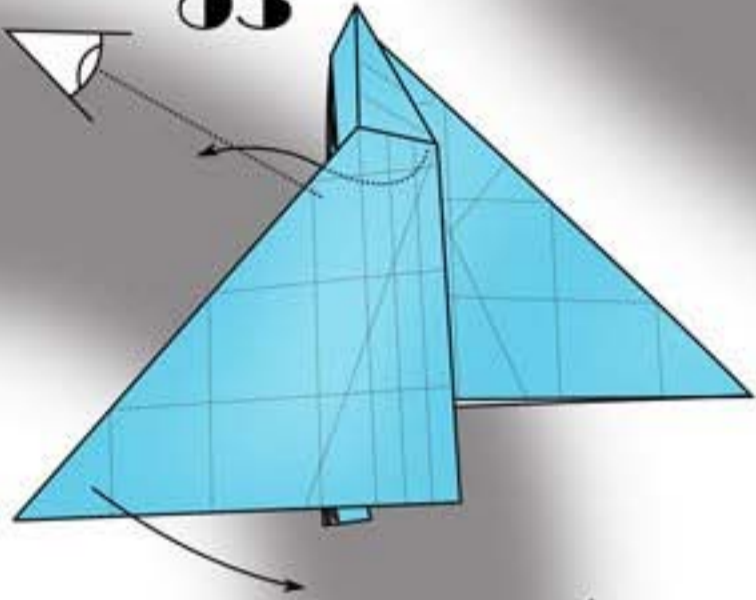

58

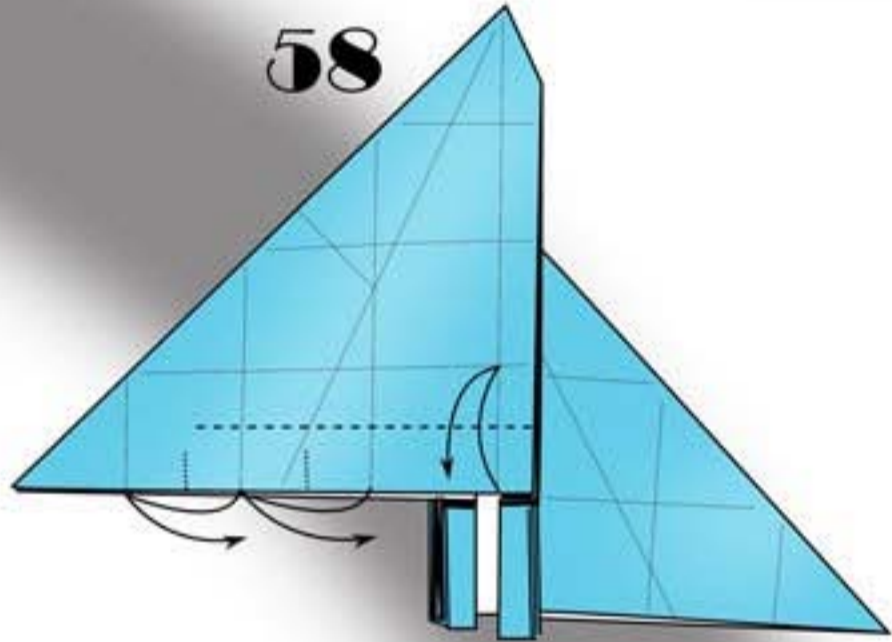

54

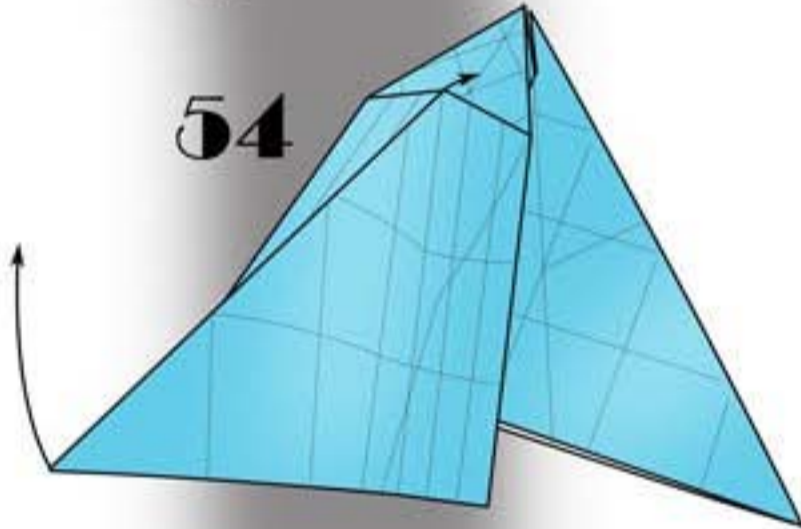

57

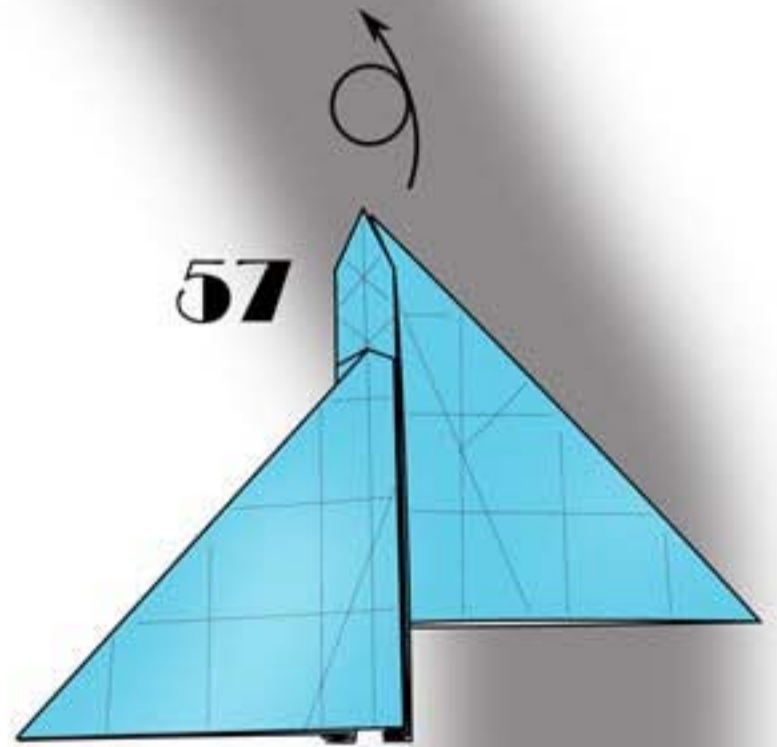

55

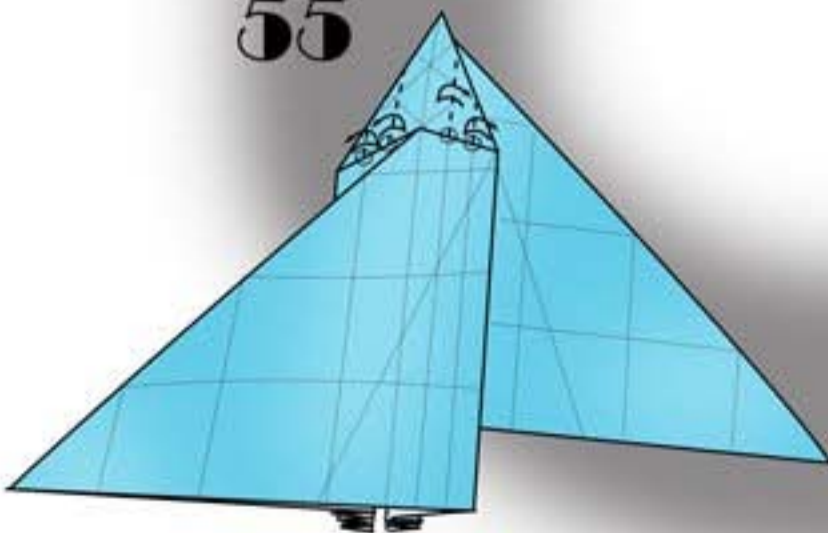

56

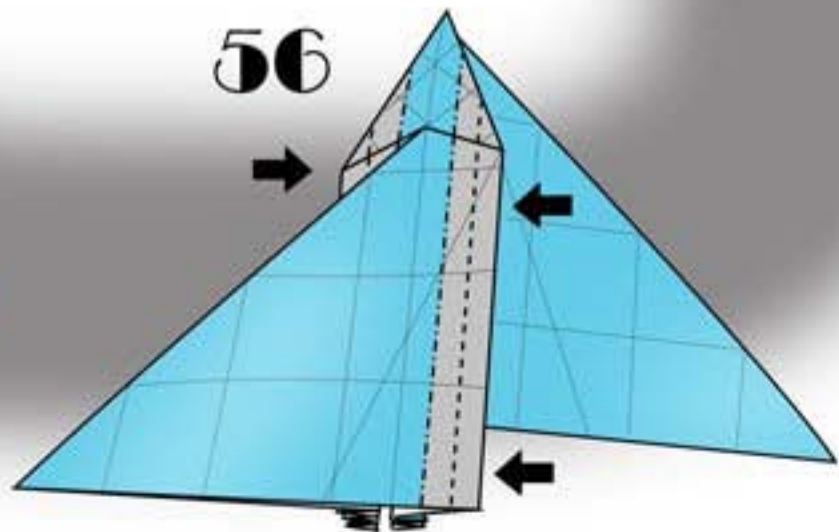



62

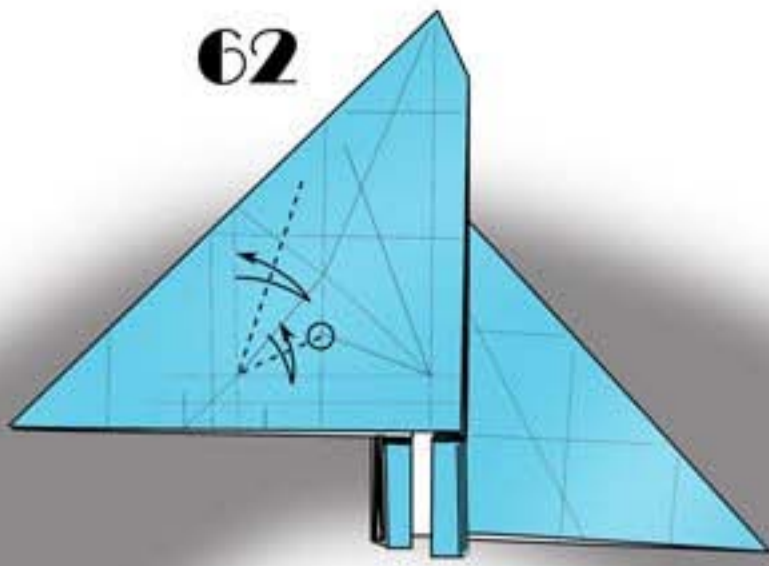

61

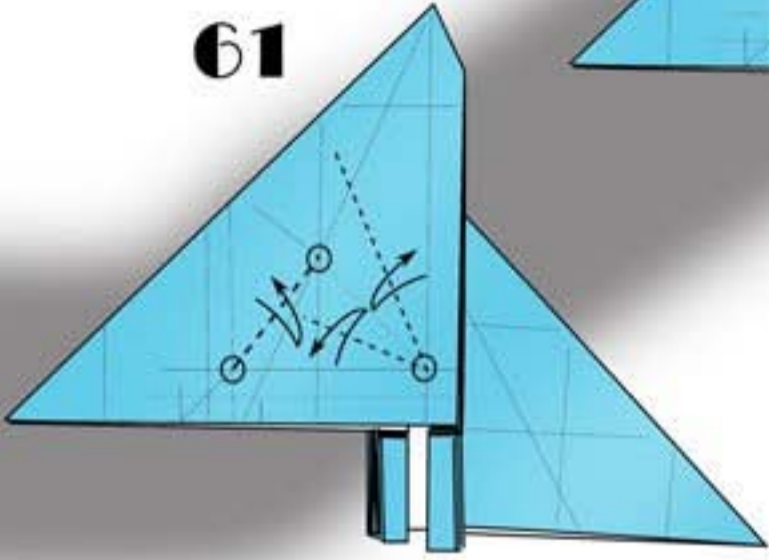

63

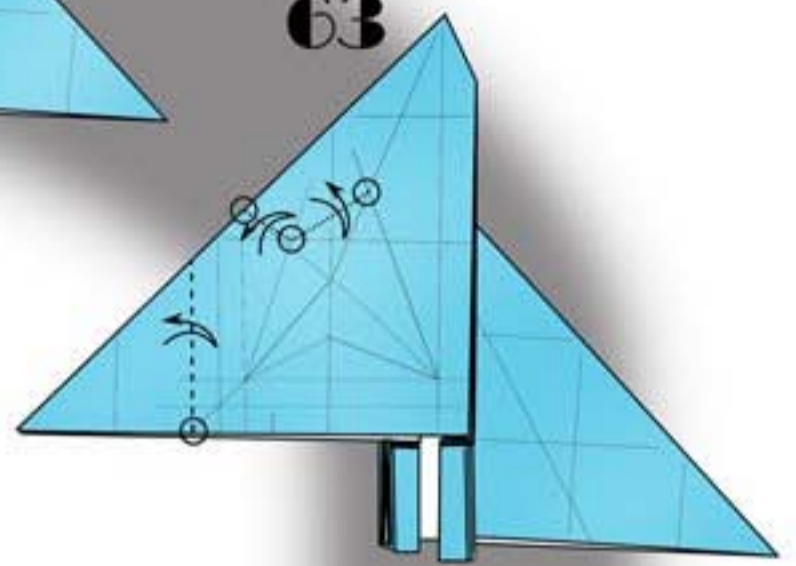

65

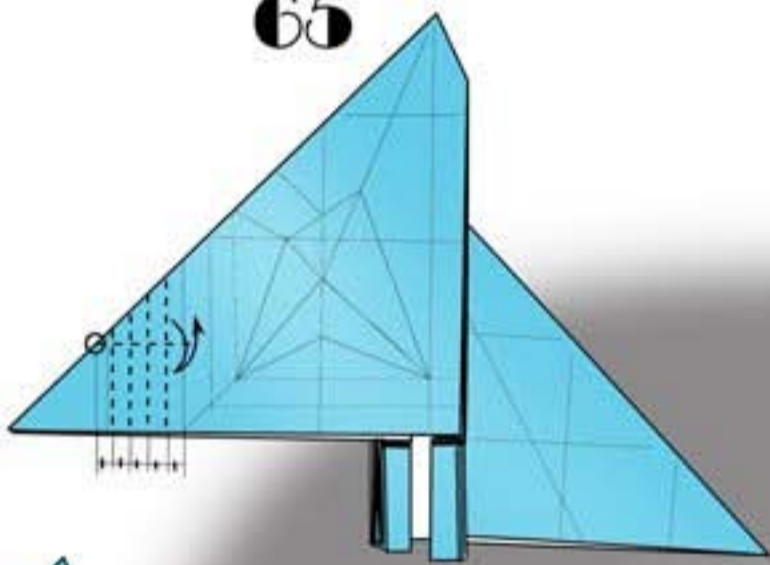

64

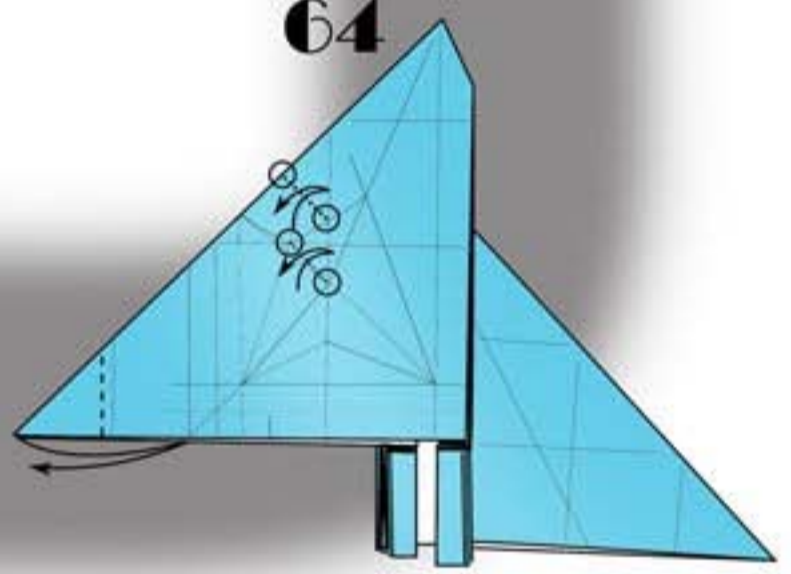

66

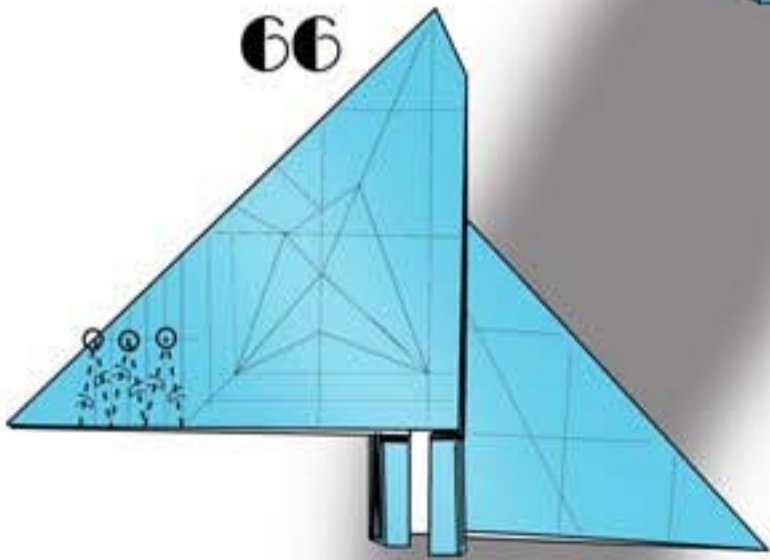

70

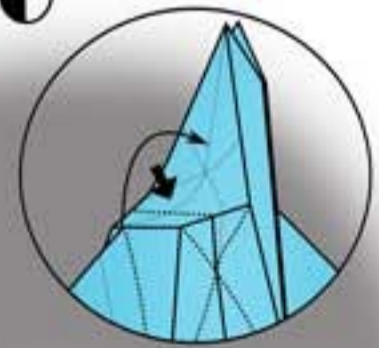

69

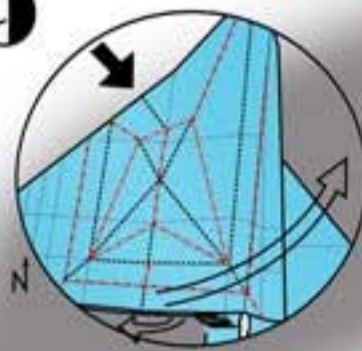

71

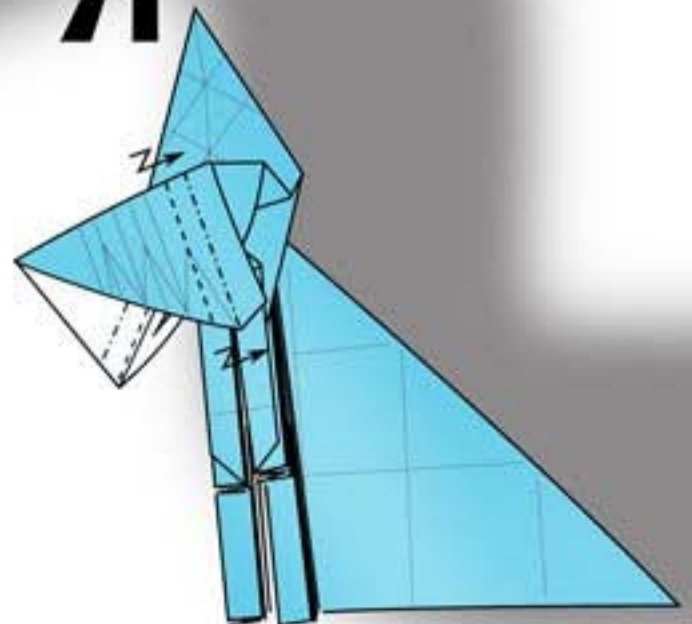

67

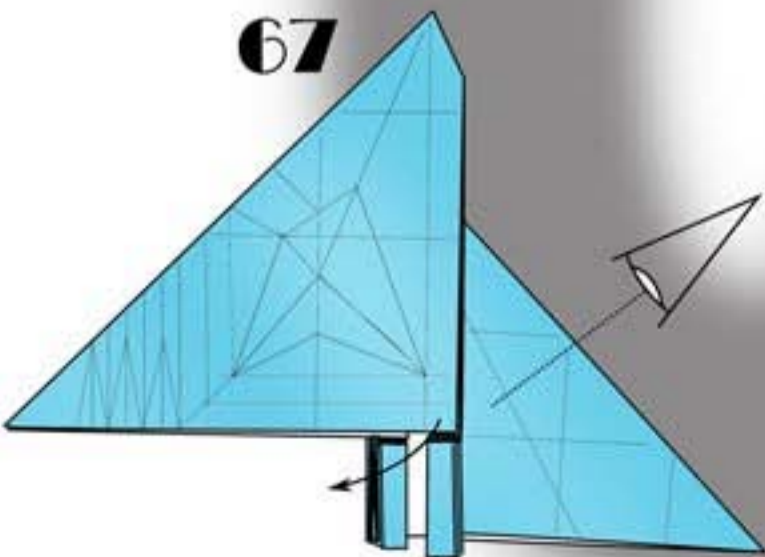

68

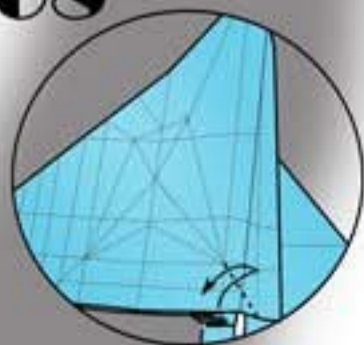



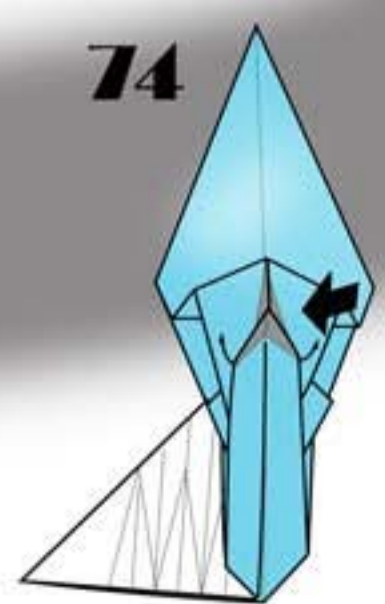
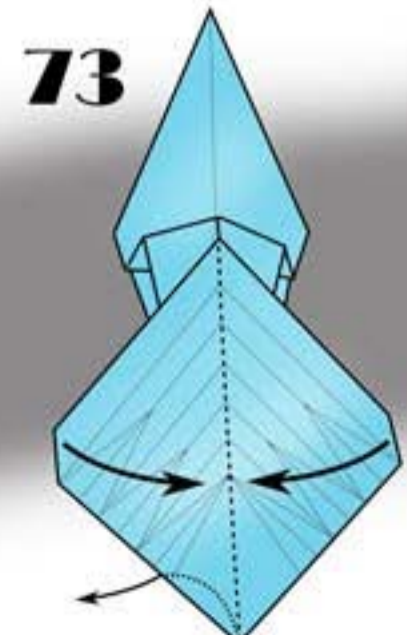
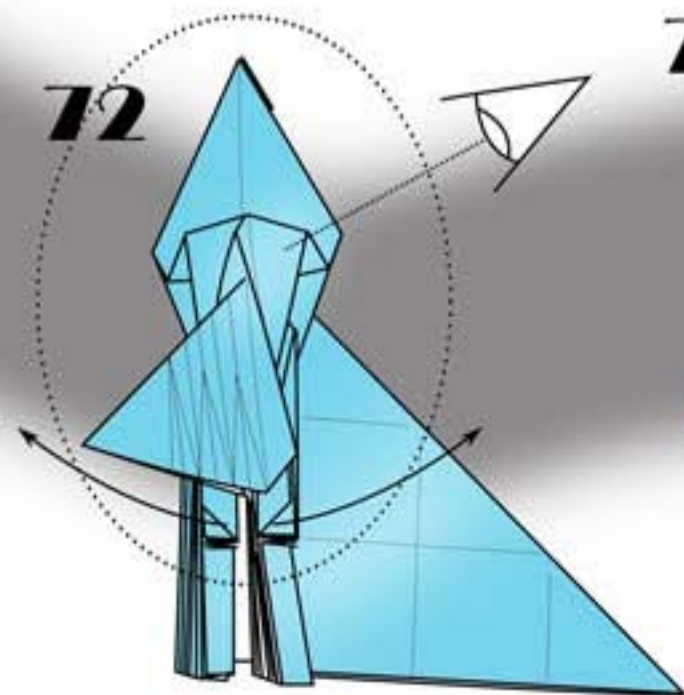
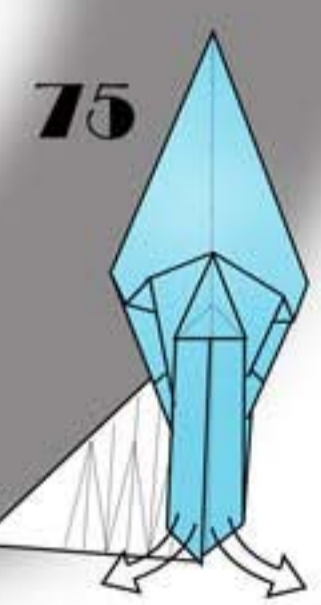
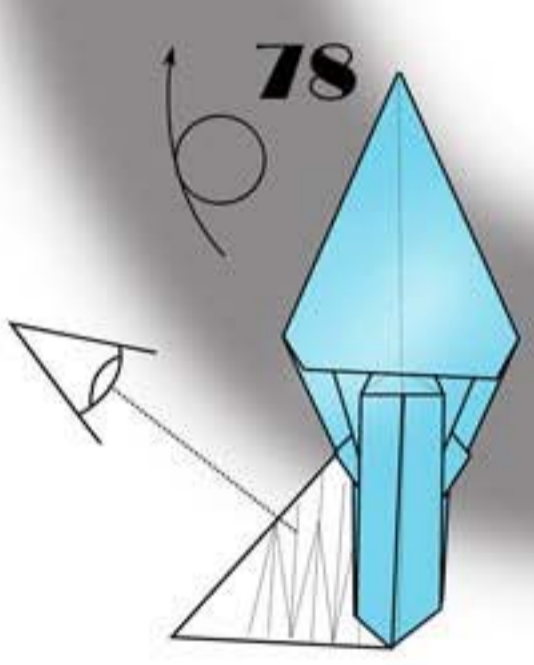
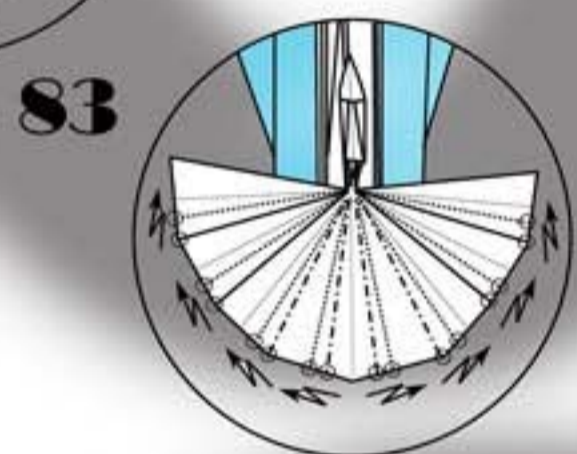
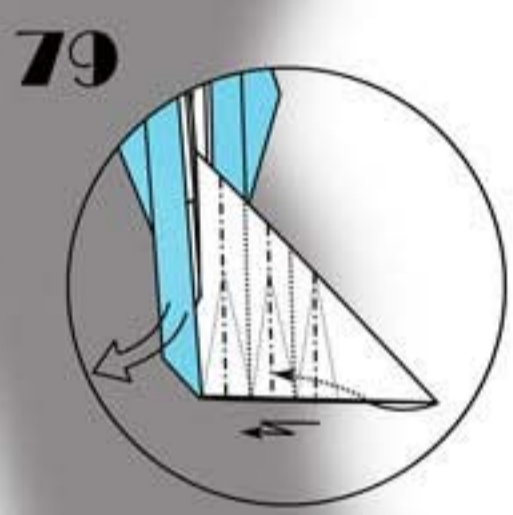
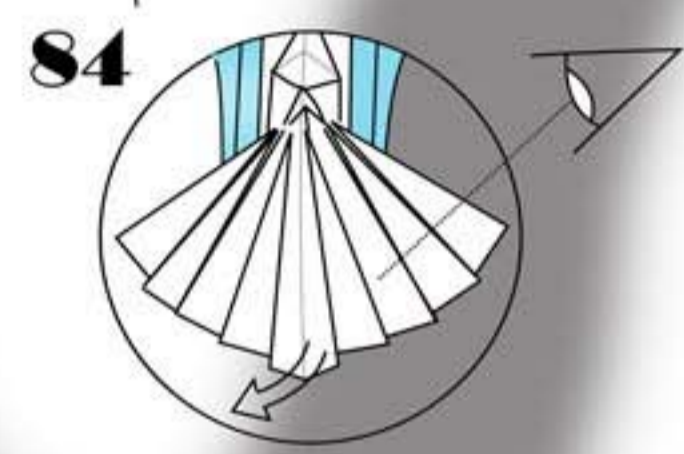
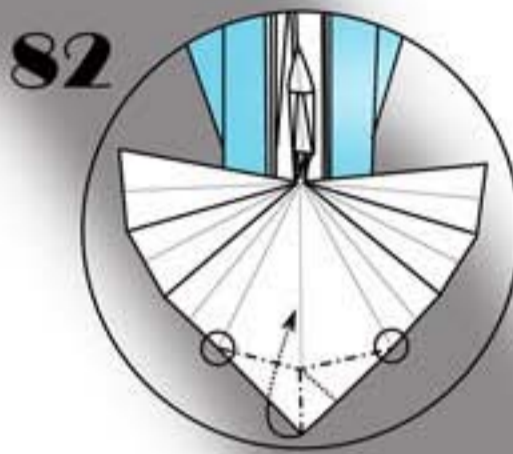
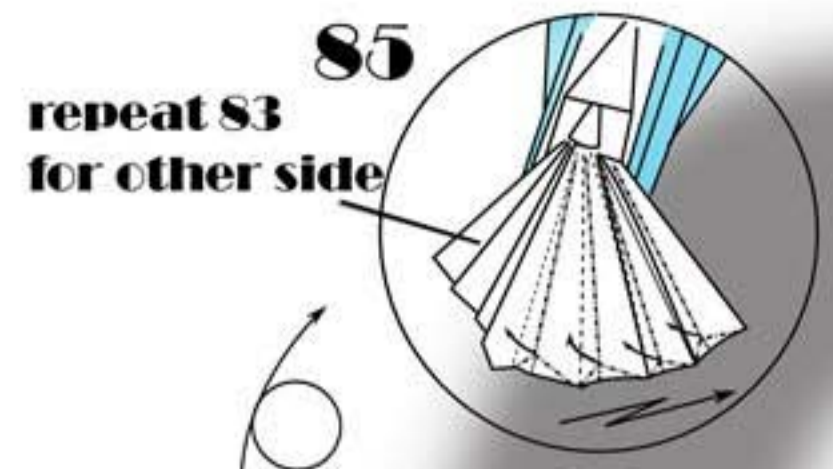
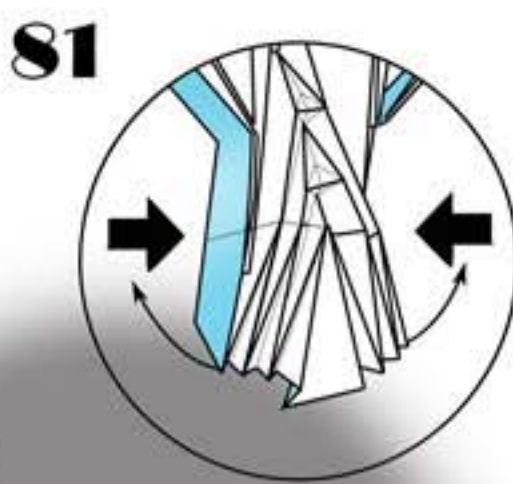



**86**



**87**



**88**



**90**

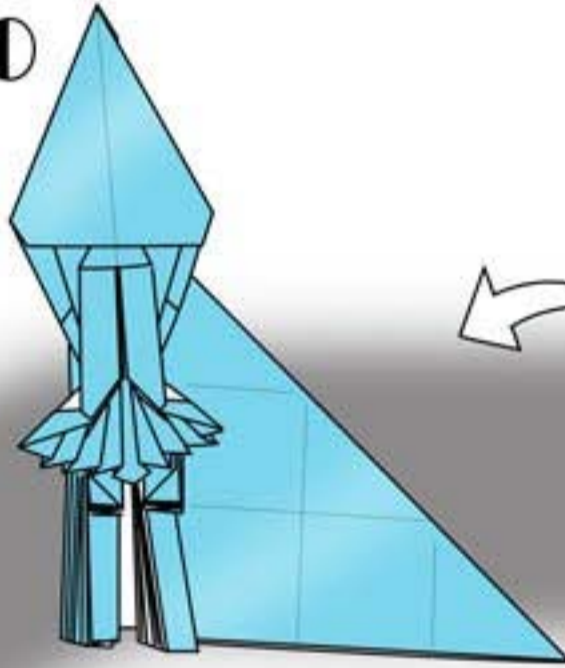

**89**

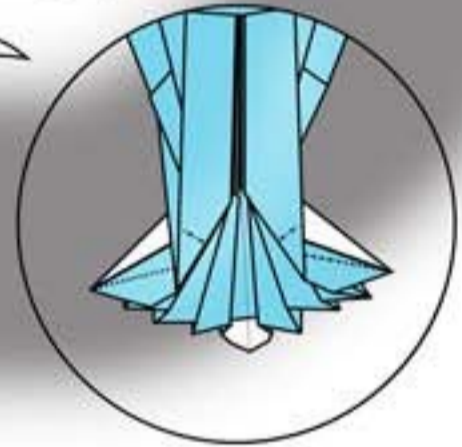

**91**

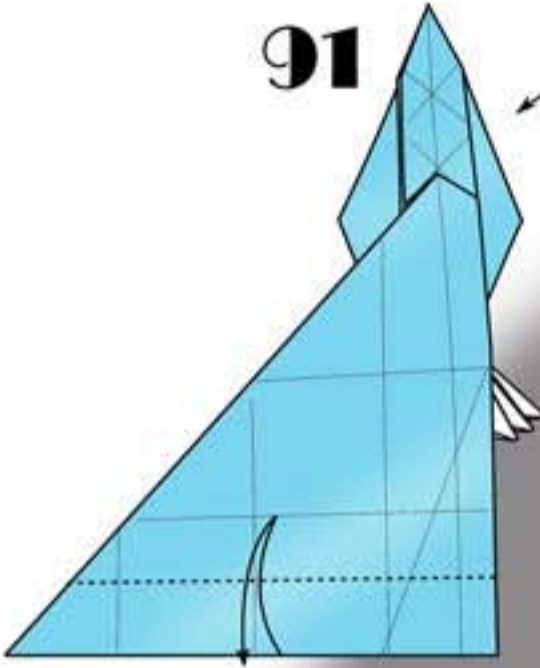

**92**

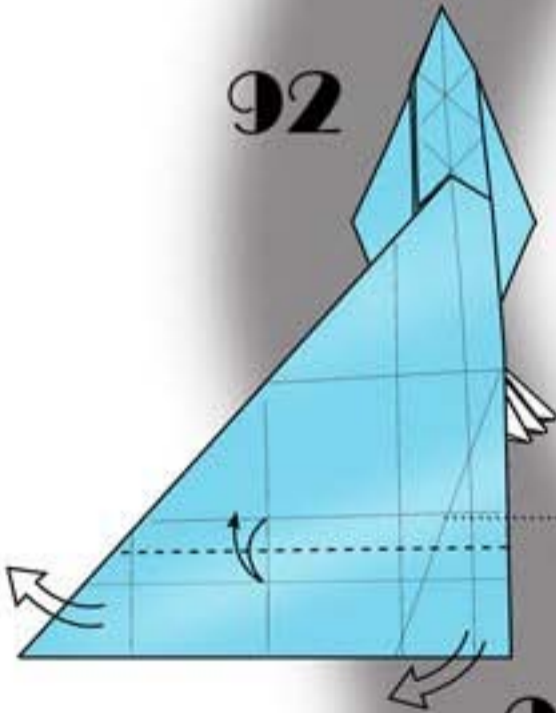

**95**

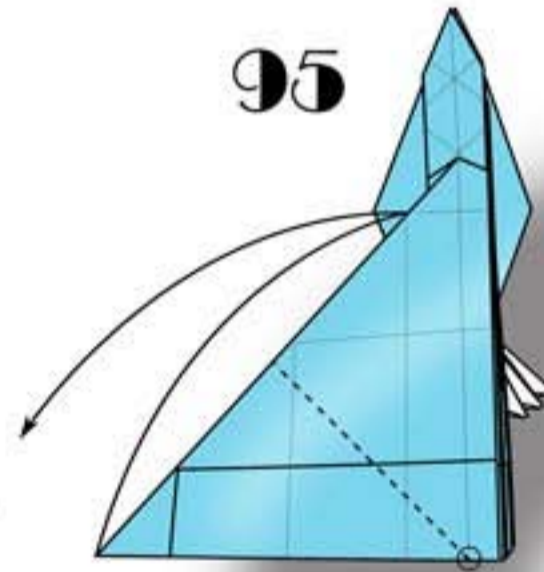

**96**

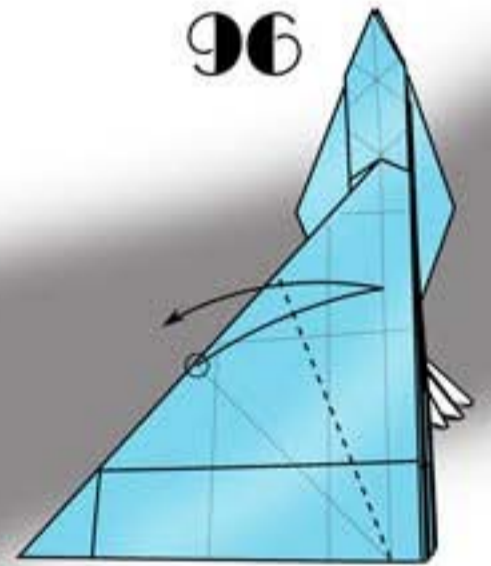

**93**

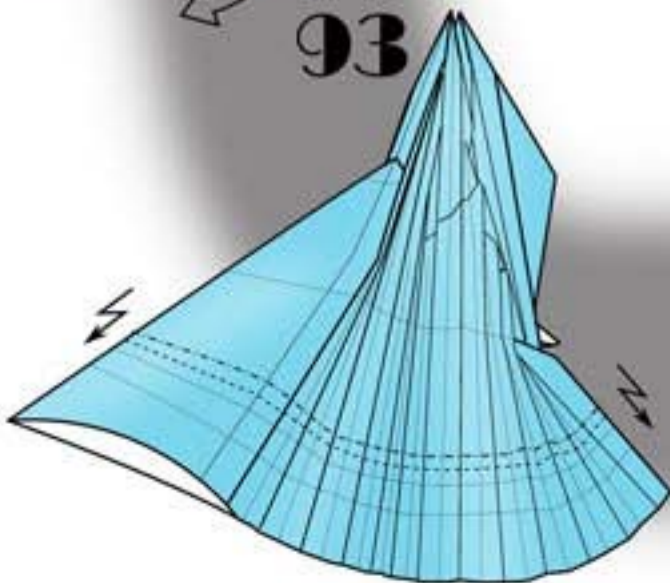

**94**

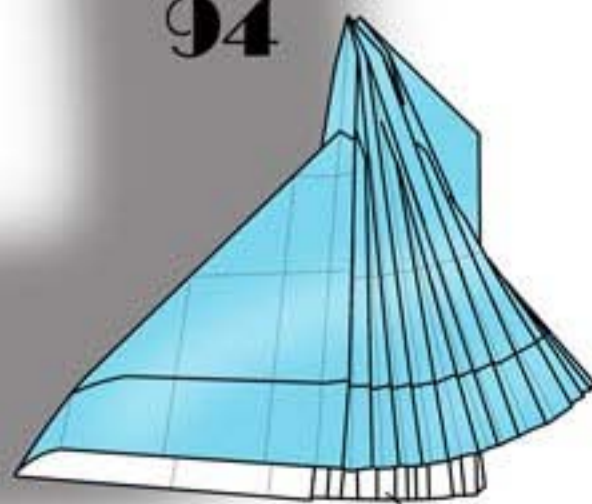

**repeat 93 for other side**



**106**

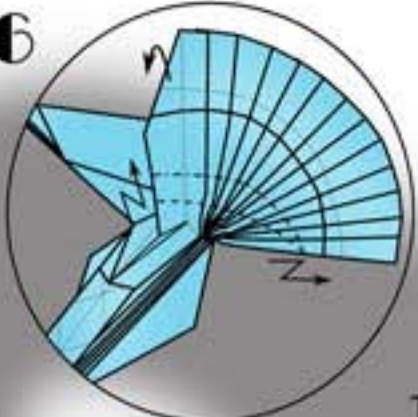

**111**

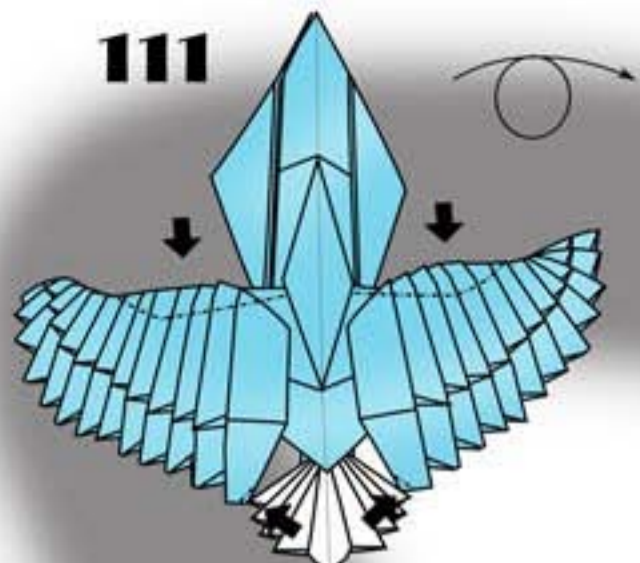

**105**

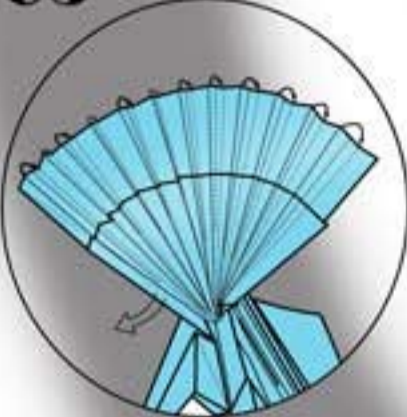

**107**

repeat 104-106 for other wing

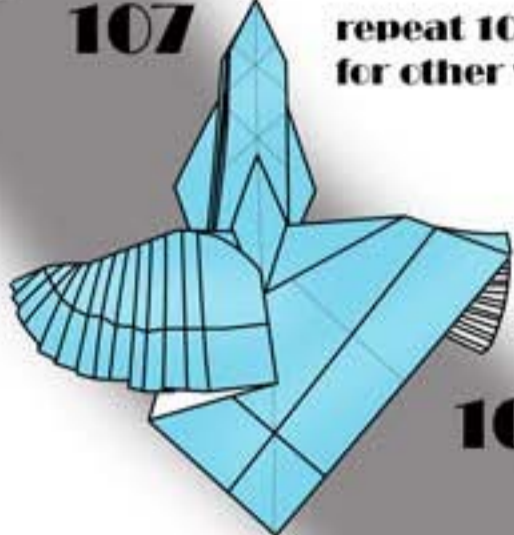

repeat 110 for other parts

**110**

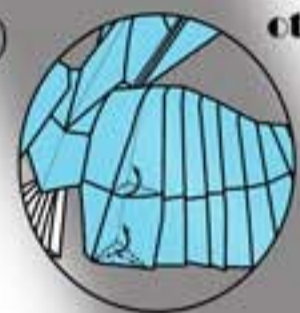

**108**

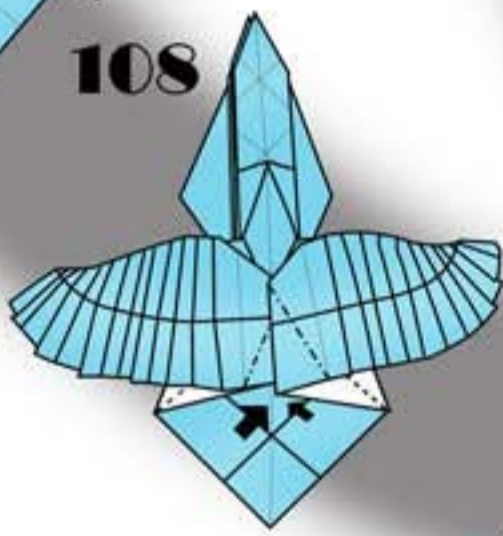

**104**

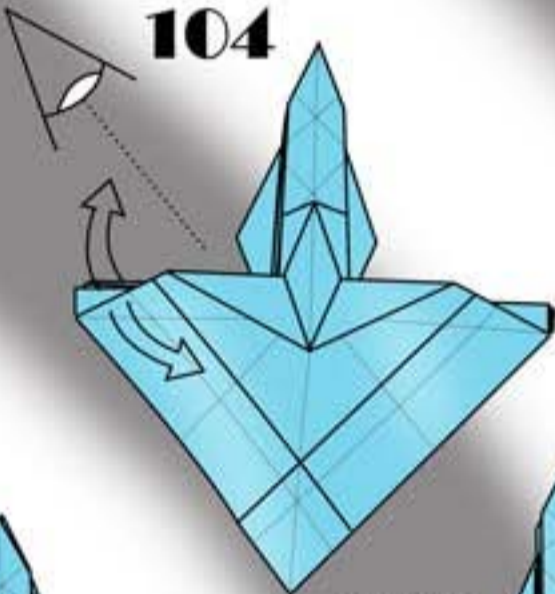

**109**

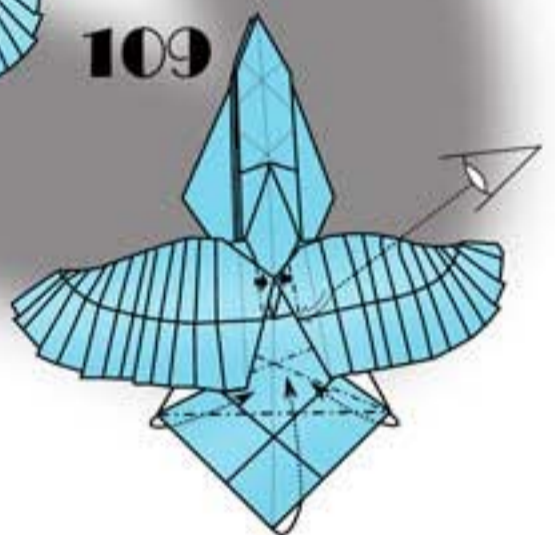

**97**

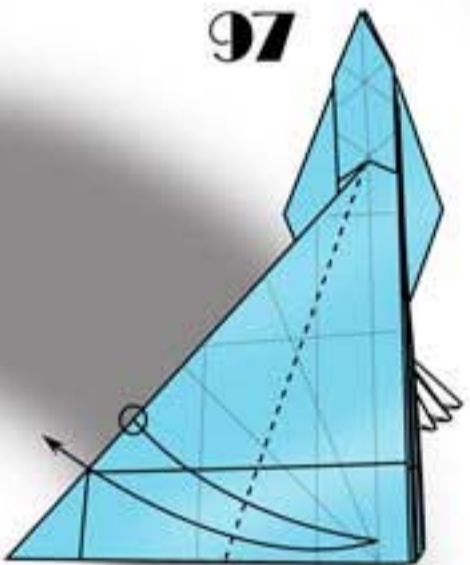

**103**

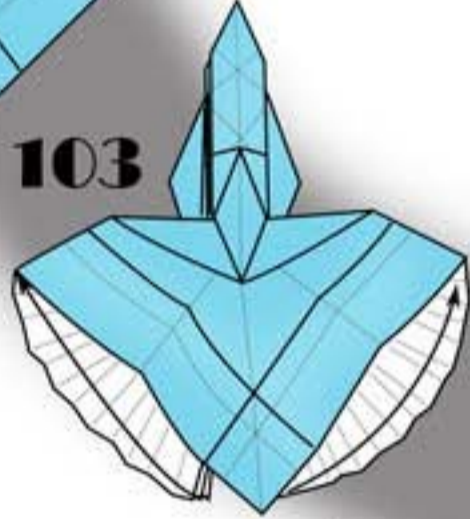

**102**

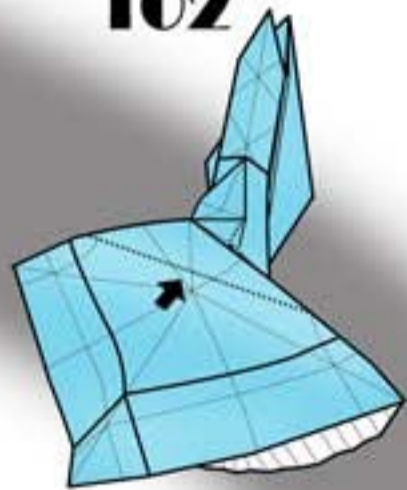

**101**

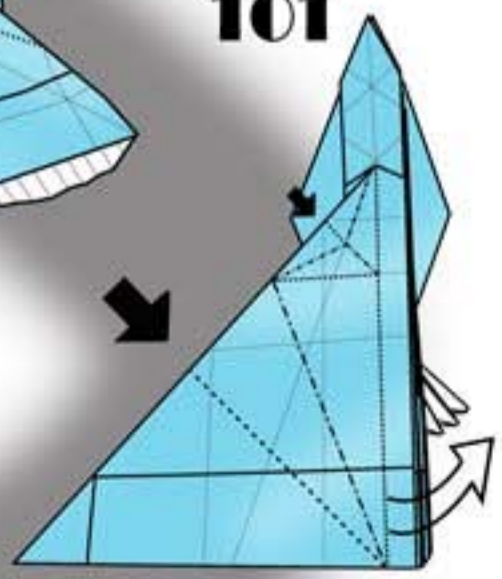

**98**

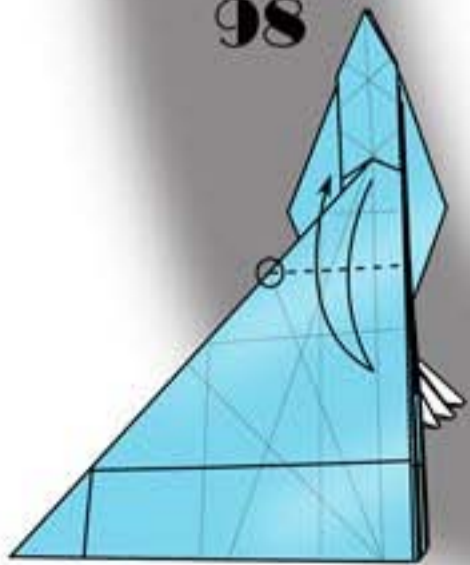

**99**

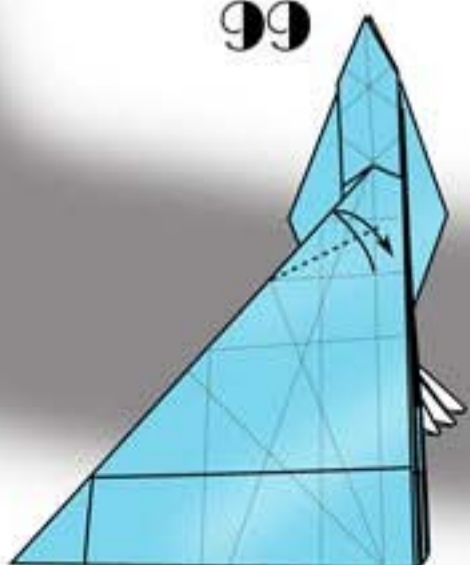

**100**

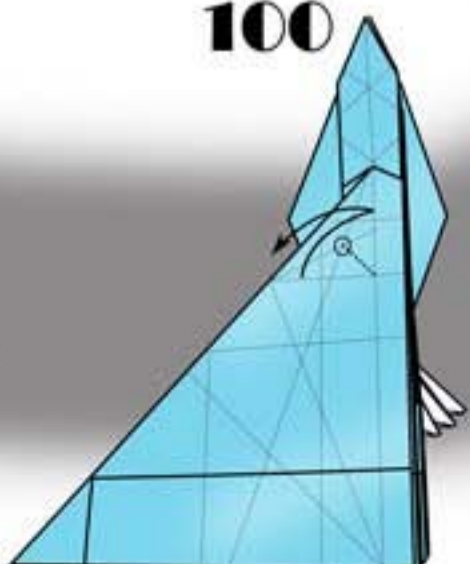



112

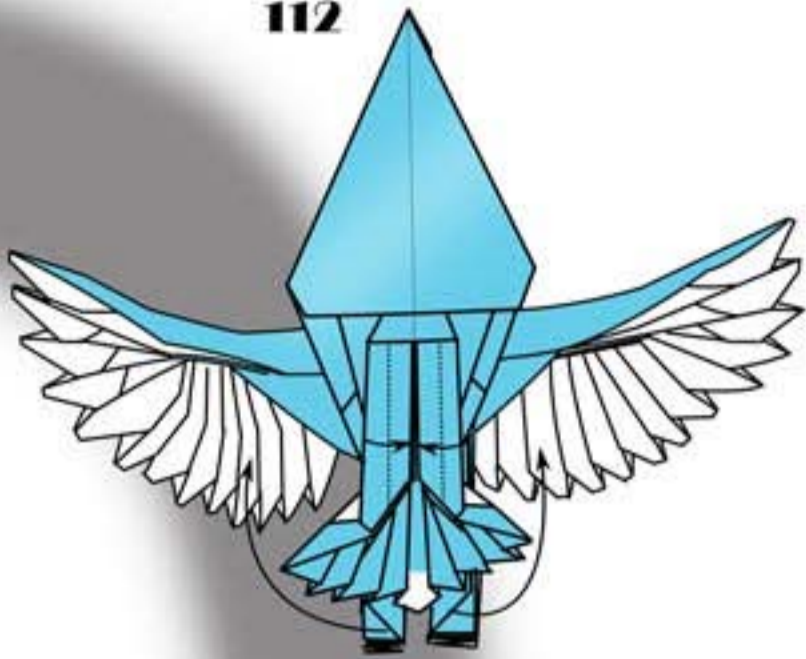

121 eagle completed

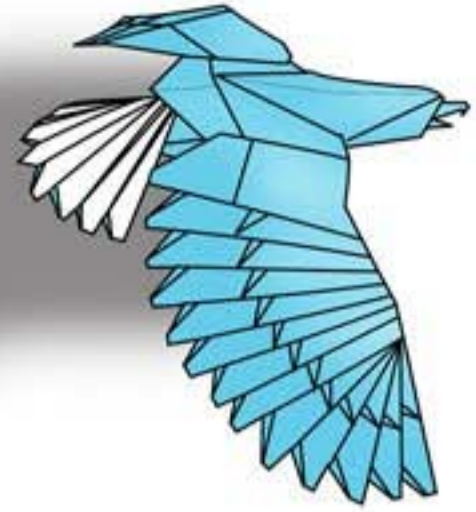

113

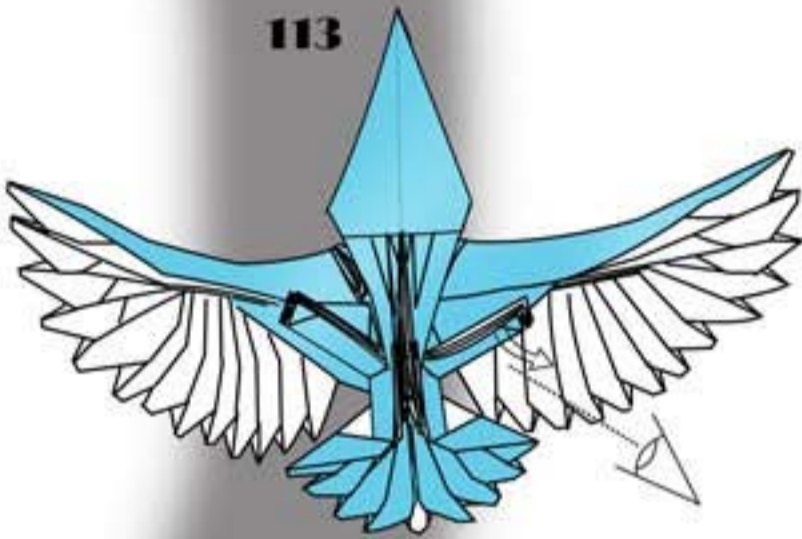

120



119

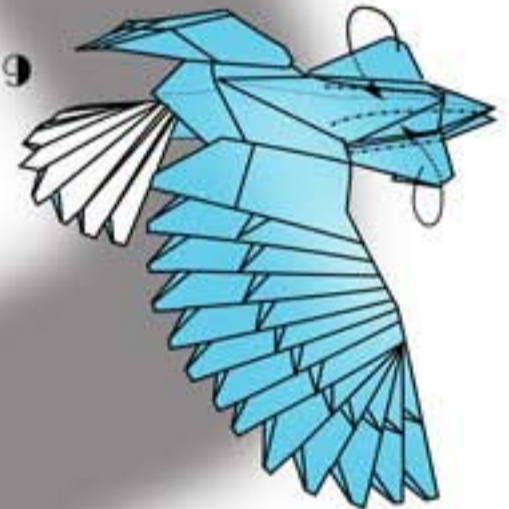

114



118

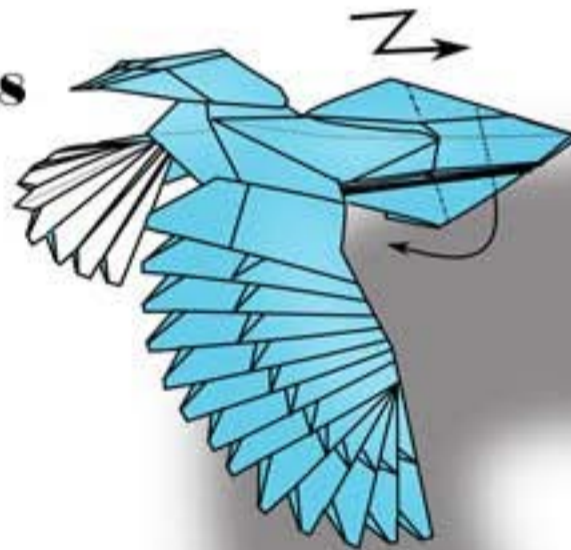

115

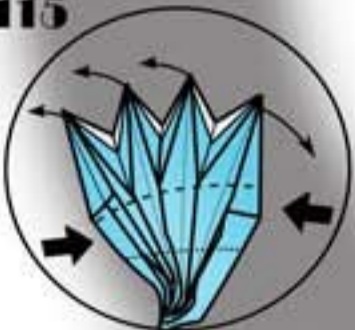

117

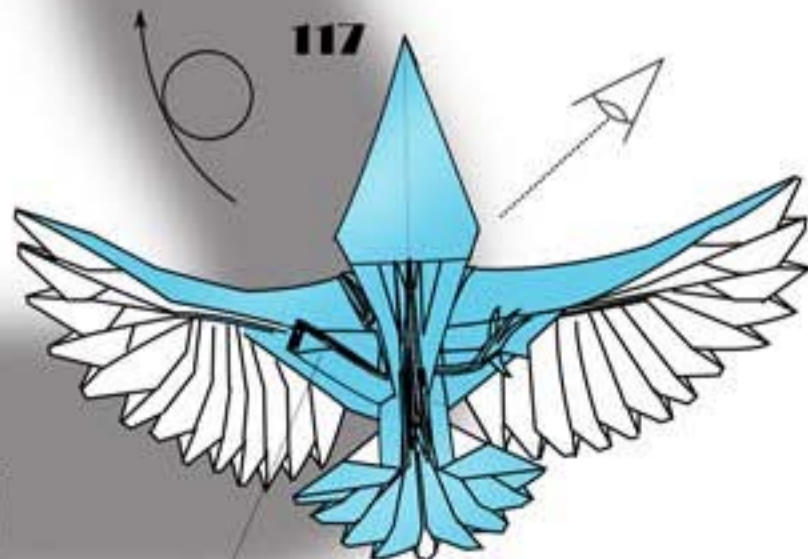

116



repeat steps 113-116  
for other leg